

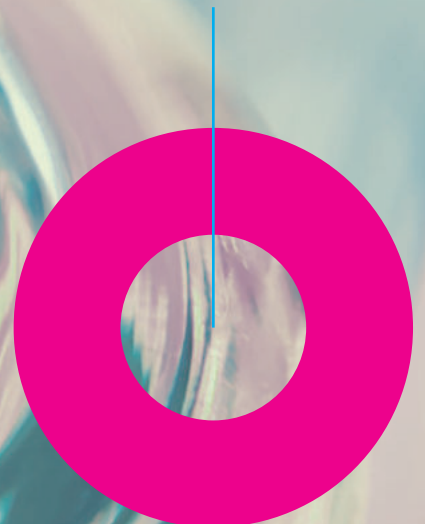

Your needs, our innovations

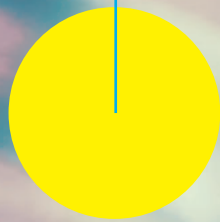

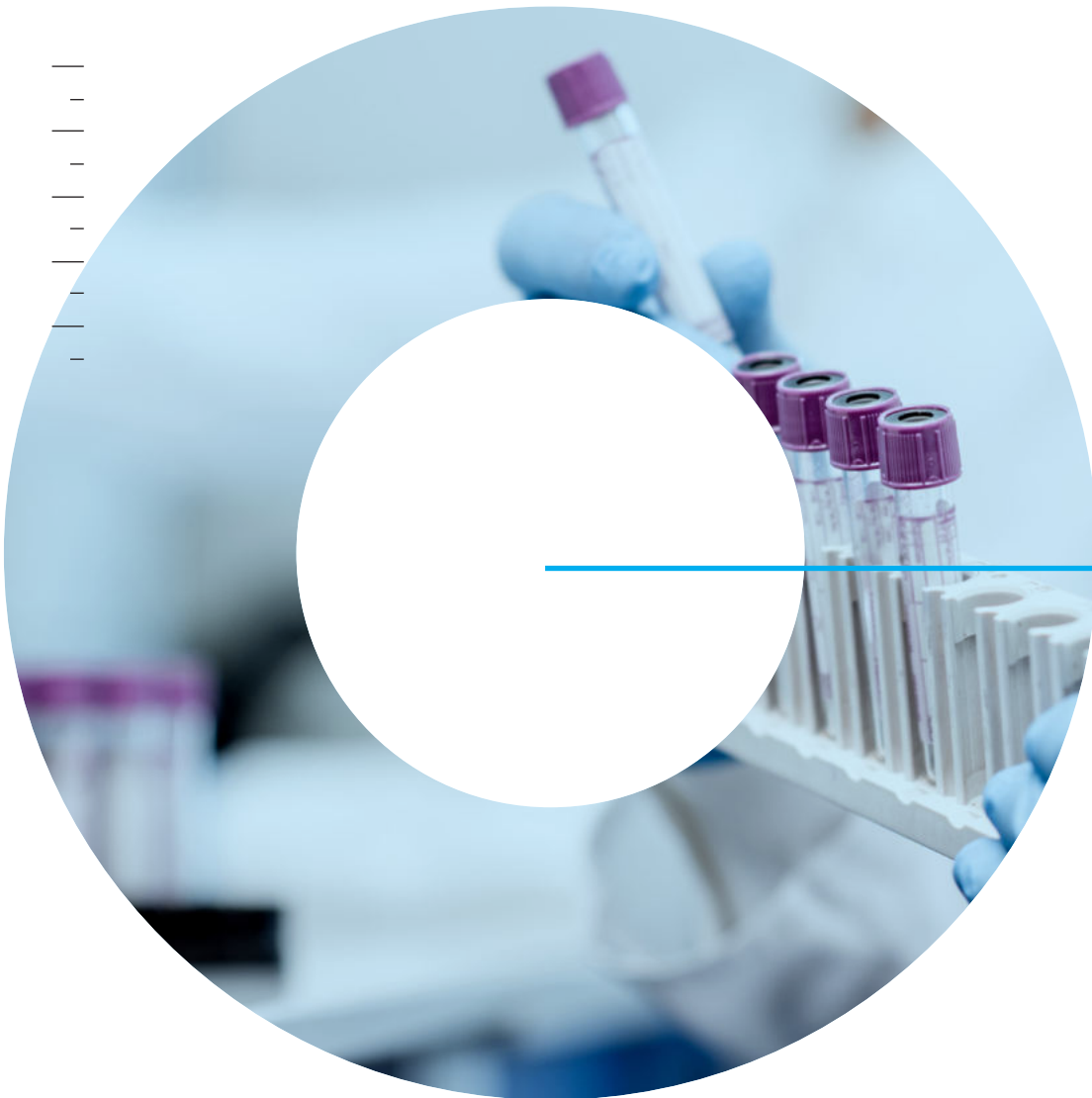

www.deltalab.es



General: info@deltalab.es
Marketing: marketing@deltalab.es



Plaza de la Verneda, 1 (Pol. Ind. La Llana)
Apartado de Correos 195
08191 RUBÍ (BARCELONA)
ESPAÑA



+ 34 93 699 50 00



+ 34 93 699 45 12



Dear customers, distributors, suppliers and friends,

It is again a pleasure to be able to address all of you through this new edition of DELTALAB's Catalogue.

A Catalogue that highlights the work done by our company in these more than 40 years, and that wants to respond to the needs of our customers.

Our well known company philosophy: innovation, quality, service and efficiency, has been and will be always linked to our daily work, with a clear final objective: our customers' satisfaction.

At the doors of the beginning of a new decade our market continues to show solidity, being naturally an evolving market. The increasing automation of processes and the search for higher speed and reliability in diagnosis are clearly influencing the demand for new solutions. Finding the right scale to grow in this new competitive environment, increasing investment in R&D, developing our production and operational processes in search of higher productivity, adapting the forthcoming regulatory changes are some of the challenges that as of today, we are facing them and will be decisive to continue competing for the future of our market.

From Deltalab, we take these new challenges with the same enthusiasm that we have put through all these years, and we will redouble our efforts to continue having the best solutions for our clients. For this, we want to count, as always, with your invaluable collaboration. Your success will be ours too.

We hope that this new edition of our Catalogue will help us to meet our common objectives and be the tool that gives us the key to this near future success.

José Sáez Mateos
CEO

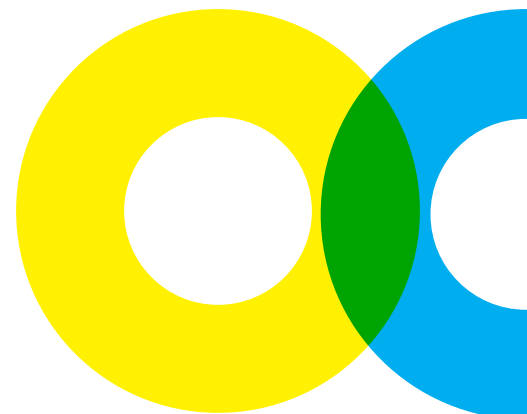

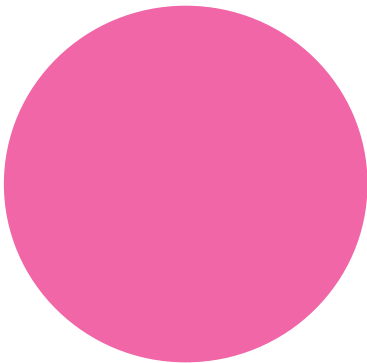
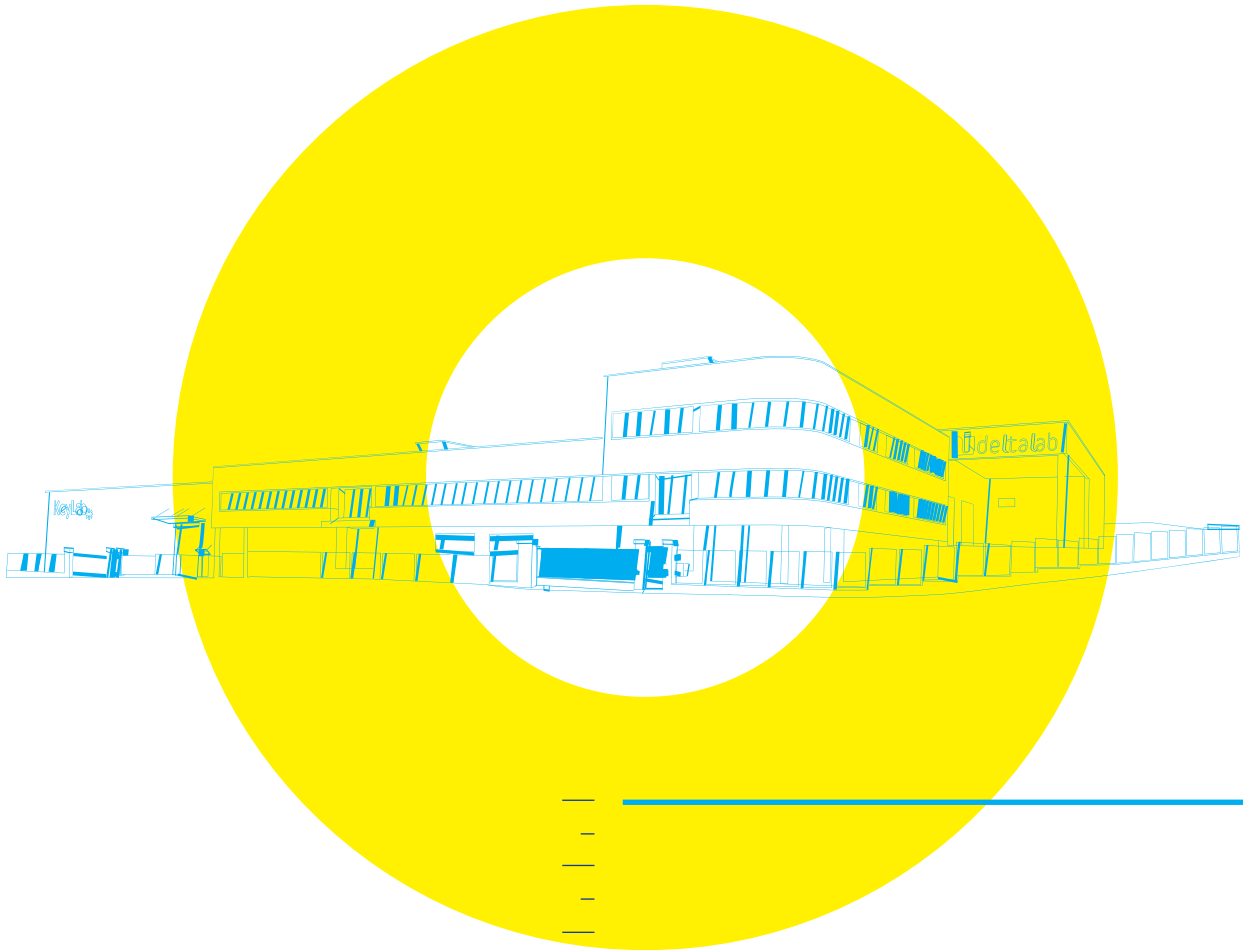

**CERTIFICATIONS OF THE INTEGRATED MANAGEMENT SYSTEM
(quality and environment)**



ISO 9001: 2015
Quality management systems.



ISO 13485:2016
Medical devices.
Quality management systems.
Requirements for regulatory purposes.



ISO 14001: 2015
Environmental management systems

DELTALAB ISO CERTIFICATIONS

Deltalab's Quality Management System is certified as per ISO 9001:2015 and ISO 13485:2016 standards.

Since August 2019, Deltalab has been granted the **ISO 14001:2015 Certification**. This standard ensures that our companies have an Environmental Management System, which allows us to control the environmental impact of our products and activities. Deltalab, being a company **committed with the environment protection**, has decided to implement the mentioned Environmental Management System to reduce as much as possible the environmental impact.

The plastic materials of the products manufactured and commercialized by Deltalab are of high quality and are adequate to the needs of every product. For example, they are suitable for food contact, free of latex and other harmful substances such as heavy metals, phthalates, bisphenol or asbestos. Provided the products made of plastic are not chemically polluted, they are fully recyclable and biodegradable, and must be disposed of following the law in every country.

The packaging cardboard materials used in for the products commercialized by Deltalab are biodegradable and recyclable. To ensure a responsible management of the natural resources, these materials follow the FSC guidelines.

CE MARK OF MEDICAL DEVICES (MD) AND MEDICAL DEVICES FOR IN VITRO DIAGNOSTICS (IVD)

The CE Mark concerns those products that, affecting human beings, may involve a risk to their health. Therefore the CE Mark warrants that a product has been designed and manufactured so that it complies with the following requirements:

- **Does not compromise the health or clinical status of a patient.**
- **Does not endanger the user's health or safety.**
- **Does not compromise the health or safety of third parties.**
- **Minimizes the risk of errors of use thanks to its ergonomic features and the environment in which it is intended to be used.**
- **It takes into account the technical knowledge, expertise, experience, training, and medical and physical conditions of the intended users.**

The CE Mark requires that facilities, work organisation, and systems are subject to rigorous both internal and external quality controls. It also guarantees the highest level of safety when using those products intended for the sample collection and handling of human samples, directly and also for taking human clinical samples and their subsequent in vitro diagnosis.

The CE Mark guarantees that the products will be freely commercialised within the European Union.

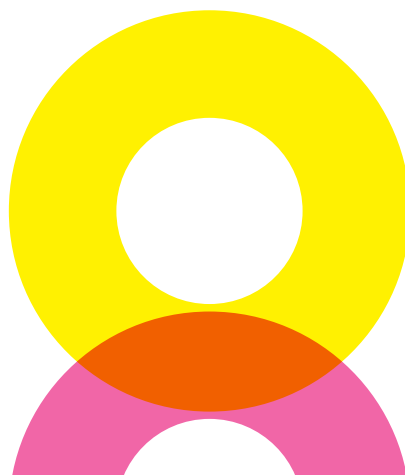

1.

MEDICAL DEVICES (MD)

According to Regulation UE N° 2017/745 on Medical Devices (that will replace Directive 93/42/CEE) a Medical Device is any instrument, apparatus, appliance, software, implant, reagent, material or other article intended by the manufacturer to be used, alone or in combination, for human beings for one or more of the following specific medical purposes:

- Diagnosis, prevention, monitoring, prediction, prognosis, treatment or alleviation of disease,
- Diagnosis, monitoring, treatment, alleviation of, or compensation for, an injury or disability,
- Investigation, replacement or modification of the anatomy or of a physiological or pathological process or state,
- Providing information by means of in vitro examination of specimen derived from the human body, including organ, blood and tissue donations, and which does not achieve its principal intended action by pharmacological, immunological or metabolic means, in or on the human body, but which may be assisted in its function by such means.

This Regulation, that will enter into force in May 2020, establishes 4 categories of medical devices, depending on the risk (time of contact and invasivity). DELTALAB manufactures and commercialises products of transient use classified as **Class I (sterile and non-sterile) and Class IIa:**



Class I (Non sterile):

Low risk, invasive medical devices

It includes: non sterile tongue depressors, speculums, etc. Inspection gloves are considered both as MD Class I and PPE (Personal Protective Equipment). All of them are self-certification products, so No Notified Body is required.



Class I (sterile):

Low risk, sterile, invasive medical devices

Among others: sterile tongue depressors, sterile Ayre spatulas, sterile cytology brushes, flocked swabs with and without transport media. They are certified by a Notified Body.



Class IIa (sterile):

Moderated risk, sterile surgically invasive medical devices

Swabs with and without medium are included in this Class. They are certified by a Notified Body. **The CE Mark allows these swabs to be used in surgical operations as an invasive product.**

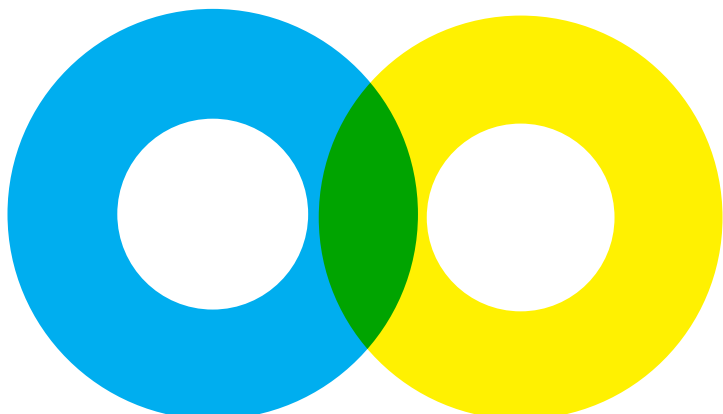

2.

MEDICAL DEVICES FOR IN VITRO DIAGNOSTIC (IVD)

According to Regulation EU N° 2017/746 on medical devices for in vitro diagnosis (that will replace Directive 98/79/EC), an in vitro medical device is “any medical device which is a reagent, reagent product, calibrator, control material, kit, instrument, apparatus, piece of equipment, software or system, whether used alone, solely or principally for the purpose of providing information on one or more of the following:

- concerning a physiological or pathological process or state;
- concerning congenital physical or mental impairments;
- concerning the predisposition to a medical condition or a disease;
- to determine the safety and compatibility with potential recipients;
- to predict treatment response or reactions;
- to define or monitoring therapeutic measures.

Specimen receptacles shall also be deemed to be in vitro diagnostic medical devices;

Specimen receptacles means a device, whether of a vacuum-type or not, specifically intended by its manufacturer for the primary containment and preservation of specimens derived from the human body for the purpose of in vitro diagnostic examination. Examples: Urine analysis bottles, blood extraction tubes, tubes with means of transport for combined use with swabs, capillaries, enrichment media, etc.

Medical Devices for in vitro diagnosis are not considered material for general laboratory use .

3.

PPE PRODUCTS (Personal Protective Equipment)

According to Regulation EU N° 2016/425m that repeals Directive 89/686/EEC, a PPE product is “any device or system to be worn or used by a human being, which protects him from one or various risks that may endanger his health and/or security”.















USEFUL INFORMATION

PRODUCT PACKAGING

SYMBOLS USED IN LABELING AND INFORMATION ON MEDICAL DEVICES

(in accordance with UNE-EN ISO 15223-1: 2016)



	Manufacturer		Do not use if package is damaged
	Use-by date		Temperature limit
	Batch code		Do not reuse
	Catalogue number		Consult instructions for use
	Sterilized using aseptic processing techniques		Caution
	Sterilized using ethylene oxide		In vitro diagnostic medical device
	Sterilized using irradiation		

TRANSPORT

CONTAINERS: CAPACITY:

-  · 20 feet: 28 m³ maximum
-  · 40 feet: 58 m³ maximum
-  · 40 HC feet: 68 m³ maximum

PALLETS:

-  · maximum height land transport: 2.40 m
-  · maximum height sea transport: 2.10 m
-  · width x depth european pallet: 80 x 120 cm

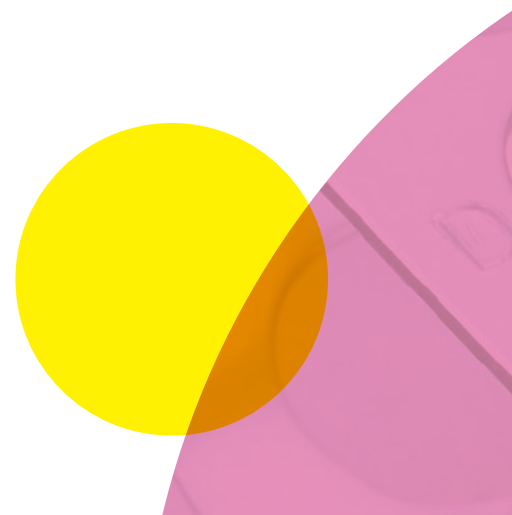

SALES CONDITIONS

- Goods are shipped at the purchaser's risk and on the purchaser's account.
- Goods are considered delivered, and at the responsibility of the purchaser, from their shipment from our warehouses. Any problem of transport or other is therefore the entire responsibility of the purchaser from that moment.
- Goods delivered are the property of DELTALAB S.L. until paid in full. In case of discrepancy, we will be governed by the courts of Barcelona.
- **MINIMUM ORDERING QUANTITY** (per total order): According to our price list.
- **MINIMUM ORDER QUANTITY** (per product): In those products indicated, it is possible to acquire minor quantities from the standard selling unit. In those cases, a surcharge is applied in order to cover the manipulation costs. Orders over the standard selling unit must be multiple of this standard selling unit. Orders must be in complete case quantities unless indicated otherwise.
- **ORDERS:** should be confirmed in writing, stating our code number, description, total quantity and referring to any quotation number that may apply. In case of doubt the code number will have always preference over its description.
- **CLAIMS AND RETURNS:** Any claim on the items in our catalogue must be made in writing within the deadlines indicated in the current price rate and its return requires the prior authorization of Deltalab. The customer must indicate the code, lot and delivery note number of the product subject to the claim.

Returns of products with sterile CE marking or items made of materials suitable for contact with food are not accepted.

- **PACKAGING:** Our products are properly packaged and coded (code, description, quantity and lot number). This catalog indicates weights and volumes in kilograms and cubic meters.







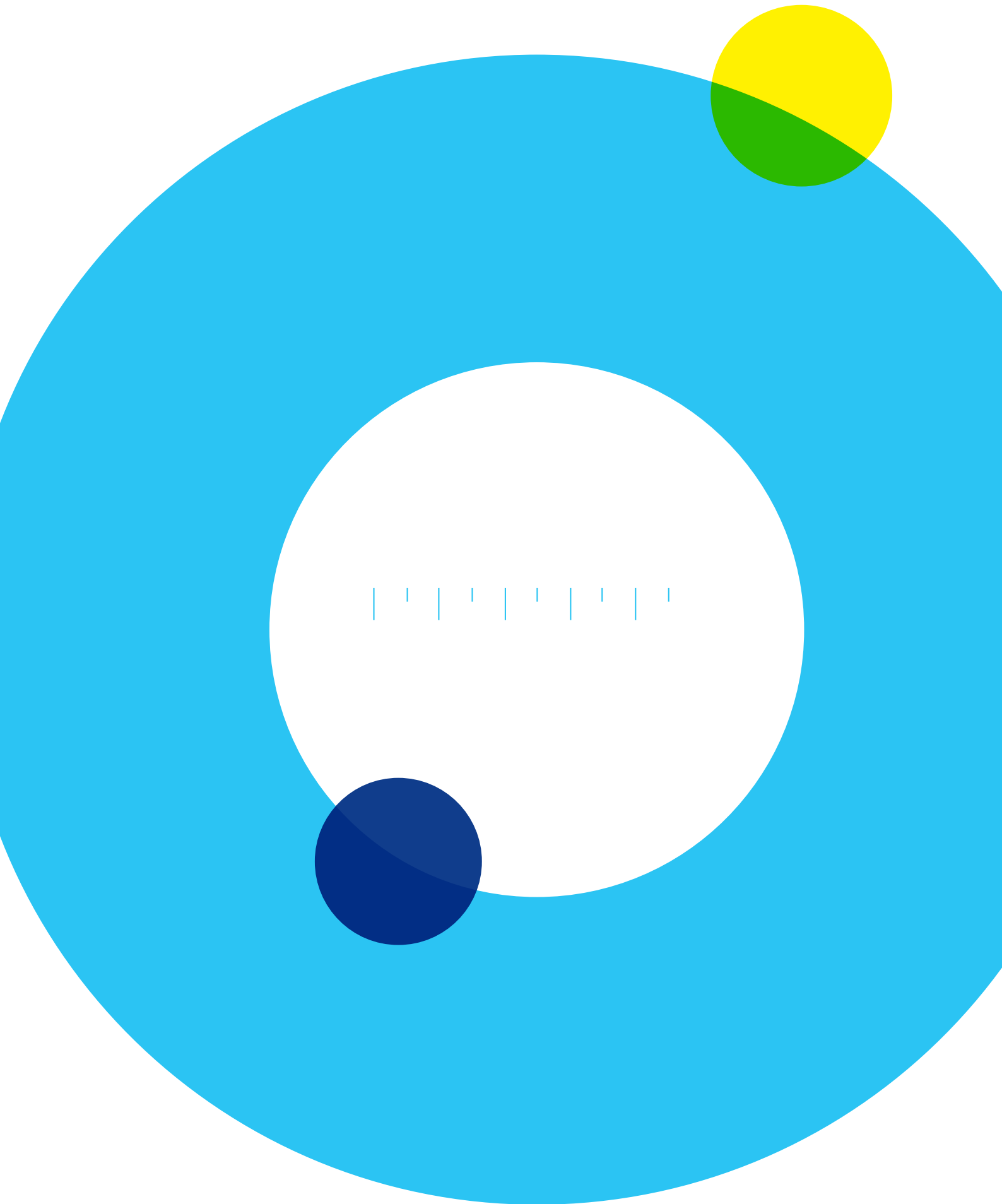



For reasons which are beyond our control we reserve the right to modify the product specifications.











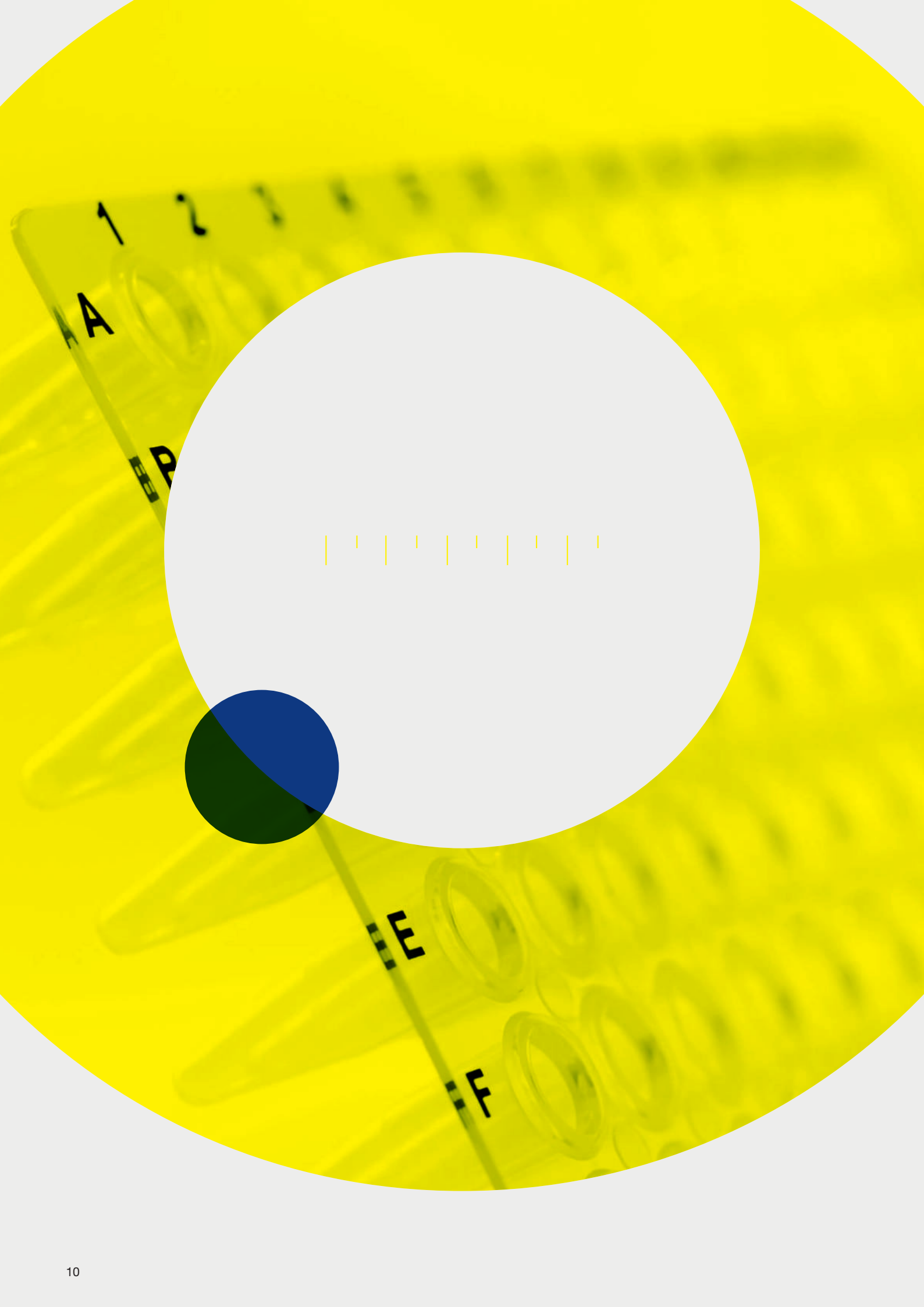





- 

Stackable
- 

Graduated
- 
Alphanumerical Identification
- 
Floats
- 
DNase and RNase free
- 
Autoclavable
(see more information about autoclaving in page 298)
- 
Suitable for PCR
- 
Suitable for QPCR (Real Time PCR)
- 
High resistance tube
- 
Packaged in bags
- 
Product suitable for food use
- 
New
- 
Directive 98/79/EC or Regulation 2017/746
(in Vitro Diagnostic medical device)
- 
Directive 93/42/EEC or Regulation 2017/745
(low risk medical device)
- 
Directive 93/42/EEC or Regulation 2017/745
(Moderate risk, sterile medical device)
- 
Directive 89/686/EEC
(Personal protective equipment)

The technical data (dimensions, capacities and resistances) specified in this catalogue are approximated.
 The resistances (to chemical products, temperature, centrifugation...) may suffer variations depending on external conditions.
 We recommend to test the product under the forecasted conditions of use. Please do not hesitate to ask for samples if necessary.



|||||

12	Microbiology	
50	Cell culture. Molecular biology	
72	Haematology. Biochemistry	
90	Histology. Microscopy and staining	
114	Containers. Sampling	
140	Tubes, microtubes and cryovials	
162	Cold storage	
176	Liquid handling	
208	Sample storage	
240	Hygiene, safety and general labware	
274	Laboratory and industrial packaging	
294	Technical information	
302	Index	





MICROBIOLOGY



SWABS FOR MICROBIOLOGICAL SAMPLING

- Swabs are used for biological sampling.
- Specially used for processing samples which, after being coloured, will be analysed by microscopy.
- Also suitable for isolations in culture medium.
- Another important use is its capacity to spread dishes by dissemination techniques (for example for susceptibility testing by Kirby-Bauer or by E-test).

SWABS

The swabs intended for the collection and transport of microbiological samples are considered invasive medical devices for temporary use. As such, they comply with the safety and performance requirements determined by EU Regulation 2017/745 (which will replace Directive 93/42 / EEC on medical devices in May 2020).

According to the rules of classification of this Regulation these swabs belong to class IIa since they are of surgical use.

The **Agencia Española del Medicamento y Productos Sanitarios** (AEMPS – ON 0318) is the institution who certifies these swabs.

QUALITY STANDARDS – REQUIREMENTS FULFILLED BY SWABS

- | | |
|---|--|
| <ol style="list-style-type: none"> 1. UNE-EN ISO 556-1 Sanitary products sterilisation. Requirements to be designed as “STERILE”. Part 1: sterilised sanitary products requirements. Requirements for medical devices in their terminal state. 2. UNE-EN ISO 868-2 Packaging materials for medical devices sterilized in its final phase. Part 2: sterilization wrap. Requirements and test methods. 3.* UNE-EN ISO 11737-1 Sterilization of medical devices. Microbiological methods. Part 1: determination of a population of microorganisms. 4.* UNE-EN ISO 11737-2 Sterilization of medical devices. Microbiological methods. Part 2: Sterility tests performed for the definition, validation and maintenance of a sterilization process. 5.* UNE-EN ISO 11135-1 Sterilization of medical devices. Ethylene oxide. Part 1: requirements for development, validation and control of the routine of a sterilization process of medical devices. | <ol style="list-style-type: none"> 6.* UNE-EN ISO 11137-1 Sterilization of health care products. Radiation. Part 1: requirements for the development, validation, and control of the routine of a sterilization process of PS. 7.* UNE-EN ISO 11137-2 Sterilization of health care products. Radiation. Part 2: setting the sterilization dose. 8. UNE-EN ISO 15223-1 Sanitary products. Symbols to use on labels, labelling and information to be supplied. Part 1: general requirements. 9. UNE-EN ISO 14971 Sanitary products. Application of risk on management. 10. UNE-EN ISO 13485 Sanitary products. Systems of quality management. Requirements for regulatory purposes. |
|---|--|

* These rules apply to sterile swabs.



SWABS USE ACCORDING TO THE MATERIAL

SWAB HEADS

Are made of various materials, including cotton, polyester and viscose. Each swab contains more or less 0.04g of fiber and its absorption capacity is 0.2-0.3ml, with cotton usually having a better absorption of liquid, although the difference is minimal.

Cotton/Pure Cotton:

Fibrous substance, white and soft. Being a vegetable fiber can include traces of some substance (fatty acids, oils, etc.) that affect labile or demanding microorganisms.

Polyester (Dacron):

For use in direct antigen, PCR, IFA tests. Its drawback is that it contains fatty acids and inhibitory detergents. It has flame retardant properties.

Viscose (Rayon):

Artificial silk obtained from cellulose. It is a more aseptic material and the one with less effects inhibitory has in bacterial growth. Therefore, it is the best material for cell recovery.

Flocked polyester:

Material with high absorbency and overall sample elution.



SWABS SHAFT

The shaft is available in different materials according to its application: In wood, in polystyrene (breakable without leaving splinters) and also in aluminium.

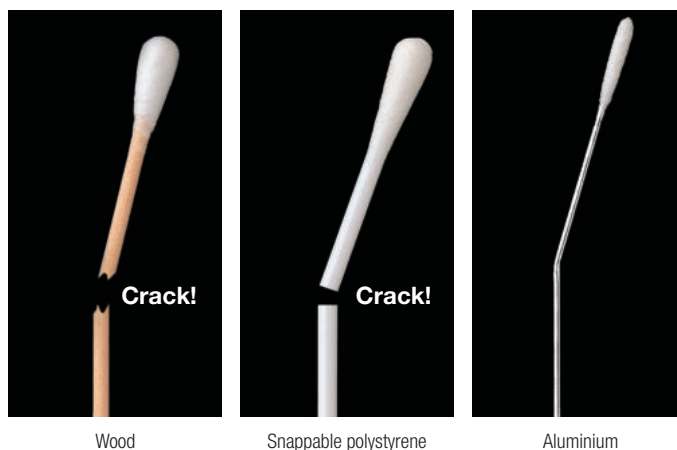

Wood

Snappable polystyrene

Aluminium

PRESENTATIONS



In bulk:
the non-sterile swabs
presented in bags of 100 units.



Peel-pack package:
Plastic unit bag - plastic or
medical paper - plastic
(according to reference).



Flow-pack package:
single bag. Polypropylene
bioriented bag.



Package in polypropylene tube:
On the label that acts as a seal,
the product is identified.

All sort of package have the following parameters printed on: product code, product description, lot number, expiry date, CE mark, manufacturer name and address, sterilisation method and single use mark (Ⓜ).

TRADICIONAL SWABS WITHOUT TRANSPORT MEDIUM

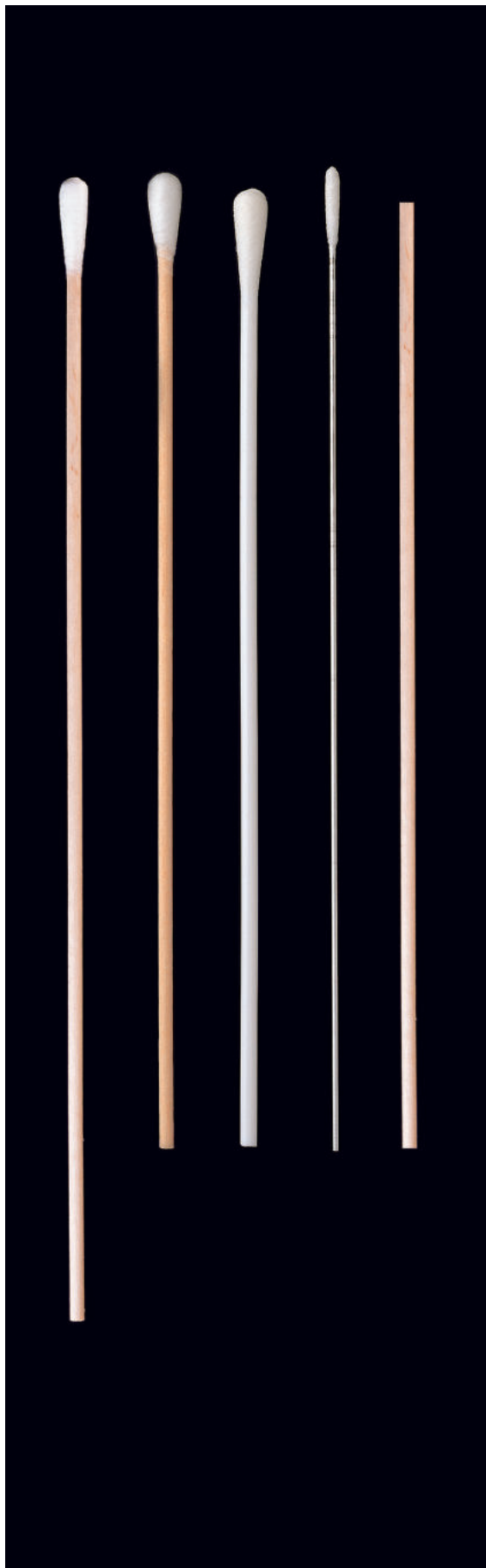

Non sterile swabs

Model **300232** is longer than the traditional swabs and is designed for those hard to reach places.

For use in **gynaecology** when taking endocervical cells while using the speculum.

Dimensions:

300232 shaft 200 x 2.5 mm. Tip 5 mm Ø.

300205 shaft 147 mm ± 0.3 mm x 2.2 mm ± 0.3 mm Ø.

Other models dimensions:

Wood: shaft 150 x 2.2 mm (tip Ø ± 5 mm).

Polystyrene: shaft 150 x 2.5 mm (tip Ø ± 5 mm).

Aluminium: shaft 147 x 0.9 mm (tip Ø ± 1.5 mm).

They are supplied in bags of 100 units, excepting code **300205**, supplied bulk.



code	shaft material	tip material	case quantity	case weight	case volume
300232	extra large wood (200 mm)	cotton	80 x 100	5.0	0.032
300230	standard wood (150 mm)	cotton	100 x 100	4.65	0.032
300260	polypropylene	cotton	40 x 100	2.5	0.012
300260.1	polystyrene	viscose	40 x 100	2.5	0.014
300243	aluminium	cotton	100 x 100	2.8	0.005
300205*	wooden shaft only	-	1 x 1,000	2.5	0.010

* Non CE product.

Expiry date: 60 months

Sterile swabs

Sterile swabs individually wrapped in peel-pack or flow pack, depending on the model. **Sterilized.**

For use when samples do not need to be transported.

It is recommended our transport swabs in tubes when sample transport is required (see next page).

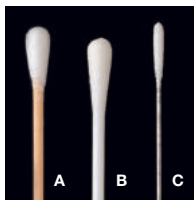

A: Wood
B: Snappable polystyrene
C: Aluminium

code	shaft material	tip material	sterile	package	case quantity	case weight	case volume
300200	wood	cotton	STERILE R	peel-pack	2 x 1,000	2.25	0.029
310200	wood	cotton	STERILE R	flow-pack	2 x 1,000	2.60	0.029
300201	snappable PS	cotton	STERILE R	peel-pack	2 x 1,000	3.52	0.027
300202	snappable PS	viscose	STERILE R	peel-pack	2 x 1,000	3.50	0.029
310202	snappable PS	viscose	STERILE R	flow-pack	2 x 1,000	2.02	0.029
300203	aluminium	cotton	STERILE EO	peel-pack	2 x 1,000	2.40	0.029

Cases per pallet: 54.

Expiry date: 48 month from sterilization date.

1. Flow-pack
2. Peel-pack



Sterile swabs (2 units)

Two Sterile swabs wrapped in peel-pack, depending on the model. **Sterilized by ethylene oxide.**

One swab is designed for cleaning the sampling area.

The other swab is designed for sample collection.

For use when samples do not need to be transported.

It is recommended our transport swabs in tubes when sample transport is required 1,000 peel-packs with 2 units each one per case.

code	shaft material	tip material	sterile	package	case quantity	case weight	case volume
300210	wood	cotton	STERILE EO	peel-pack	1.000	2.65	0.024
300212.1	snappable PS	viscose	STERILE EO	peel-pack	1.000 peels	2.72	0.025



Cases per pallet: 54.

Expiry date: 48 month from sterilization date.

Medical paper+ plastic



Sterile swab in round tube

Sterile dry swabs supplied in shockproof round bottom polypropylene tube, with a label sealing the cap.

Dimensions of tube: Ø 13 x 165 mm.

Sterilised by ethylene oxide.

code	shaft material	tip material	case quantity	case weight	case volume	cases per pallet
300250	wood	cotton	4 x 500	14.00	0.060	24
300250.1	wood	pure cotton	4 x 500	14.00	0.070	24
300261	snappable PS	cotton	4 x 500	14.90	0.070	24
300252	snappable PS	viscose	4 x 500	15.00	0.066	24
300263	snappable PS	poliéster	4 x 500	15.00	0.062	24
300251	aluminium	cotton	4 x 500	15.00	0.066	24
300253	aluminium	viscose	4 x 500	13.90	0.070	24
300265*	PS	flocked polyester	4 x 500	14.20	0.065	24

Expiry date: 48 month from sterilization date.

*Code not available for sale in Italy, UK and Ireland. Class I Sterile product"



Flocked polyester: material with high absorbency and overall sample elution.

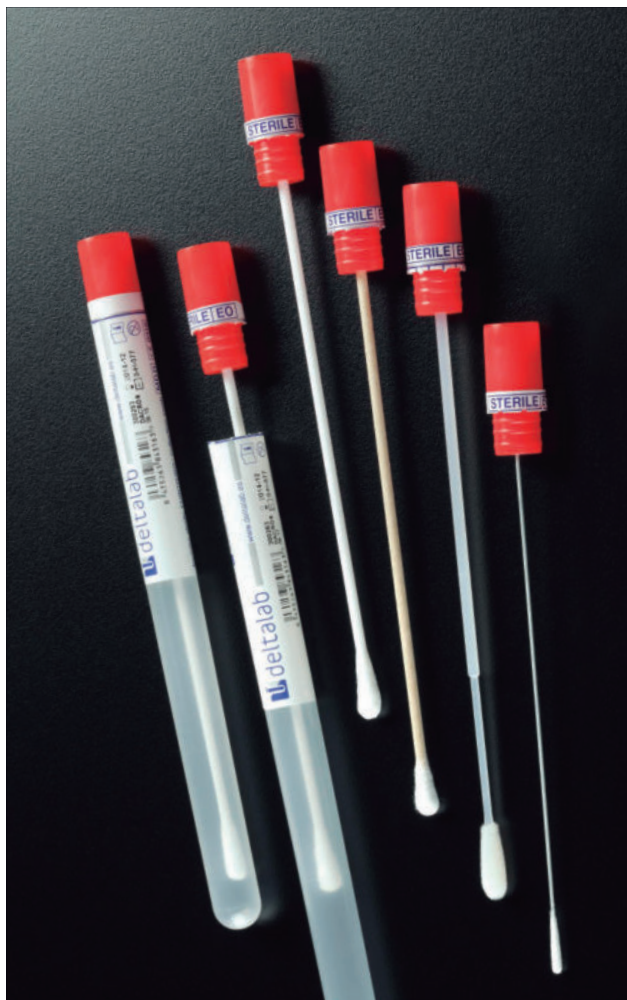

Human DNAsa, RNAsa and DNA free certified swabs, steriles

Human DNA free Certified. **Sterilised by ethylene oxide.**

The swab is supplied in a polypropylene tube, which protects the sample up to the laboratory prior to its analysis. The stick of the swab is made of polystyrene while the head is produced with viscose or polyester according to the code. The tube is labeled indicating code, description, lot, expiry date and providing an identifying area to note down collection details (site, date, etc.). Moreover, the label seals the tube with the cap of the swab, acting like a tamper evident system.

code	shaft material	tip material	selling unit	case quantity	case weight	case volume
300252DNA	polystyrene	viscose	500	4 x 500	14.20	0.070

Expiry date: 48 months from sterilisation date



This product is not considered a medical device and does not carry CE marking because it is not for a subsequent diagnosis of a pathology, but is designed for saliva sampling, for genetic analysis (identification of human DNA) within the scope of the investigation and the forensic market.



TRANSPORT SWABS WITH MEDIA

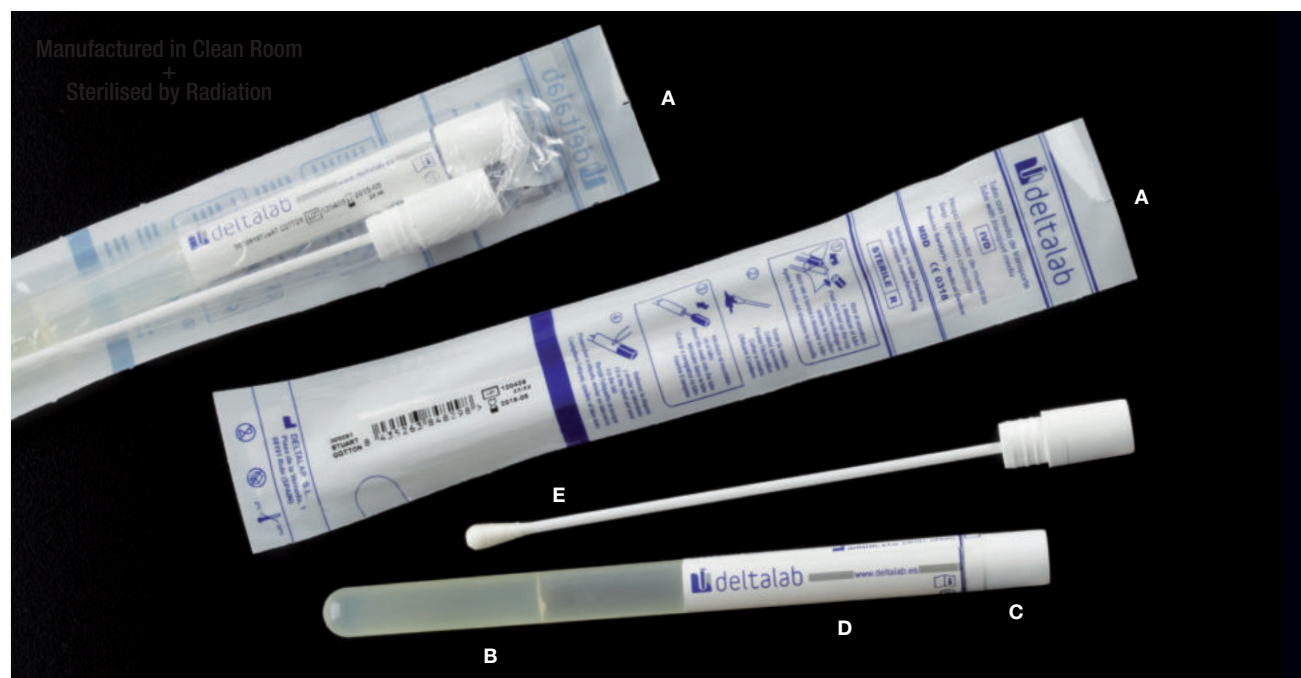

Safety

- Paper less, plastic peel-pack is an extraordinary safe system to maintain pack integrity and sterility

Comfort

- Space saving
- Collapsible internal case
- Easy warehouse identification
- Selling unit easy to commercialize
- New standardised pack quantity for all our swabs
- The peel-pack has a small slit at the top to allow easy opening

Information

- Full range of transport medias listed on the package
- Clear dual CE Marking IVD + MDD printed in both, peel-pack and case
- User's guide provided in both, peel-pack and case

Design

- Attractive peel-pack and friendly users guide
- Eye-catching case designed exclusively for swabs
- Drawings of a swab and a tube on both the peel-pack and the case for first sight identification

Traceability

- Each single peel-pack is printed with the catalogue number, bar code, lot number, expiry date and product description
- Both external and internal cases are also identified with catalogue number, bar code, lot number, expiry date and product description

Environmentally friendly

- Peel pack made of one material only: easy recycling!

CE SWABS

As the two main components of a transport swab have different purposes and different ways of interaction with the patient, both have different CE treatment:

1. **Swab:** for microbiological sample collection. As a surgical invasive product of temporary use, is classified as CLASS IIa product in compliance with EU Regulation 2017/745 (which will replace Directive 93/42/EEC).
2. **Tube with transport media:** container facilitator of survival and transport of biological samples prior to analysis. Classified as in vitro diagnostic IVD (according to EU Regulation No. 2017/746, which will replace Directive 98/79/EC).

TRANSPORT MEDIA

The media used to transport the sample, has the appropriate chemical composition that maintains the bioburden levels with the minimum physiological activity, achieving thus the minimal quantitative and qualitative variation of the sample from the collection to its analysis.

COMPONENTS

Each set consists in a tube and a swab, packed in a peel-pack bag (A) and sterilised by radiation.

- (B) **Tube with transport media:** Made of rigid polypropylene with round bottom.
- (C) Polyethylene **cap** specially designed to close hermetically; non slippery surface when using gloves.
- (D) Coloured **label** in each tube with the following parameters printed: transport media type, sterilisation method, manufacturer name, CE mark, "single use" and "see the instructions" marks, lot number and expiry date, as well as spaces to write patient name, date, time, medical report number, source and kind of sample. The label seals the cap and the tube.
- (E) **Swab** fitted in a second cap with a shaft which ends in a tip of synthetic or organic material hardly adhered to the shaft. The cap provides a leakproof seal after sample collection.

Both the peel-pack package and the label of the tube are printed with the following information: transport media type, sterilization method, manufacturer name, **CE** mark, "single use" and "see the instructions" marks, lot number, and expiry date. Peel pack also includes bar code.

Amies. Sterile

It is the universal means for transporting bacteria in microbiological samples. It is a modification of the medium of Cary Blair, itself of the medium Stuart. Basically, change glycerophosphate for inorganic phosphate and methylene blue for neutral pharmaceutical coal. In addition, it adds calcium and magnesium ions, which help preserve the permeability of the bacterial cell. This media assures the viability of organisms such as:

- Neisseria sp.
- Haemophilus sp.
- Corynebacterium sp.
- Trichomonas vaginalis*
- Streptococcus pyogenes*
- Streptococcus pneumoniae*
- Shigella flexneri*
- Salmonella typhi*
- Brucella abortus*
- Enterobacterias, etc.

The presence of charcoal on the media neutralises inhibitors and bacterial toxins, and improves the recovery ratio of *Neisseria gonorrhoeae* and *Vibrio cholerae*

Some microorganisms can resist on the media for up to 3 days, although the recovery of microorganisms is better if cultured in the first 24 hours. Amies transport swabs are available with or without charcoal.

Swabs are sterilised by radiation.

Peel-pack dimensions: 38 x 210 mm.
Expiry date: 30 months.

code	shaft material	tip material	case quantity	case weight	case volume
300287	snappable PS	viscose	6 x 100	9.33	0.059
300285	snappable PS (with charcoal)	viscose	6 x 100	9.37	0.058
300281	aluminium	viscose	6 x 100	9.08	0.056
300281/1	aluminium (with charcoal)	viscose	6 x 100	9.15	0.052

Cases per pallet: 32.



Liquid Amies. Sterile

This is a variation of the traditional Amies media swab where the media is presented on liquid form without agar. Suitable for conservation of pathogens such as:

- Haemophilus sp.
- Corynebacterium sp.
- Trichomonas vaginalis*
- Streptococcus pyogenes*
- Streptococcus pneumoniae*
- Shigella flexneri*
- Salmonella typhi*
- Brucella abortus*
- Staphylococcus epidermidis*
- Escherichia coli, etc.

Media is supplied in its liquid form, in a sponge, suitable for direct extensions on slides.

Swabs are sterilised by radiation.

Peel-pack dimensions: 38 x 210 mm.
Expiry date: 30 months.

code	shaft material	tip material	case quantity	case weight	case volume
300284	snappable PS	viscose	6 x 100	7.60	0.055

Cases per pallet: 32.



Stuart swabs. Sterile

The modified Stuart media allows the conservation and transportation of a large number of pathological microorganisms, such as:

Neisseria gonorrhoeae
Haemophilus influenzae
Neisseria meningitidis
Bordetella pertusis
Corynebacterium diphtheriae
Trichomonas vaginalis
Staphylococcus aureus
 Streptococcus sp.
 Salmonella sp.
 Shigella sp.
 etc.

The most unstable organisms will remain viable for up to 24 hours and other for several days. The media is reduced due to the presence of thioglycolate, which diffcults the enzymatic reactions of the bacteria.

The multiplication of the bacteria is prevented due to the lack of nitrogen in the media.

Swabs are **sterilised by radiation**.

Dimensions of the peel-pack: 38 x 210 mm.

Expiry date: 30 months from sterilisation date.

code	shaft material	tip material	case quantity	case weight	case volume
300290	wood	cotton	6 x 100	9.40	0.057
300291	aluminium	cotton	6 x 100	9.10	0.057
300295	snappable PS	viscose	6 x 100	8.65	0.060

Cases per pallet: 32.



Cary Blair. Sterile

Cary Blair is another modification of Stuart media.

The glycerophosphate has been substituted by inorganic phosphate since glycerophosphate is a metabolite for some bacteria, so they could grow and disperse the pathogens amount.

The methylene blue has also been removed and the pH increased to 8.4. This is a media originally developed for faecal samples but is also used successfully for anaerobic transport, such as:

Neisseria gonorrhoeae
Vibrio cholerae
Vibrio parahaemolyticus
Haemophilus influenzae
Neisseria meningitidis
Bordetella pertusis
Streptococcus pneumoniae
Shigella flexneri
Pasteurella pestis
 Campylobacter Spp., etc.

Swabs are **sterilised by radiation**.

Dimensions of the peel-pack: 38 x 210 mm.

Expiry date: 30 months from sterilisation date.

code	shaft material	tip material	case quantity	case weight	case volume
300280	wood	cotton	6 x 100	8.50	0.052
300280.2	snappable PS	viscose	6 x 100	8.50	0.056

Cases per pallet: 32.



Media for virus. Sterile

This viral transport media preserves the specimen during transportation to the laboratory.

Suitable, among many others:

- Papiloma
- Pseudorrabia
- Influenza aviar (H7N1)
- Influenza A (H1N1) o H1N1/09 pandemic
- Suid herpesvirus, etc.

The media maintains the sample viable for up to 72 hours and in some cases for longer time.

The addition of antimicrobial substances inhibit the growth of bacteria and fungi. Ideal for nasal, pharyngeal, ocular, skin and mucus samples.

Media is supplied in its liquid form, in a sponge, suitable for direct extensions on slides.

Swabs are **sterilized by radiaton**.

Expiry date: 18 months.

code	shaft material	tip material	case quantity	case weight	case volume
300297	snappable PS	polyester	6 x 100	7.75	0.057
300294	aluminium	polyester	6 x 100	7.80	0.056

Minimum order quantity: 100 units.

Cases per pallet: 32.



Media for Chlamydia. Sterile

Liquid media, suitable for Chlamydia.

For cervical samples it is recommended to firstly use a dry swab to clear the cervical channel.

Media is supplied in its liquid form, in a sponge, suitable for direct extensions on slides.

Sterilised by radiaton.

Expiry date: 12 months.

code	shaft material	tip material	case quantity	case weight	case volume
300299	snappable PS	polyester	6 x 100	7.80	0.056

Minimum order quantity: 100 units.

Cases per pallet: 32.



FLOCKED SWAB WITH MEDIA

Range of kits for collecting and transporting microbiological samples in liquid medium as well as a new line of enrichment media, endeavouring to make microbiology departments and analysis laboratories' jobs easier.

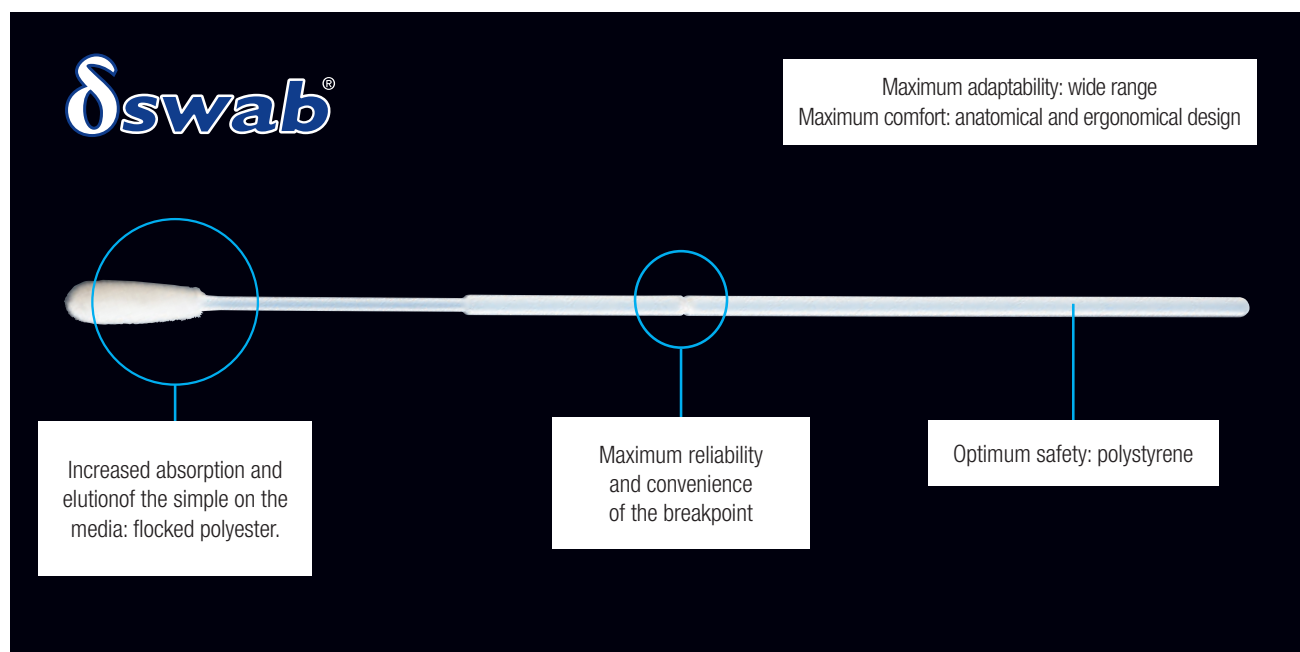

Advantages:

- Compatible with the new inoculation automatic systems and sample streaking equipment.
- Compatible with molecular diagnostic techniques.
- Facilitates the collection, transport and subsequent treatment of microbiological samples.
- Greater reliability for sample recovery: high capacity for the absorption and elution of the sample from the polyester flocked swab, developed by Puritan Medical.
- Greater feasibility of the sample as it is totally suspended in the medium.
- Allows different homogeneous inocula to be obtained from the same sample.
- It adapts to any working protocol.
- Minimises any possible cross-contamination: less handling and maximum watertightness.
- More comfort for the user: conical base which facilitates stirring and greater stability of the tube with skirt base.
- More comfort for the patient, due to the softer swab covering.
- Standardises the receipt of samples at the microbiology labs.
- Facilitates manual streaking.
- Allows direct extension on the glass slide for Gram staining, as the medium does not contain agar.
- Ensures proper sample transport and storage both at room temperatures (20°C - 25°C) and at refrigeration temperatures (4°C - 8°C).

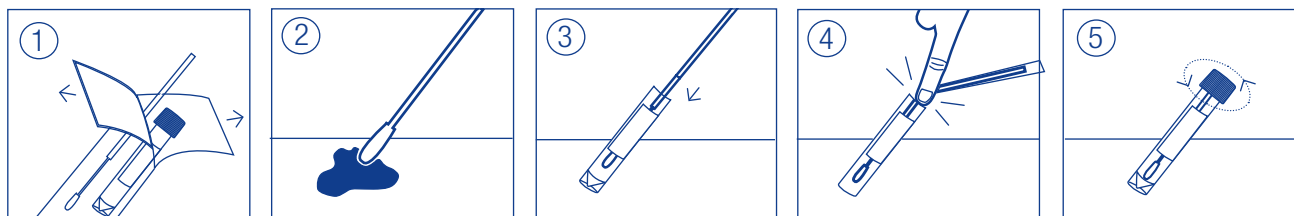

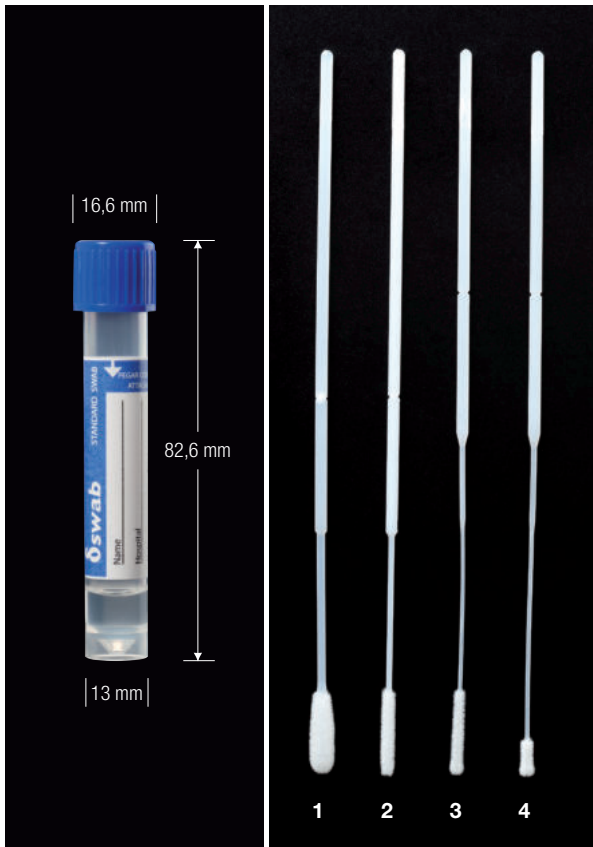

Amies

Particularly suited for microbiological sample collection and transport. It maintains the viability of Aerobes, Facultative Anaerobes and Anaerobes Bacteria for a minimum of 48 hours both at room temperature (20-25°C) and at refrigeration temperature (2-8°C) and 24 hours with Fastidious Bacteria, following CLSI Quality Control of Microbiology Transport System: Approved Standard - Second Edition. Designed both for traditional and automated sample streaking. Compatible with the molecular diagnostic techniques and for direct extension on glass slides.

Peel-pack package.

Sterilised by radiation.



mod.	code	ml	description	label colour	breakpoint mm	case quantity	case weight	case volume	
1	304281*	1	with standard flocced swab	●	80	6 x 100	5.7	0.056	
2	304282*	1	with standard flocced swab	●	80	6 x 100	5.6	0.056	
3	304285*	1	with nasopharyngeal flocced swab	●	100	6 x 100	5.6	0.056	
4	304286*	1	with minitip flocced swab	●	100	6 x 100	5.5	0.056	
NEW	1	304287*	2	with standard flocced swab	●	80	6 x 100	6.3	0.056
NEW	1	304288*	1	with 3 standard flocced swabs	●	80	6 x 100	6.6	0.052

*Code not available for sale in Italy, UK and Ireland. **Shelf life: 30 months.**

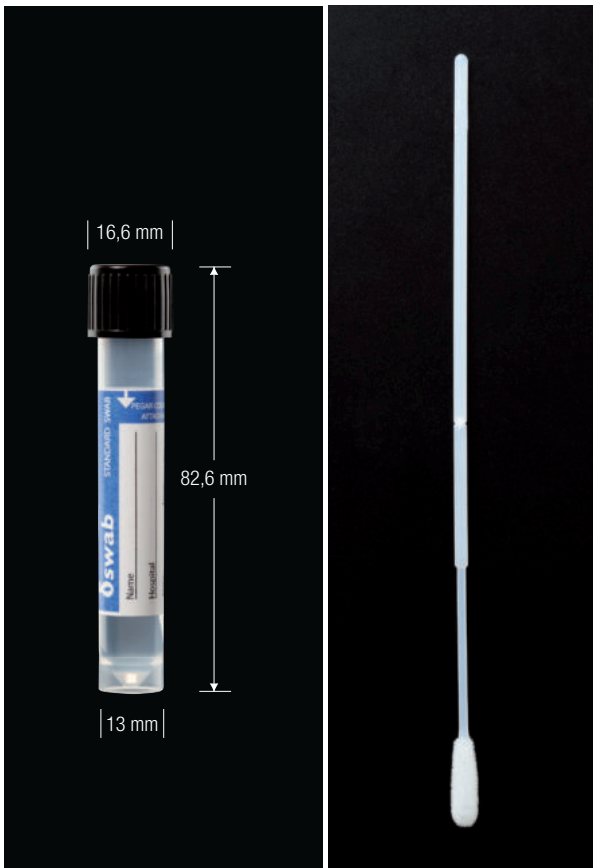

Cary Blair

Specially suited for the collection and transport of faecal samples. Maintains the viability of the fecal pathogens for a minimum of 48 hours without overgrowth, following CLSI Quality Control of Microbiology Transport System: Approved Standard - Second Edition. Designed for carrying out sample collection directly from the rectum or from faeces.

Designed for traditional and automated sample streaking. Compatible with the molecular diagnostic techniques by PCR and for direct extension on glass slides.

Peel-pack package.

Sterilised by radiation.



code	ml	description	label colour	breakpoint mm	case quantity	case weight	case volume
304280*	2	with standard flocced swab	●	80	6 x 100	6.3	0.056

*Code not available for sale in Italy, UK and Ireland. **Shelf life: 24 months.**

VicUM®

Particularly suited for collecting and transporting microbiological samples which contain Virus, Chlamydia, Ureaplasma and/or Mycoplasma. Includes antibiotics which inhibit the growth of Bacteria and Fungi; this ensures reliability in terms of sample recovery. Maintains the infectability of viruses for a minimum of 96 hours both at room temperature (20-25°C) and at refrigeration temperature (2-8°C), following CLSI Quality Control of Microbiology Transport System: Approved Standard - Second Edition. Each tube contains glass beads to facilitate cell lysis, sample homogeneousness and maximize the elution of the sample from the swab. Designed for cell cultivation and compatible with molecular diagnostic techniques by quantitative PCR.

Peel-pack package.
Swab sterilised by radiation.



mod.	code	ml	description	label colour	breakpoint mm	case quantity	case weight	case volume
B 1	304271*	1	with standard flocced swab	●	80	6 x 60	4.7	0.056
B 1	304278*	2	with standard flocced swab	●	80	6 x 60	5.1	0.056
B 2	304276*	2	with urethral flocced swab	●	80	6 x 60	5.0	0.056
B 3	304270*	2	with nasopharyngeal flocced swab	●	100	6 x 60	5.0	0.056
B 4	304279*	2	with minitip flocced swab	●	100	6 x 60	5.0	0.056
A 1	304273*	3	with standard flocced swab	●	100	6 x 40	4.8	0.056
 A 1	304273.2S*	3	with 2 swabs (nasopharyngeal and standard)	●	100	6 x 40	5.09	0.056

*Code not available for sale in Italy, UK and Ireland. Shelf life: 24 months.

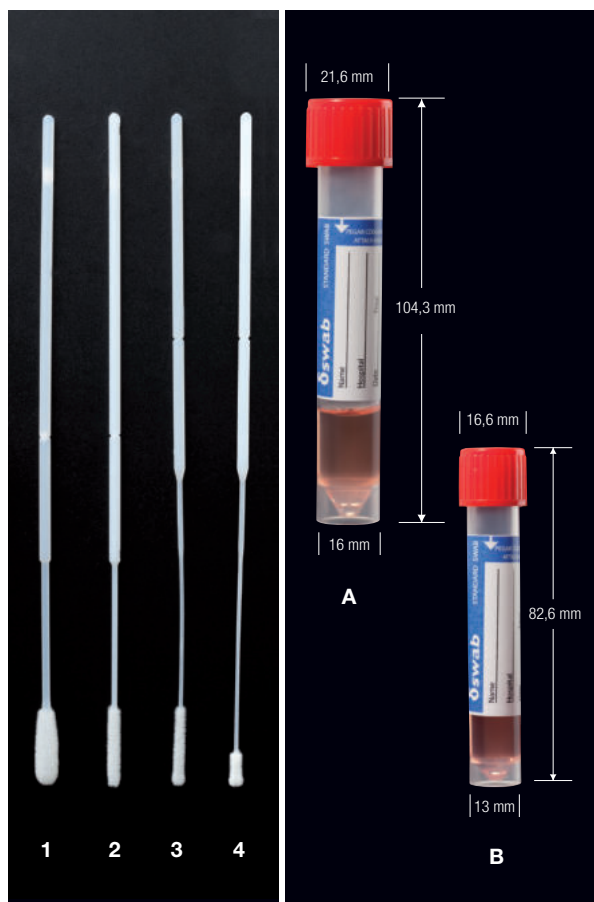

Virus

Particularly suited for collecting and transporting microbiological samples which contain viruses. By including antibiotics which inhibit the growth of Bacteria and Fungi, it ensures the trustworthiness of the sample. It maintains the infectability of viruses for up to 96 hours, both at room temperature (20-25°C) and at refrigeration temperature (4-8°C), following CLSI Quality Control of Microbiology Transport System: Approved Standard - Second Edition. Designed for cell cultivation and to be compatible with the molecular diagnostic techniques by quantitative PCR.

Peel-pack package.
Sterilised by radiation.



mod.	code	ml	description	label colour	breakpoint mm	case quantity	case weight	case volume
B 1	304291*	1	with standard flocced swab	●	80	6 x 100	5.7	0.056
B 3	304297*	1	with nasopharyngeal flocced swab	●	100	6 x 100	5.5	0.056
A 3	304295*	3	with nasopharyngeal flocced swab	●	100	6 x 80	7.0	0.056

*Code not available for sale in Italy, UK and Ireland. Shelf life: 18 months.

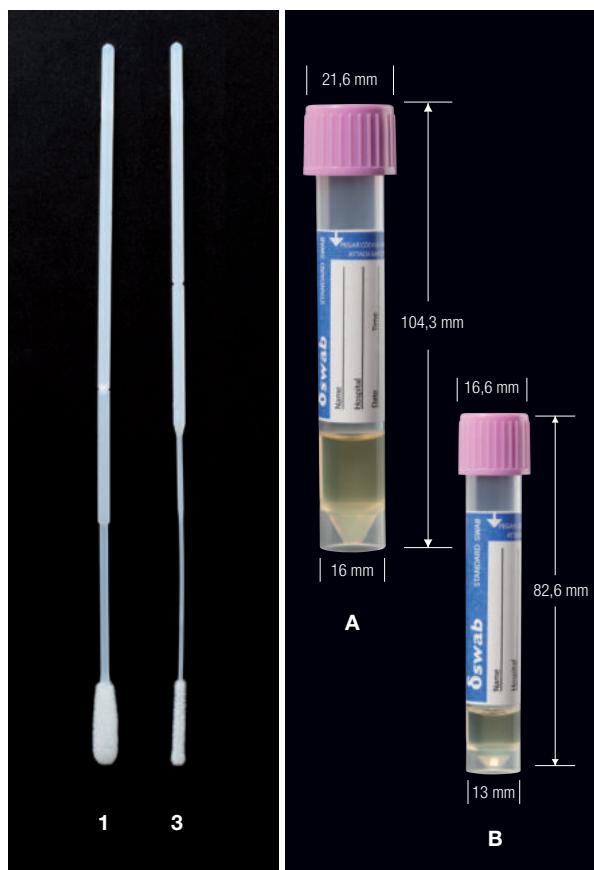

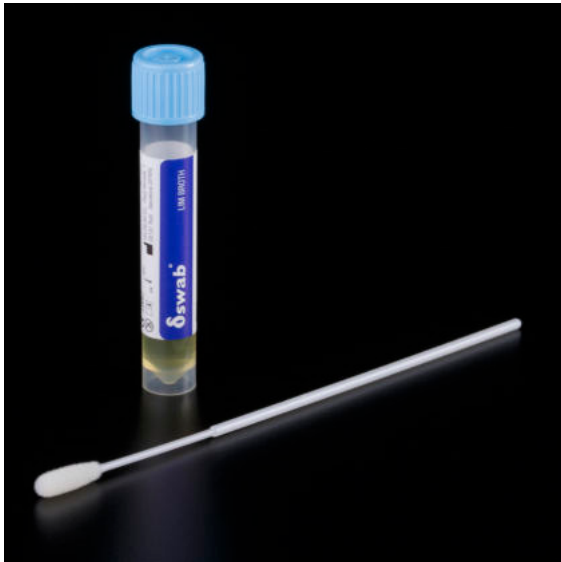

LIM Broth

Selective enrichment medium for Group B Streptococcus, including *S. agalactiae*. The kit consists of a tube with conical bottom, skirted and screw cap, containing 2 ml LIM broth, and a standard flocked swab.

Packed in peel pack (plastic peel pack) with the basic information and instructions printed.

Swab sterilised by radiation.



code	description	tube height mm	cap Ø mm	case quantity	case weight	case volume
304212*	2 ml LIM	82.6	16.6	6 x 60	4.00	0.056

*Code not available for sale in Italy, UK and Ireland. Shelf life: 16 months.

ENRICHMENT MEDIA



Selenite

Enrichment medium that inhibits the proliferation of bacterial microbiote.

It is particularly suited for isolating *Salmonella* from faecal samples, food and/or water. It is used as an enrichment medium for clinical and industrial samples. Easy and practical.

Compatible with manual and automated systems of microbiological culture and suitable for molecular assays.



code	description	tube height mm	cap Ø mm	case quantity	case weight	case volume
304210	2 ml Selenite	82.6	16.6	6 x 60	2.84	0.025

Shelf life: 24 months



Thioglycolat

Widely used enrichment media for isolation and cultivation of Aerobic and Anaerobic Bacteria and Fastidious Bacteria.

It is used as an enrichment media for clinical samples.

Easy and practical. Compatible with manual and automated systems of microbiological culture and suitable for molecular assays.



code	description	tube height mm	cap Ø mm	case quantity	case weight	case volume
304211	2 ml Thioglycolat	82.6	16.6	6 x 60	2.84	0.025

Shelf life: 12 months

CRYOINSTANT: Cryoplates for the conservation of microbiological strains

Sterile system for the conservation of microbiological strains (for example, fungi in sporulation phase), consisting of a 2 ml cryovial with a skirt, containing 25 glass cryoprobes treated with cryoprotectants that act as a preservative.

Thanks to this system we can:

- Have a **perfect means of conservation**
- Obtain up to **25 replicas** of the same microbial generation to use progressively for years
- Facilitate the inoculation of the bacteriological medium, since each pearl is equivalent to a culture
- Dispense with the defrosting of the entire vial every time we extract a pearl
- Avoid the formation of ice crystals in recovery
- **Minimize the risk of cross contamination**
- **Save freezer space**

COMPONENTS

The cryovial made of polypropylene is external thread. Resists up to **-190 °C**. Long skirt cap, with silicone gasket To facilitate the classification of samples, our cryovials are offered with caps and pearls in five different colors (except code 409113/6, which is an assortment).

This system allows rapid identification of the sample, differentiating each type of microorganism according to the color of the cap and the pearl. The cryovials are presented in a rack of 100 units, made of cardboard resistant to **-100 °C**. Each box is supplied labeled with indication of code, batch, expiration, cap color, and shrink wrap.

Rack dimensions: 150 x 150 x 55mm. (More information about these boxes on page 214. See code M-600).

Expiration: 48 months from the date of manufacture. **Sterile by autoclave.**

HOW TO USE

1. Take the strain sample using a handle (see our handles on page 34 and 35)
2. Inoculate the vial by inserting the handle into the preservative medium
3. Close the vial and shake it gently so that the strain is impregnated in the cryoplates
4. Extract the remaining preservative medium using a Pasteur pipette (see our Pasteur pipettes between pages 198-203)
5. Close the cryovial and freeze
6. Every time we want to reproduce the strain, we will extract one of the cryoplates with a handle or a clamp
7. We will place the cryoperle on a plate with medium, ensuring that the entire surface of the pearl enters in contact with the medium

code	cap and pearls colour	case quantity	case weight	case volume
409113/1	○	100	0.59	0.002
409113/2	●	100	0.59	0.002
409113/3	●	100	0.59	0.002
409113/4	●	100	0.59	0.002
409113/5	●	100	0.59	0.002
409113/6	assorted: 5 colours x 20 cryovials	100	0.59	0.002

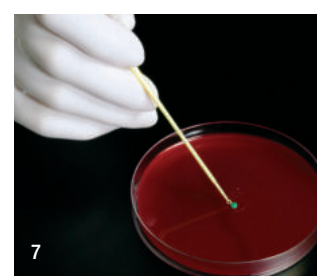
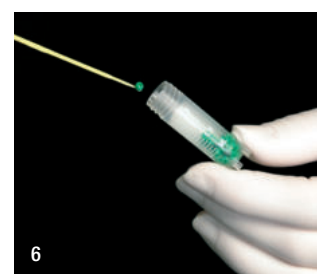
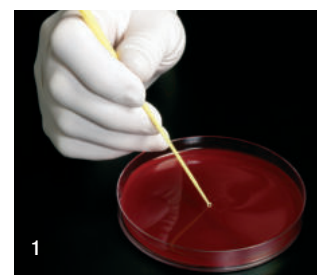

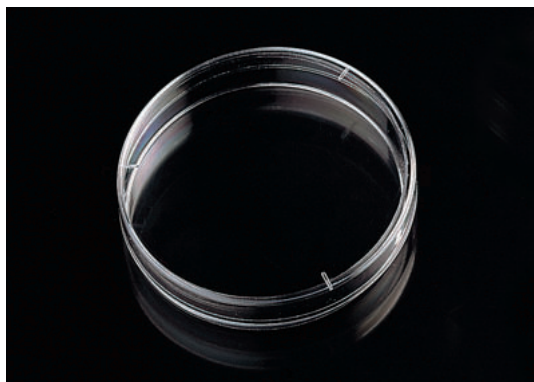

90 x 14 mm Petri Dish

Made in polystyrene. Supplied in groups of 20 units, packaged in heat sealed bags. Code 200200 is **aseptic**. Code 200209 is **sterile by radiation**. Suitable for automatic filling machines.

code	description	sterile	aseptic	case quantity	case weight	case volume	cases per pallet
With three vents							
200200	Ø 90 x 14 mm	no	✓	25 x 20	7.32	0.071	28
200209	Ø 90 x 14 mm	STERILE R	✓	25 x 20	7.39	0.071	28
Not vented dishes, for the cultivation of anaerobic							
200200.4	Ø 90 x 14 mm	non	✓	25 x 20	6.90	0.071	28



90 x 14 mm Petri Dish, two compartments

Made in polystyrene. **Aseptic**. With three vents. Supplied in groups of 20 units, packaged in heat sealed bags. Suitable for automatic filling machines.

code	description	aseptic	case quantity	case weight	case volume	cases per pallet
200202	Ø 90 x 14 mm 2 compartments	✓	25 x 20	7.75	0.072	28



90 x 14 mm Petri Dish, three compartments

Made in polystyrene. **Aseptic**. With three vents. Supplied in groups of 20 units, packaged in heat sealed bags. Suitable for automatic filling machines.

code	description	aseptic	case quantity	case weight	case volume	cases per pallet
200203	Ø 90 x 14 mm 3 compartments	✓	25 x 20	7.82	0.070	28

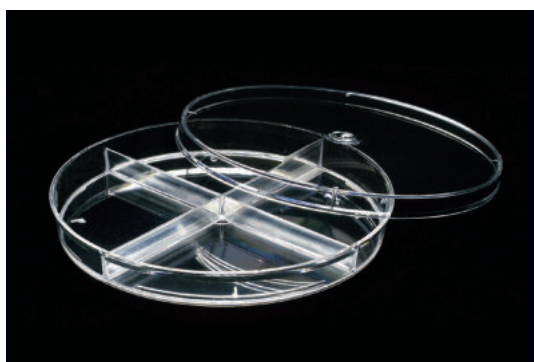

90 x 15 mm Petri Dish, four compartments

Made in polystyrene. **Aseptic**. Vented. Supplied in groups of 24 units, packaged in heat sealed bags. Suitable for automatic filling machines.

code	description	aseptic	case quantity	case weight	case volume	cases per pallet
200210	Ø 90 x 15 mm 4 compartments	✓	24 x 25	9.20	0.077	28

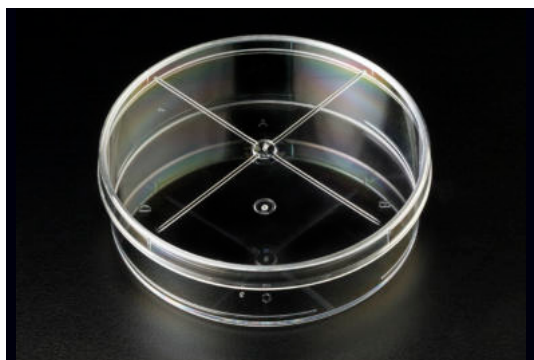

90 x 25 mm Petri Dish

Made in polystyrene. **Aseptic**. Vented. Supplied in groups of 24 units, packaged in heat sealed bags. Suitable for automatic filling machines.

code	description	aseptic	case quantity	case weight	case volume	cases per pallet
200215	Ø 90 x 25 mm	✓	24 x 13	8.63	0.076	24

90 x 15.8 mm Petri Dish

Made of high transparency polystyrene.

Aseptic.

Suitable for the general growth of all types of organisms or microorganisms aerobic and / or anaerobic.

Flat surface. Easily stackable thanks to the outer flange of the lid.



code	description	aseptic	case quantity	case weight	case volume	cases per pallet
200200H	Ø 90 x 15,8 mm	✓	25 x 20	7,50	0,036	20

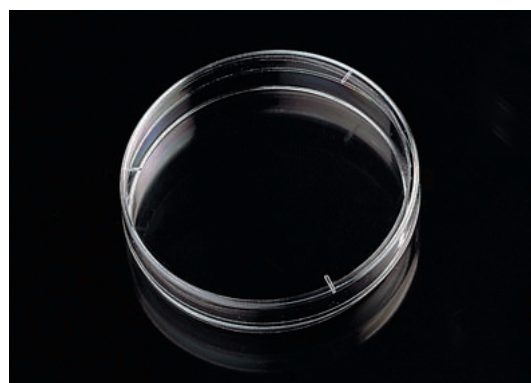

Petri Dish 90 x 15 mm with internal cross

Made in polystyrene. **Aseptic.**

With four vents. Stackable.

With a mark on a side that helps orientation and a writing area on the bottom.

Supplied in groups of 25 units, packaged in heat sealed bags.

Suitable for automatic filling machines.

Internal cross guarantees the totally flat base.

code	description	aseptic	case quantity	case weight	case volume	cases per pallet
200200.5	Ø 90 x 15 mm internal cross	✓	24 x 25	7.50	0.076	20

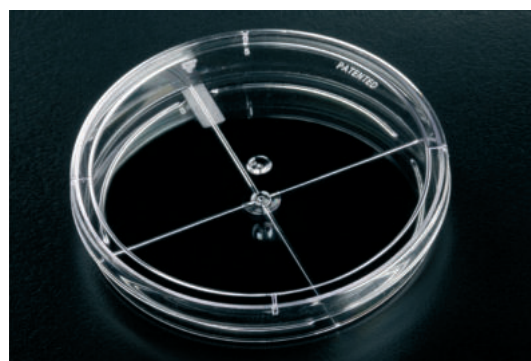

140 x 20 mm Petri Dish

Made in polystyrene. With three vents.

Suitable for automatic filling machines.

Code **200214** is **aseptic**.

Code **200219** is **sterile by radiation**.

code	description	sterile	aseptic	case quantity	case weight	case volume	cases per pallet
200214	Ø 140 x 20 mm	no	✓	11 x 15	7.40	0.074	30
200219	Ø 140 x 20 mm	STERILE R		11 x 15	7.25	0.072	30

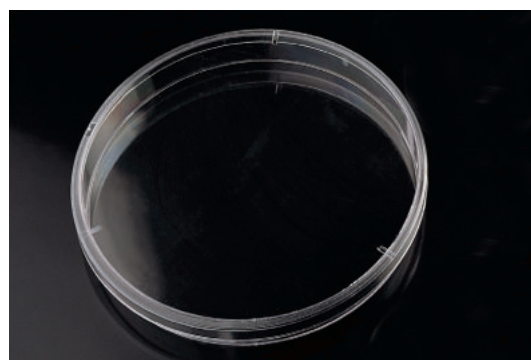

120 x 120 mm squared Petri Dish

Made in polystyrene.

Aseptic.

With four vents.

Supplied in groups of 10 units, packaged in heat sealed bags.

Suitable for automatic filling machines.

code	description	aseptic	case quantity	case weight	case volume	cases per pallet
200204	120 x 120 mm	✓	24 x 10	11.18	0.072	28



55 x 14 mm Petri Dish

Made in polystyrene. With four vents.

Supplied in groups of 15 units, packaged in heat sealed bags.

Suitable for automatic filling machines.

Code **200201** is **aseptic**.

Code **200201.B** is **sterile by radiation**.

code	description	sterile	aseptic	case quantity	case weight	case volume	cases per pallet
200201	Ø 55 x 14 mm	no	✓	80 x 15	8.40	0.068	30
200201.B	Ø 55 x 14 mm	STERILE R		80 x 15	8.46	0.068	30



Ø 100 mm Petri dish baskets

These stainless steel baskets are suitable for dishes of diameter up to 10 cm.

Two models available to hold 16 or 32 Petri dishes.

We can supply customer-designed models.

code	description	L x W x H mm (height without handle)	case quantity	case weight	case volume
H-600	1 section, holds up to 16 dishes	105x110x250	1	0.13	0.005
H-601	2 sections, holds up to 32 dishes	105x215x250	1	0.31	0.009

Height with handle: 360 mm.



Jar for anaerobes incubation

Incubation system for petri dishes in practical and simple anaerobiosis.

Jar of polycarbonate designed for use with any of anaerobiosis that generate special atmospheres.

Up to 14 90mm diameter petri plates.

Metal cap fixed by locking pressure system.

Stainless steel rack.

Viton® O-ring.

Compatible with all the usual reagents in microbiology.

code	dimensions* (mm)	case quantity	case weight	case volume
H-625	119,4x285	1	1.17	0.0072

*Diameter x height.



Contact plates

Aseptic production.

Used in the pharmaceutical industry, hospital environments for determining bacterial contamination of surfaces such as the skin, operating tables, refrigerated gondolas, and work surfaces.

They are manufactured in transparent polystyrene.

The moulded grid at the bottom makes it possible to identify the detected contamination per cm² and it facilitates the counting of colonies.

Stable stacking: The shape of the lid makes stacking perfectly stable during transport and incubation, and saves space on work surfaces.

Dimensions of the dish: 65,7 mm x 14,7 mm height.

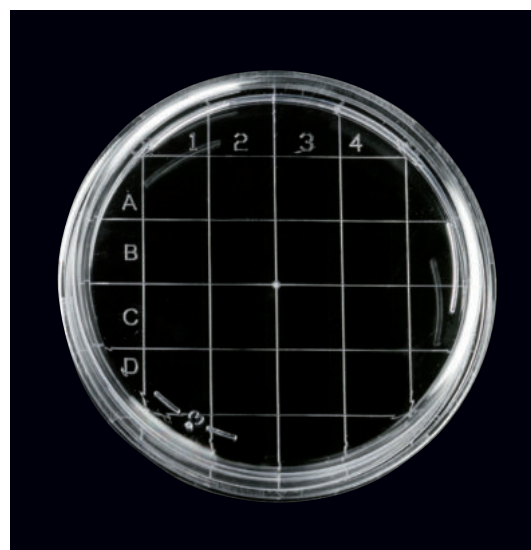
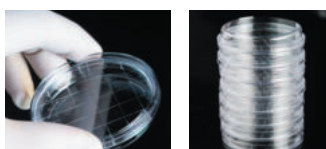

code	description	sterile	case quantity	case weight	case volume	cases per pallet
200208	Rodac contact plate	no	25 x 20	5.00	0.031	70
200218	Rodac contact plate	STERILE R	25 x 20	4.90	0.030	70



Moulded contact plate rack

Useful for safe transport and incubation of Rodac contact plates and helpful to streamline bench top sample processing. Each rack holds up to 60 contact plates with lids (minimum diameter: 65 mm, maximum diameter: 72 mm) configured in six columns of ten plates. Up to 4 racks can be stacked together, and all interlock to prevent accidental knock over.

Access slots under each stack of contact plates allows a stack of plates to be safely removed from the rack using a secure ring that places a finger under the bottom plate and thumb on top of the lid if the top plate.

A large centre divider provides space for labelling and incorporates a handle.

All parts are moulded with white polypropylene and are steam **autoclavable at 121 °C**. Racks are supplied individually bagged, flat, and can be easily assembled (instructions included).

code	dimensions* (mm)	case quantity	case weight	case volume
H-610	266 x 165 x 178	1	0.39	0.002

*Lenght x width x height.



Moulded 90 or 100 mm Petri dish rack

Useful for safe transport and incubation 90 or 100 mm Petri dishes and helpful to streamline bench top sample processing.

Each rack holds up to forty-two Petri dishes with lids, configured in six columns of seven plates. Up to 4 racks can be stacked together, and all interlock to prevent accidental knock over. Access slots under the bottom Petri dishes allows a stack of dishes to be safely removed from the rack using a secure ring that places a finger under the bottom dish and thumb on top of the lid if the top dish.

A large centre divider provides space for labelling and incorporates a handle.

All parts are moulded with white polypropylene and are steam **autoclavable at 121 °C**.

Racks are supplied individually bagged, flat, and can be easily assembled (instructions included).

code	dimensions* (mm)	case quantity	case weight	case volume
H-611	330 x 210 x 178	1	0.40	0.005

*Lenght x width x height.





Stackable Petri dish incubation tray

This polypropylene tray increases overall capacity of incubator. Designed to hold five 100 mm diameter or fifteen 60 mm diameter Petri dishes, it's provided with two large label areas for critical sample identification by marker or label.

With 16 vents.

Not autoclavable.



code	dimensions (mm)	case quantity	case weight	case volume
H-615	251 x 35 x 237	3	0.82	0.011



Microtitre plates, sterile

Made of high transparency polystyrene.

Standard 96-well plates.

Three models available depending on the bottom of the well.

- **Flat bottom plates ("LI" shaped plate)** are more suitable for optical reading (for example, by means of a spectrophotometer). They are also suitable for cell culture in suspension, as well as for those ELISA applications in which the treatment of the surface is not required to improve the adhesion between the plate and the antigen or antibody.
- The **tapered bottom plates ("V" shaped plate)** is very practical when you need to recover the entire sample or to separate components by centrifugation. They can be used for the complement fixation technique
- **Round bottom plates ("U" shaped plate)** are also used to recover the entire sample or to separate components by centrifugation.

Other applications:

- Dilution
- Preparation of serial samples
- Protein precipitation
- Hemagglutination

The cover, in transparent polystyrene, is supplied separately (codes **900015** or **900015.1**).

These plates can also be covered using the transparent sealing film or the plate sealing mat (see page 76).

Both sterile and non-sterile models are supplied in an individual bag.

Dimensions of the plate: 127.7 x 85.8 mm.

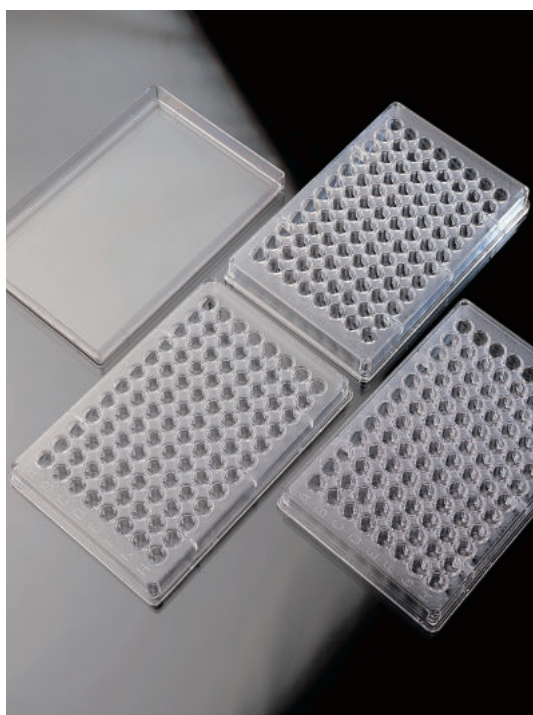

code	description	sterile	well plate estimate volume	case quantity	case weight	case volume
900010	microtitre plate "U" form	STERILE R	281 µl	50	2.15	0.013
900010.1	microtitre plate "U" form	no	281 µl	50	2.50	0.013
900011	microtitre plate "L" form	STERILE R	404 µl	50	2.33	0.013
900011.1	microtitre plate "L" form	no	404 µl	50	2.33	0.013
900012	microtitre plate "V" form	STERILE R	219 µl	50	2.33	0.013
900012.1	microtitre plate "V" form	no	219 µl	50	2.33	0.013
900015	lid for microtitre plate	STERILE R	-	50	1.28	0.016
900015.1	lid for microtitre plate	no	-	50	1.16	0.013

Digralsky spreader. Sterile

Designed for surface spreading. Made of white polystyrene. **Sterilized by ethylene oxide.** Total length: 149 mm, base length: 40 mm. Base length allows spreading liquid samples over any type of Petri dish and avoids contact with the dish walls. The curved Spreader extremity and rounded corners avoid damaging media surface while spreading. The tip bent and rounded edges minimize the possibility of breakage of the solid medium during extension. It allows their use in places where sterilization before use is not possible (for instance when samples are collected far from the lab). Available in peel-pack containing 1 or 5 units, marked with code, expiry date, lot and sterilization method.



code	presentation	case quantity	case weight	case volume
200500.1	5 units peel-pack	1,000	3.32	0.018
200510.1	1 unit peel-pack	1,000	3.6	0.079



Nichrome wire loops

Nichrome wire loops for microbiology. Comparing them to the traditional loops made of platinum and rhodium, the nickel and chrome alloy results much more competitive in terms of durability and price. Moreover, it offers a totally smooth surface, and rapid cooling after heat sterilisation.

Non-calibrated loops (mod. A and B):

Non-calibrated nichrome loops, without holder, saving money and storage space. Supplied in groups of 25 units, in one tube, specifying code, description, and lot.

Calibrated loops (mod. C and D):

Calibrated nichrome loops. Supplied individually in a capped tube, labeled with the code, description and lot.

Calibrated and non-calibrated loops are easily joinable to the PVC and aluminium holder (mod. E) with an easy and fast screw movement.

Dimensions of the aluminium holder 150 mm.

Non-calibrated loops with holder (mod. F and G):

Non-calibrated loop made of nichrome alloy.

Light aluminium holder (mod. G, golden colour, mod. F, green) partially protected by a transparent, insulating, non-skid plastic. Dimensions, 275 mm.

mod.	code	description	dimensions mm	case quantity	case weight	case volume
A	302762	Non-calibrated loop 2 mm Ø	75	25	0.025	0.000001
B	302764	Non-calibrated loop 4 mm Ø	75	25	0.30	0.0001
C	302771	Calibrated loop 1 µl	80	1	0.01	0.00004
D	302772	Calibrated loop 10 µl	80	1	0.008	0.00004
E	302780	Loop holder, PVC and aluminium	150	1	0.02	0.00001
F	302792	Non-calibrated loop (2 mm Ø) with holder	275	5	0.059	0.002
G	302794	Non-calibrated loop (4 mm Ø) with holder	275	5	0.057	0.002

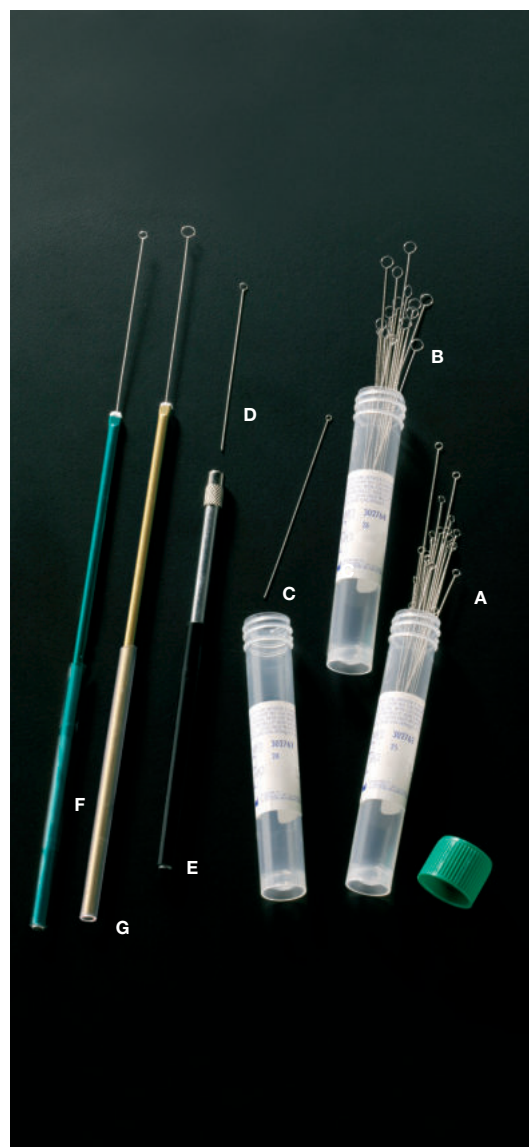

Streaking needles

Sterile polypropylene planting needle. Flexible, red. **Product sterilized by radiation.**

code	description	case quantity	case weight	case volume
668811	10 units peel-pack	6 x 1,000	7.78	0.030

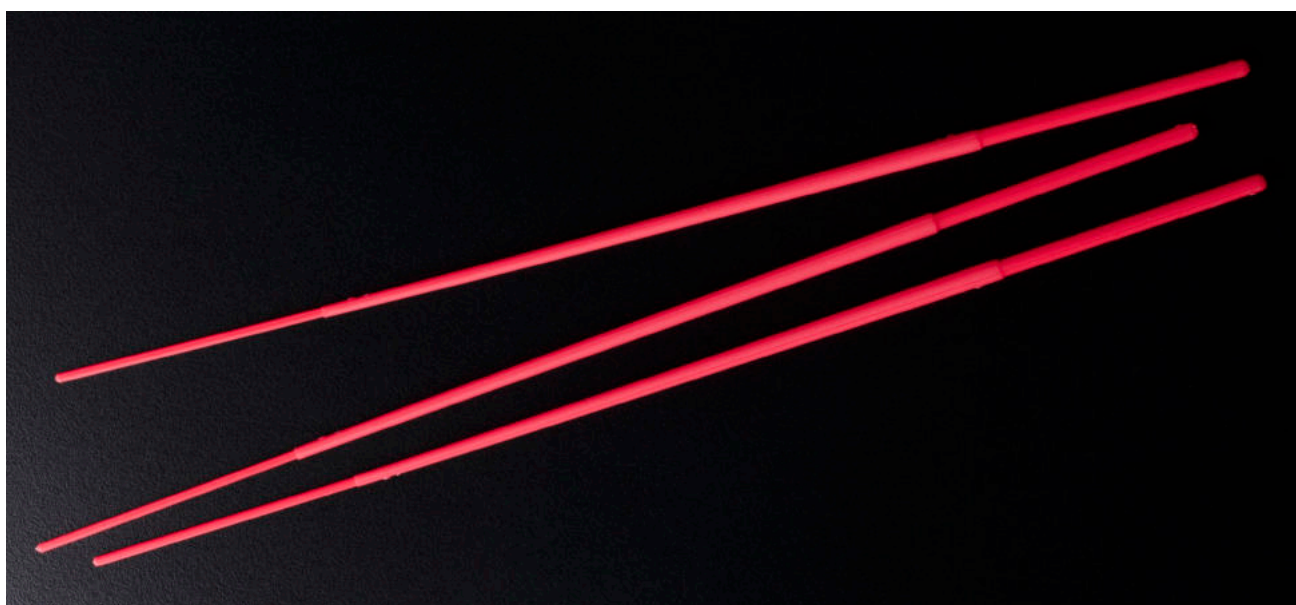

Sterile calibrated loops

Inoculation loops used for collection and inoculation by streaking or puncturing method. Flexible loops made of HIPS material. Hexagonal shaft with stripes. They are ideal for inoculation in gel surface by streaking.

Sterilised by radiation.

Two sizes available: 1 µl and 10 µl.

Not recommended for colony counting. Sterile inoculating loops.

Batch and expiry date printed on the bag.

The packaging offers a double closure with a zipper system that closes the coat once opened.

Internal diameter 1 µl handle: 0.75 ± 0.08 mm

Internal diameter 10 µl handle: 4.1 ± 0.08 mm



code	µl	presentation	colour	case quantity	case weight	case volume
302713	1	10 ud. zip lock	green	10 x 1,000	14.21	0.072
302733	1	20 ud. zip lock	green	10 x 1,000	12.75	0.072
302714	10	10 ud. zip lock	blue	10 x 1,000	14.3	0.072
302734	10	20 ud. zip lock	blue	10 x 1,000	12.8	0.070

Sterile calibrated loops

Loops made of polystyrene, high robustness and adequate flexibility for comfortable and efficient use. **Sterilised by radiation.**

Double use loops: at one of the ends there is the loop for streaking in Petri dishes, using both qualitative and quantitative techniques. At the other end there is a fine tip specially designed for counting colonies. Available in 2 volumes: 1 and 10 µl. The green and blue colors are used to easily differentiate the 2 volumes in the laboratory. They offer great ergonomics and gripping thanks to its hexagonal design of its section which provide ease of orientation while using it. There are 3 presentations: individual pack, 10 and 20 units. All of them are supplied in a plastic packaging with easy opening.

The loops are calibrated. **Deltalab** certifies the control of the dimensional accuracy of the diameter of the loop by means of specific gauge (**Calibration certificate available under request**).

Internal diameter 1 µl handle: 1.42 ± 0.05 mm

Internal diameter 10 µl handle: 3.98 ± 0.05 mm

code	µl	presentation	colour	case quantity	case weight	case volume
302743	1	individual flow pack	green	2 x 600	1.90	0.029
302744	1	peelable flow pack 10 units	green	2 x 1,400	2.95	0.029
302745	1	peelable flow pack 20 units	green	2 x 2,500	4.31	0.029
302753	10	individual flow pack	blue	2 x 600	1.90	0.029
302754	10	peelable flow pack 10 units	blue	2 x 1,400	3.00	0.029
302755	10	peelable flow pack 20 units	blue	2 x 2,500	4.34	0.029



EUROTUBO® 12 ml screw cap tubes, round bottom

Made of **autoclavable (121 °C)** transparent polypropylene or polystyrene. Green cap made of high density polyethylene.

Dimensions: 15 x 102 mm. The external skirt allows the tubes to remain **free-standing**. Supplied screwed. Recommended volume: 12 ml. The sterile model (ethylene oxide) is supplied individually in flow-pack bag, with indication of batch, expiration date, etc.

According to the guidelines for sterile products. Resistance to centrifugation: **PS: 7,500 xg. PP: 15,000 xg.**

Attention: For autoclaving, the cap should be loose on the thread and not tightly fitted.

mod.	code	sterile	description	autoclavable	maximum volume ml	recommended volume ml	case quantity	case weight	case volume	cases pallet
1	301403	no	polystyrene		14.4	12	6 x 250	12.90	0.082	20
2	301402	STERILE EO	polystyrene individually wrapped		14.4	12	6 x 250	13.40	0.096	16
3	401402	STERILE EO	polypropylene individually wrapped	✓	14.2	12	6 x 250	12.03	0.096	16
4	401403	no	high transparency polypropylene	✓	14.2	12	6 x 250	11.11	0.082	20

Dimensions (±0,09) :

code	external cap Ø mm A	external tube Ø mm B	internal tube Ø mm C	length with cap mm D	length without cap mm E
301402, 301403	20.9	16.3	14.4	103.9	102.5
401402, 401403	20.9	16.2	14.3	102.9	101.5

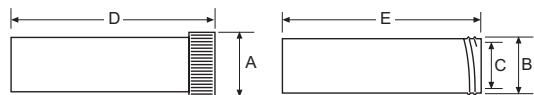

Sterile culture tubes in polystyrene

Tubes supplied with either a two position ribbed polyethylene cap, which can be left loose for aerobic work or sealed for anaerobic cultures.

They are biologically inert, exempt from mold release agents, and withstand up to **1,400 xg** and **70 °C**.

Packaged in self-standing resealable zip-lock bags of 125 units.



Loose position for aerobic work



PosSealed position for anaerobic cultures

code	dimensions mm	volume	case quantity	case weight	case volume
300807	12 x 75	5ml	8 x 125	4.24	0.033
300808	17 x 100	14ml	8 x 125	7.14	0.060

15 ml and 50 ml centrifugal tubes

Made of polypropylene, suitable for both clinical and research applications.

DNAsa, RNAsa and pyrogen free. They are also free from natural rubber and heavy metals.

High transparency of the material for a clear visualization during experiments specially for molecular biology and animal tissue culture.

Tube and cap designed with the system of flat threads for a complete leakproof.

Highly smooth hydrophobic surface for minimum disturbance during centrifugation.

Silk-screen blue graduation in the tube and large white frosted portion for easy writing.

Autoclavable at 121 °C.

Centrifugation resistance: **14.000 xg**, except code **429931: 7.500 xg** and codes **429950, 429951: 3.500 xg**

It is recommended to use adapters to centrifuge and avoid malformations.

Available models: 15 ml non-skirted and 50 ml skirted and non-skirted.

code	description	presentation	sterile	case weight	case volume	cases pallet
15 ml tubes						
429940	non-skirted tube	500 tubes in bulk	no	500	4.50	0.034
429945	non-skirted tube	20 bag to 25 tubes.	no	500	4.50	0.0281
429942	non-skirted tube	20 bag to 25 tubes.	STERILE R	500	4.35	0.04
50 ml tubes						
429930	non-skirted tube	20 bag to 25 tubes.	no	500	7.70	0.09
429931	non-skirted tube	20 bag to 25 tubes.	STERILE R	500	7.44	0.108
429950	skirted tube	20 bag to 25 tubes.	no	500	8.80	0.09
429951	skirted tube	20 bag to 25 tubes.	STERILE R	500	8.80	0.108



EUROTUBO® 15 ml conical tubes

Tubes made of transparent polypropylene, conical bottom, suitable for centrifugation tests in immunology, microbiology, etc.
 Continuous thread, external moulded graduations in 0,5 ml increments.
 Wrinkled area (55 x 10 mm).

Blue cap in polyethylene with hermetical closure thanks to its internal elastic obturation.

Code **429910** is autoclavable (**121°C**) with the cap not being closed, just placed on the thread.

Autoclave not recommended for the codes **429920** and **429946**, as they have been **sterilised by radiation**.

Code **429920** is supplied sterile (100 units bags).

The bag specifies IVD, lot number, expiration date, etc.

Code **429946** is supplied sterile in individual bags. Resistance to centrifugation: **7,000 xg** (non sterile model) and **5,000 xg** (sterile models).

It is recommended to use adapters to centrifuge and avoid malformations.

Length (with cap): 120 mm. External mouth diameter: 17 mm. External cap diameter: 20,9 mm.

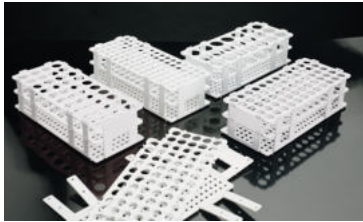

POLYPROPYLENE RACKS
Pag. 224

code	sterile	autoclavable	case quantity	case weight	case volume	cases pallet
429910	no	✓	500	3.94	0.030	54
429920	STERILE R		5 x 100	3.90	0.029	54
429946	STERILE R individually bagged		500	3.96	0.040	40



Please find racks for these tubes in chapté **Sample Storage**



EUROTUBO® 50 ml conical tubes

Tubes made of transparent polypropylene, conical bottom, suitable for centrifugation tests in immunology, microbiology, etc.

Perfect to analyse Koch bacillus. Continuous thread, external moulded graduations in 5 ml increments.

Blue cap in high density polyethylene with hermetical closure thanks to its internal elastic obturation.

Skirted and non skirted versions, **sterilised by radiation** and non sterilised versions. Sterile codes are either supplied in individual bags (codes **429926**, **429927**), in bags of 100 units (codes **429926.10**, **429927.10**), or in bags of 25 units (codes **429926.25**, **429927.25**) and resist up to **7,000 xg**.

Autoclave not recommended as they have been ionised.

Non sterile codes withstand up to **12,000 xg** and are autoclavable (**121 °C**) with the cap loose on the thread and not tightly fitted.

Every version is supplied capped, excepting code **429900SP**, which is supplied uncapped, with the cap in a separated bag.

You need to use the proper adapters to the tube of the code **429926** during the centrifugación to avoid malformations.

POLYPROPYLENE RACKS:

- W-018
- 19568
- 19570



METAL RACKS:

- R-292 • R-293
- R-281 • R-282
- R-283



code	sterile	description	external cap Ø mm	internal tube Ø mm	external tube Ø mm	length with cap mm	case quantity	case weight	case volume	cases pallet
429900	no	non skirted	34.4	27.2	29.5	117.5	500	7.80	0.072	20
429900SP	no	non skirted, unscrewed cap	34.4	27.2	29.5	117.5	500	7.90	0.082	20
429901	no	skirted	34.4	27.2	29.5	117.5	500	8.50	0.082	20
429926	STERILE R	non skirted, individually wrapped	34.4	27.2	29.5	117.5	500	8.00	0.080	20
429926.25	STERILE R	non skirted, bag 25 units	34.4	27.2	29.5	117.5	20x25	8.30	0.082	20
429926.10	STERILE R	non skirted, bag 100 units	34.4	27.2	29.5	117.5	5x100	7.90	0.082	20
429927	STERILE R	skirted, individually wrapped	34.4	27.2	29.5	117.5	500	8.80	0.082	20
429927.25	STERILE R	skirted, bag 25 units	34.4	27.2	29.5	117.5	20x25	8.80	0.082	20
429927.10	STERILE R	skirted, bag 100 units	34.4	27.2	29.5	117.5	5x100	8.50	0.082	20



Please find racks for these tubes in chapter **Sample Storage**



15 ml and 50 ml conical high resistance tubes. Sterile

Tubes made of transparent, copolymer polypropylene.

Green caps made of polyethylene with an internal liner which ensures leakproofness.

Tubes feature a solvent resistant white panel and black graduations for use both for clear or dark samples.

DNase, RNase, endotoxins and metal free.

They are **sterile by radiation** and withstand temperatures down to **-90 °C** (15 ml) and **-80 °C** (50 ml)..

Resistance to centrifugation: **17,000 xg** (15 ml) and **20.000 xg** (50 ml).

Autoclavable tube (the liner of the cap is not autoclavable)

Supplied in bags of 50 units.

Bags are printed with instructions for use and feature a double closure: a first tamper evident seal that helps guaranteeing sterility, and a secondary zip-lock, resealable closure.

	code	presentation	capacity ml	dimensions mm	case quantity	case weight	case volume
1	409920	bag 50 units	15	17 x 118	10 x 50	3.90	0.035
2	409922	bag 50 units	50	29.6 x 114.6	10 x 50	8.07	0.076

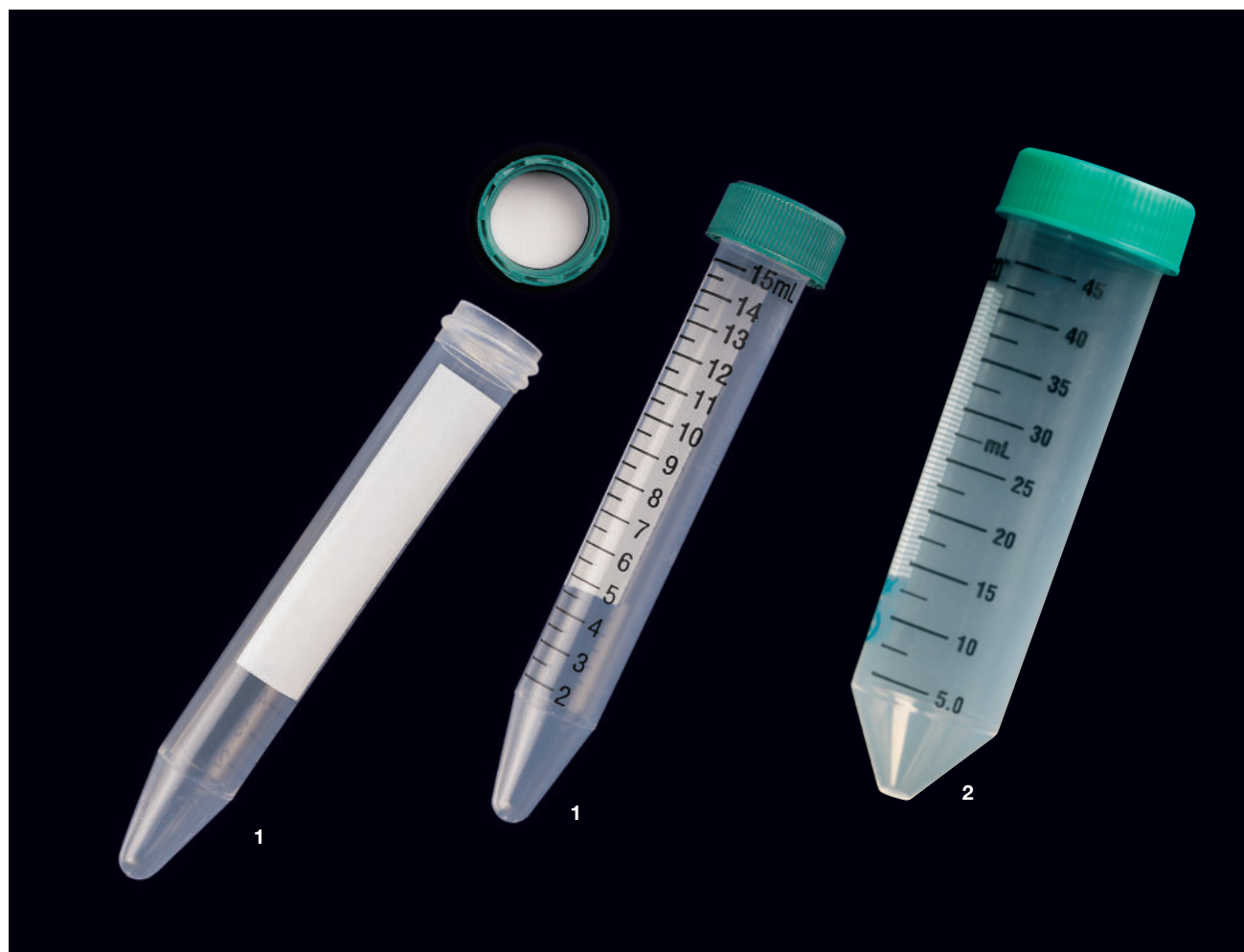

Sterile serological pipettes

Made of glass polystyrene. Single use only.

Serological pipettes have an accuracy of +/- 2% at full scale.

Sterilized by radiation.

Manufactured in one, two or three pieces depending on the volume.

They guarantee maximum precision without liquid retention at the welding level and offer a total dispensing. Pyrogenic, non-cytotoxic and non-hemolytic. Volumes from 1 ml to 50 ml, identified with a polyolefin (does not contain synthetic fibers) white cotton and screen printed in color according to volume. The peel-pack of the models presented in this way is fiber-free and easy to open. Black graduations, bright and unalterable. Negative scale and double inverted scale (ascending and descending graduations).

DNase and RNase free.

Manufactured in a room with controlled environment, class 100,000.

BSE / TSE free.

This product does not contain latex.

Three models of tips available:

A = TAPE END,

B = WIDE TIP,

C = OPEN TIP

(recommended for viscose samples).

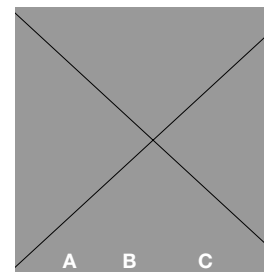

code	capacity ml	presentation	cotton colour	tip	graduation ml	negative graduation ml	total capacity ml	case quantity	case weight	case volume
900030.C	1	1 peel-pack	●	A	0/0.9	until -0.3	1.3	500	2.59	0.019
900031.C	1	bag of 25	●	A	0/0.9	until -0.3	1.3	40 x 25	4.02	0.019
900130.C	1	1 peel-pack	●	C	0/0.9	until -0.3	1.3	500	2.59	0.019
900032.C	2	1 peel-pack	●	A	0/1.8	until -0.6	2.6	500	3.74	0.019
900033.C	2	bag of 25	●	A	0/1.8	until -0.6	2.6	40 x 25	6.70	0.019
900034.C	5	1 peel-pack	●	A	0/4	until -3	8	200	2.42	0.014
900038.C	5	bag of 25	●	A	0/4	until -3	8	20 x 25	6.38	0.019
900144.C	5	1 peel-pack	●	B	0/4	until -3	8	200	2.42	0.014
900036.C	10	1 peel-pack	●	A	0/9	until -3	13	200	2.73	0.014
900037.C	10	bag of 25	●	A	0/9	until -3	13	16 x 25	5.5	0.019
900136.C	10	1 peel-pack	●	C	0/9	until -3	13	200	2.32	0.013
900146.C	10	1 peel-pack	●	B	0/9	until -3	13	200	3.82	0.014
900041.C	25	1 peel-pack	●	A	0/23	until -8	33	150	3.07	0.019
900043.C	50	1 peel-pack	●	A	0/46	until -10	60	100	2.54	0.019

Find trays, rotary stands and other products for pipettes in chapter **Safety and General Labware**



See our plastic Pasteur pipettes in chapter **Liquid Handling**



Please find racks for these tubes in chapter **Sample Storage**

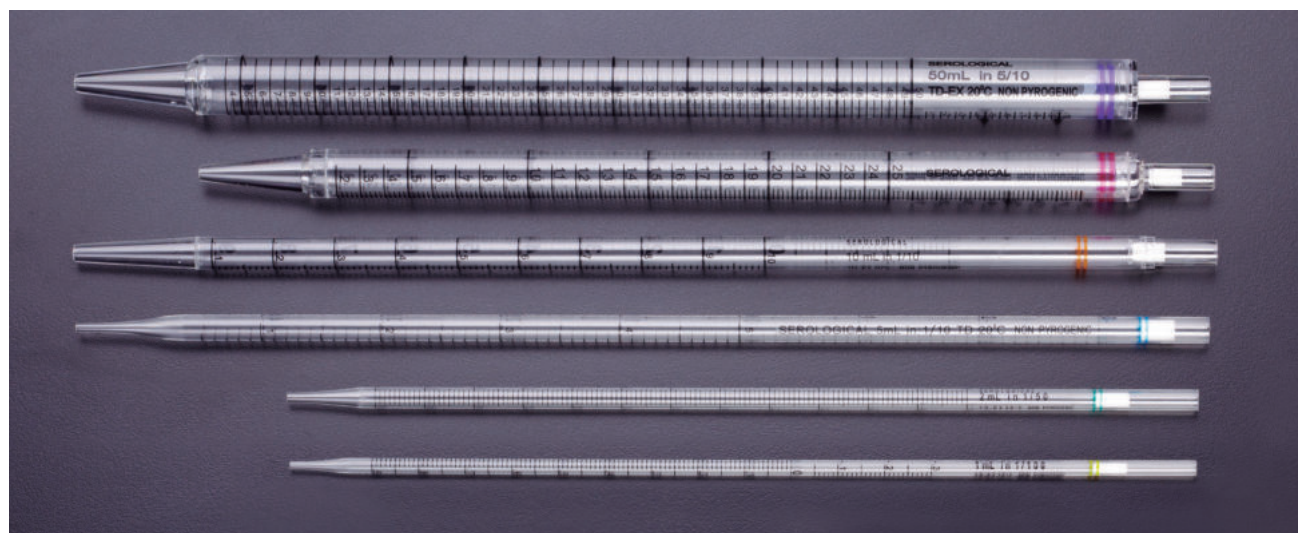



EUROTUBO® Pipetting bulb

This one-handed design is the simplest safety pipette filler to use available. Manufactured in natural orange rubber. Approx. drawn capacity: 25 ml. Single hand use, only two operating points. Evacuate via the automatic valve. Standard model, accommodates all pipettes. Ability to clean inside of bulb by removing patented valve and rinsing out.

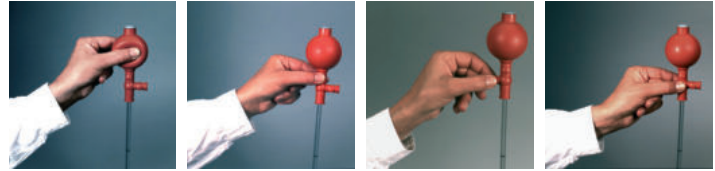

1. Evacuate the air by pressing the bulb, as the drawing indicates
2. Intake by pressing on point B (↑)
3. Drain the liquid by pressing on point A (↓)
4. Blow out the pipette by pressing as the drawing indicates (point C).

code	description	bag quantity	bag weight	bag volume
19200	pipetting bulb	1	0.05	0.0004



Pipetting bulb

Made of rubber.
Used to avoid mouth pipetting and contamination risk.
Can be opened, cleaned and **autoclaved**.
Ideal for Wintrobe and Westergren pipettes.



code	description	bag quantity	bag weight	bag volume
19201	red pipetting bulb	1	0.04	0.0002



Pipette pumps

Several models for various pipette volumes.
Designed for fast and efficient pipetting with simple, one handed operation.
Pipettes fit smoothly into collar.
Rotate the knurled thumb wheel on the side for precision filling or dispensing, and press the fast release lever for quick emptying.
Easy to use and easily disassembled for cleaning.
Sizes are colour coded.
Pipette pumps resist acids and alkalis.



Pipette pump support rack
See chapter **Hygiene and safety**.

code	description	colour	bag quantity	bag weight	bag volume
W-100	up to 2 ml	blue	1	0.06	0.0002
W-110	up to 10 ml	green	1	0.06	0.0002
W-120	up to 25 ml	red	1	0.06	0.0002

Sterile Whirl-Pak® blender bags with and without filter

Bags made of a low density polyethylene blend, resulting in an **extra-resistant and transparent bag**.

Leakproof closure with several metallic rounded sticks (see how to use it on figures on page 110).

Codes **200373**, **200374** and **200376** feature a **filter layer** of finely **perforated polyethylene**, to separate the liquid and solids. This allows the **easy pipetting of the sample**. There are 6.45 holes per cm², each one measuring 330 microns diameter. Bags with a **one-piece seam**, avoiding the possible risks of the loss of the corners bags. They feature a write-on strip (excluding codes **200342** y **200343**).

Ethylene Oxyde sterilised. Made with materials suitable for alimentary use.

mod.	code	description	alimentary use	capacity ml	dimensions cm	thickness microns	case quantity	case weight	case volume
1	200342	standard bag	✓	390	13 x 19	76	500	2.50	0.0170
1	200343	standard bag	✓	720	15 x 23	102	500	3.88	0.0168
2	200351	bag with write-on strip	✓	1,650	19 x 30	102	500	5.66	0.0182
3	200373	bag with filter and write-on strip	✓	720	15 x 23	102	250	1.98	0.0166
3	200376	bag with filter and write-on strip	✓	1,650	19 x 30	102	250	3.88	0.0180
3	200374	bag with filter and write-on strip	✓	2,041	19 x 38	102	250	4.28	0.0170



Sterile bags for STOMACHER® blenders

Made of polyethylene. Thickness: gauge 300. Ideal for mixing and blending bacterial samples or when collecting toxic substances from food, fabrics, etc.

Irradiation sterilised. Supplied in bags of 25 units.

Code **15006** is a stainless steel rack for 14 bags. Side handles incorporated.

To close bags. May be used with the rack **15006**.

Compounded by a blue tubular piece (230 mm) and a white clip (197 mm) which tightens the bag around the blue tube.

Code **15007** is a clip to close and adjust bags onto the rack.

Also available non sterile versions. Please ask for the minimum order quantity and delivery time. Add an "S" at the end of the code.

mod.	code	description	capacity ml	case quantity	case weight	case volume
1	15001	bag 100 x 155 mm	80	100 x 25	5.00	0.014
2	15003	bag 180 x 300 mm	400	20 x 25	4.20	0.014
3	15004	bag 380 x 580 mm	3,500	200	6.12	0.013
4	15006	rack 390 x 200 x 240 mm	-	1	1.77	0.039
5	983047	clips*	-	200	4.30	0.04



* Tubular piece: 230mm | Clip: 197 mm | Diameter: 10mm

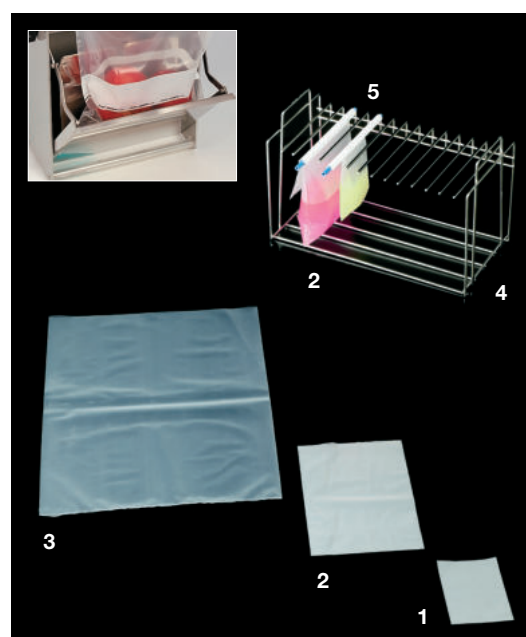



Sterile homogeniser lateral filter bag

Filter bag suitable for PCR and small volumes, it can be used with very short pipette. The unique and patented Pull-Up system allows to pinch the bag and pull up the filtered liquid for easy pipetting.

Nonwoven side filter having a porosity of 50 microns, rigid and transparent. The filtration is performed during homogenization, it is not necessary to wait for the sedimentation of particles.

Compatible with any lab blender.

Steriles by radiation.



code	packaging	case quantity	case weight	case volume
983045	homogeniser lateral filter bag 400 ml	10x25	2.72	0.010

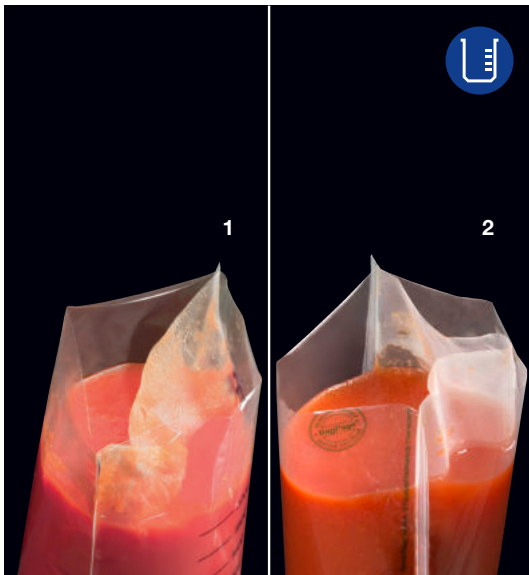

Sterile homogeniser full size filter bag

Bag made of transparent polyethylene (PE) divided in two parts by a filter:

15005: the filter is integrated into the bag.

122000: joined to the bag by a point in the upper part of the sheet.

The sample is inserted into one of the compartments and, after being homogenised and filtered, the solid particles remain in the initial compartment, while the liquid ones pass to the other compartment and can be extracted with a pipette without any risk of obstruction.

mod.	code	packaging	sterile	case quantity	case weight	case volume
1	15005	bag 180x310 mm	STERILE R	50x10	6.50	0.047
2	122000	bag 190x300 mm	STERILE R	20x25	5.92	0.020

mod.	code	filter	recommended working volume (ml)	maximum capacity (ml)	bag graduation
1	15005	286 holes/cm ²	50-400	1.600	YES (each 100 ml)
2	122000	280 microns	1.600	1.600	NO



Tissue grinders-homogenisers

Borosilicate glass vessels and serrated plunger. Tips: head made of TEFLON. shaft made of stainless steel. Fully **autoclavable**. The distance between the glass and the plunger is $\pm 200 \mu\text{m}$.

Glass vessels:

code	volume ml	body Ø mm	height mm	quantity	weight	volume
196102	2	8	120	1	0.01	0.001
196105	5	12	132	1	0.01	0.001
196110	10	16	150	1	0.02	0.001
196115	15	19	155	1	0.03	0.001

Plunger-serrated tips:

code	for tube of mm	height mm	quantity	weight	volume
196302	2	230	1	0.06	0.001
196305	5	235	1	0.06	0.001
196310	10	270	1	0.06	0.001
196315	15	270	1	0.02	0.001

Sterile bottles for water sampling

Rectangular body and cap made of polyethylene. The minor sides are gripped for a better handling. The larger sides are flat for labelling. Tamper evident red cap with an internal joint. Hermetical closure.

Sterilised by radiation.

Each bottle is labelled specifying description, code, lot, and expiry date.

Dimensions:

500 ml bottle: 83 x 65 x 135 mm - 1,000 ml bottle: 83 x 65 x 235 mm.

Mouth diameter intern: 28 mm.

Unitary weight (empty bottle):

500 ml bottle: 40 g - 1,000 ml bottle: 61 g.

Available with or without thiosulfate sodium

Bottles with liquid sodium thiosulfate (24 mg/l): Ideal to analyse water meant for human consumption, swimming pools, and any other water where chlorine may modify the composition of the sample while being transported.

Sterile bottles: Ideal to sample unchlorinated water for microbiological analysis, as well as for other sampling requiring sterile bottles.

code	description	sterile	capacity ml	case quantity	case weight	case volume	cases per pallet
282320	bottle with thiosulfate	STERILE R	500	24	1.35	0.025	48
282321	bottle with thiosulfate	STERILE R	1,000	20	1.67	0.033	42
282323	bottle with thiosulfate	STERILE R	500	111	6.00	0.110	16
282323.BU	bottle with thiosulfate, individually wrapped	STERILE R	500	111	6.04	0.110	16
282324	bottle with thiosulfate	STERILE R	1,000	68	5.15	0.100	16
282324.BU	bottle with thiosulfate, individually wrapped	STERILE R	1,000	68	5.41	0.110	16
282330	bottle sterile	STERILE R	500	24	1.36	0.025	48
282331	bottle sterile	STERILE R	1,000	20	1.37	0.033	42
282333	bottle sterile	STERILE R	500	111	5.92	0.110	16
282334	bottle sterile	STERILE R	1,000	68	5.15	0.110	16

We can supply any other concentration according to each country's standards.

For other volume bottles, please contact our sales department.

Optionally presented in individual bags if requested.



Please ask for customized labels



Whirl-Pak® surface sampling bags

New Whirl-Pak bags with spoon, dry or hydrated sponge with sample collection medium.

The buffered medium of the 200381 model contains monopotassium phosphate, sodium thiosulfate and aryl sulphonate complex.

Code 200381

Cellulose sponge, hydrated with 10 ml of neutralizing buffer.

The buffer will neutralize surface sanitizers, including quaternary ammonium compounds, phenolics, iodine preps, chlorine preps, mercurials, formaldehyde, and glutaraldehyde.

Diluent has a 24-month shelf life from the date of manufacture. Neutralizing buffer contains monopotassium phosphate, sodium thiosulfate, and aryl sulfonate complex.

Code 200382

532 ml write-on bag contains a sterile, disposable polystyrene plastic spoon of approximately 1 teaspoon capacity.

Code 200383

The 8" (20.3 cm) long bendable polypropylene handle allows maximum contact of the sponge with the sampling surface and also helps with the collection of hard-to-reach surfaces, around corners, and irregularly shaped areas.

The innovative twist-off head holds the cellulose sponge securely and is quick and easy to remove from the handle once sample collection is completed. Sterilized.

mod.	code	presentation	sterile	capacity ml	dimensions cm	thickness microns	case quantity	case weight	case volume
1	200381	Bag with hydrated sponge with medium	STERILE EO	532	11.5 x 23	63.5	100	2.5	0.019
2	200382	Bag with spoon	STERILE EO	532	11.5 x 23	63.5	100	1.02	0.007
3	200383	Bag with sponge	STERILE EO	710	15 x 23	76.2	1.14	0.014	

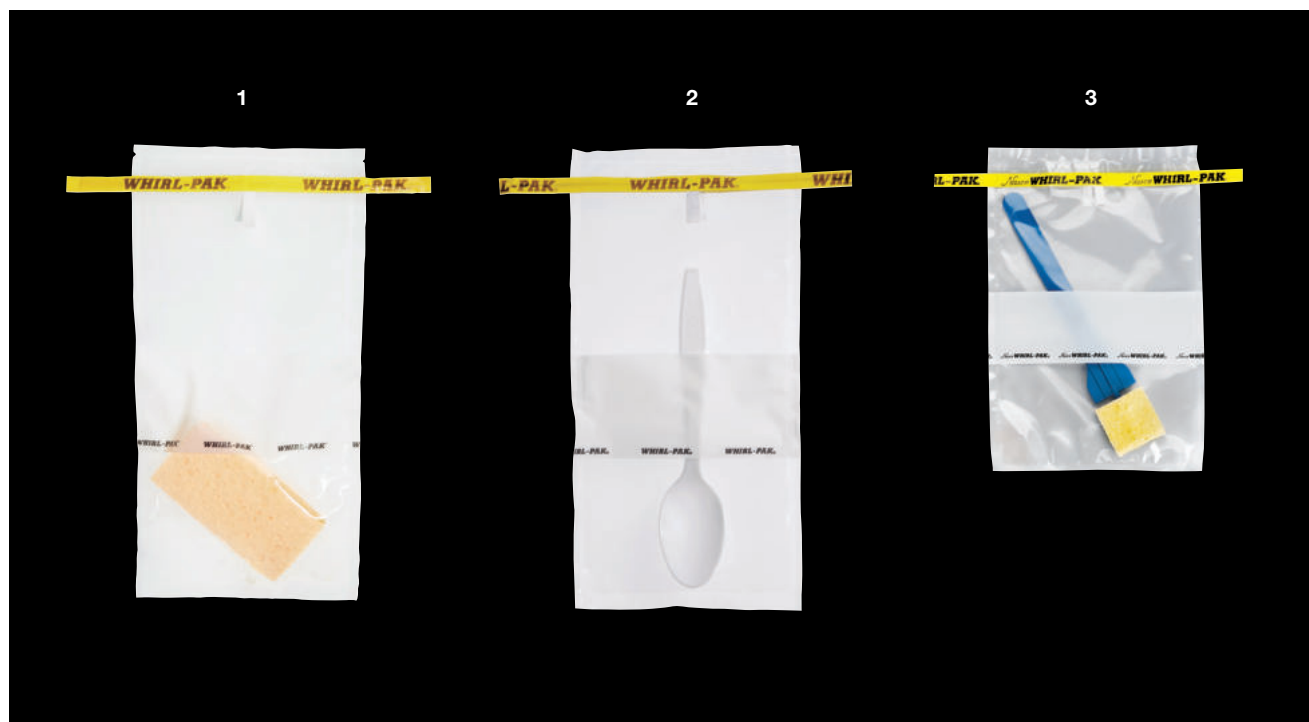

Whirl-Pak® bags with sodium thiosulfate

Bags used for collecting samples of drinking water and treated waters of swimming pools, sewage, etc. These bags tend to stand on their own, they are pre-sterilized, they are unbreakable, compact, with matte band for identification and closure. It is totally waterproof. They contain 10mg sodium thiosulfate tablets inside for each 100ml of water.

code	description	capacity ml	dimen. cm	thickness microns	case quantity	case weight	case volume
292601	Stand-up bag with thiosulfate	100	7.5 x 18.5	63.5	100	0.45	0.002
292602	Stand-up bag with thiosulfate	300	11.5 x 23	76.2	100	0.68	0.003
292605	Stand-up bag with thiosulfate	500	15 x 23	76.2	100	1.14	0.010
292606	Stand-up bag with thiosulfate	1,000	15 x 38	101.6	100	1.7	0.015



Long-handled dippers

Polypropylene cup and polyethylene handle. For convenient sampling from tanks, vats, streams, ponds, lakes, etc. These dippers are light, easy to use and portable. The polypropylene cups have threaded fittings that screw onto the handle. Two pouring spouts on the 500 ml dipper make it useful for left or right handed people to pour from either side. The end of the handle has a hook for hanging. Autoclavable container (up to 121°C).

code	description	quantity	weight	volume
19575	91 cm handle, 500 ml container	1	0.30	0.009
19576	183 cm handle, 500 ml container	1	0.76	0.020
19577	container 500 ml (fits either handle)	1	0.30	0.005

Please ask the commercial department for other lengths.

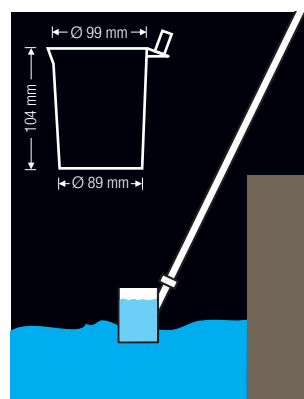

Sterile jars for water sampling

Transparent squared jars made of PET.

Wide mouth and grips at two sides, easing the sample collection.

Red cap made of polypropylene with internal liner made of polyan with a label that performs as tamper evident.

Sterilised by radiation. Each bottle is labelled specifying description, code, lot, and expiry date.

Internal mouth diameter mm: 55

Jar weight (gr):

500 ml jar: 44 g - 1,000 ml jar: 65 g

Available with or without thiosulfate sodium.

With liquid sodium thiosulfate (24 mg/l): Ideal to analyze water meant for human consumption, swimming pools, and any other water where chlorine may modify the composition of the sample while being transported.

Empty, without thiosulfate: Ideal to sample unchlorinated water for microbiological analysis, as well as for other sampling requiring sterile bottles.

mod.	code	description	sterile	capacity ml	case quantity	case weight	case volume	cases per pallet
1	282340	jar with thiosulfate	STERILE R	500	44	2.68	0.036	40
2	282341	jar with thiosulfate	STERILE R	1,000	48	4.30	0.076	20
3	282350	jar without thiosulfate	STERILE R	500	44	2.68	0.036	40
4	282351	jar without thiosulfate	STERILE R	1,000	48	4.30	0.076	20

We can supply any other concentration according to each country's standards.

We can also dose thiosulfate in other jars from our catalogue.

Optionally presented in individual bags if requested.

*Minimum ordering quantity: 1 pallet.



See industrial funnels on chapter
Laboratory and industrial packaging

Please ask for customized labels



Surface Kit

The new surface kits are supplied with a swab and a tube containing a buffered broth with neutralising agents.

Kits are intended for surface sampling for subsequent microbiological analysis. The kit is a single use product and is **sterilised by radiation**.

The swab is composed of a polystyrene support with a breakpoint (only reference **200398**) and a viscose tip.

The tube incorporates a pressure or screwed cap.

The kit is intended to be used by skilled personnel, properly trained in surface sampling.

The kit is presented individually wrapped in a peel-pack format.

The kit is complemented with the sampling template (**200396P**).

It has a hole of 4x5 cm to perform the sampling, is **sterile** and its supplied in a flow-pack. **Shelf life: 18 months**

Recommended for food industry, cosmetics, environment, veterinary, pharmacy, among others.

mod.	code	description	sterile	case quantity	case weight	case volume
1	200398	10 ml neutralising broth in skirted tube + viscose swab	STERILE R	2 x100	4.50	0.030
2	200399	5 ml neutralising broth in non skirted tube + viscose swab	STERILE R	6 x100	10.26	0.0560
3	200398P	Surface sampling template 4x5 cm	STERILE R	20	0.75	0.0051



1



2



3

Meat sampling kit

Designed according to the international standard **ISO 17604**, which is taken as reference on European Directives and Rules about microbiology of food and animal feeding stuff – carcass sampling for microbiological analysis.

The kit includes:

- A bottle containing 25ml of sterile buffered peptone water
- A disposable sterile template, supplied in a flow pack bag
- A sponge

Expiry date: 16 months.

code	packaging	sterile	case quantity	case weight	case volume
200393.V	carcass sampling kit with sponge	STERILE R	10	3.00	0.010
200393P	template meat sampling	STERILE R	20	0.75	0.0051







**CELL CULTURE
MOLECULAR BIOLOGY**

 **deltalab**



Cell and Tissue Culture Multiwell Plates

Ideal for cell growth and cell yields on multiple, comparative and other analysis. Single position lid reduces the risks of cross-contamination and handling mistakes. Wells are labelled with alphanumeric codes for easy identification. Suitable for all common instruments and automation.

Lid included. Individually packaged.

Sterilized by radiation. Non-pyrogenic. DNase/RNase-free.

code	description	n° of wells	surface cm ²	sterile	case quantity	case weight	case volume
D200001	Surface treated	6	9.6	STERILE R	2 x 50 x 1	6.55	0.075
D200002	Surface treated	12	3.85	STERILE R	2 x 50 x 1	8.80	0.075
D200003	Surface treated	24	1.93	STERILE R	2 x 50 x 1	8.55	0.075
D200004	Surface treated	48	0.83	STERILE R	2 x 50 x 1	8.45	0.075
D200005	Surface treated	96	0.33	STERILE R	2 x 50 x 1	8.35	0.075

Cell and tissue culture flasks

Cell and Tissue Culture Flasks are perfect for cell growth and cell yields aim on little and medium input volume. Available in surface treated and non treated. Flasks surface is flat and free from striation to maximize usable growth area. Innovative angled neck design offers good pipet and cell scraper access in. Both flask sides have engraved graduation. Strict integrity tested.

Sterilized by radiation. Non-pyrogenic. DNase/RNase-free.

code vented	code not vented	description	max. vol. ml	surface cm ²	sterile	case quantity	case weight	case volume
D200020	D200010	non treated	25	12.5	STERILE R	4 x 5 x 10	3,00	0,030
D200021	D200011	non treated	50	25	STERILE R	4 x 5 x 10	5,40	0,040
D200022	D200012	treated	25	12.5	STERILE R	4 x 5 x 10	3,00	0,030
D200023	D200013	treated	50	25	STERILE R	4 x 5 x 10	5,40	0,040
D200024	D200014	treated	250	75	STERILE R	4 x 5 x 5	7,40	0,076
D200025	D200015	treated	600	182	STERILE R	2 x 4 x 5	6,30	0,060



Cell and Tissue Culture Dishes

Cell and tissue culture dishes are ideal containers for cell growth and yields point to a small and medium volume of input, and are also useful in sample separation, pretreatment, storage, etc. Available on treated surface.

The uniform thickness of the flat bottom wall guarantees a bottom without distortion.

Sterilized by radiation. Non-pyrogenic. DNase/RNase-free.

	code	diameter mm	cell growth area cm ²	sterile	case quantity	case weight	case volume
P35	D200035	33.2	8.5	STERILE R	96 x 10	5.00	0.028
P60	D200060	53.34	21.2	STERILE R	60 x 10	10.50	0.050
P100	D200100	88.5	60.8	STERILE R	30 x 10	10.08	0.076
P150	D200150	136.1	143.0	STERILE R	12 x 1	8.20	0.082



Cell Scrapers (normal and rotatable)

Normal version and rotating version

Material: blades/PE, handle/ABS

Special developed to make the process of scraping off and collecting cells more easier and effective.

Free rotating blade to twist to the desired direction. Total access to all corner. Small raised knobs on the handle

Individually packaged.

Sterilized by radiation. Non-pyrogenic. DNase/RNase-free.

code	description	Length cm	sterile	case quantity	case weight	case volume
D200034	Cell scrapper	25	STERILE R	100 x 1	1.3	0.01
D200030	Rotable cell scrapper	30	STERILE R	150 x 1	2.5	0.019



Cell strainer

Cell strainers are manufactured from a strong nylon mesh with evenly spaced mesh pores and gamma resistant. These cell strainers are sterile, rapid, easy-to-use devices for isolating primary cells to consistently obtain a uniform single-cell suspension from tissues.

Protect your valuable flow cytometry and cell sorting instrumentation by reliably removing clumps and debris from cell suspensions and clinical samples prior to analysis. Improved uniformity of single cell suspensions.

Made of a strong nylon mesh with evenly spaced mesh pores. The extended lip on the strainer enables aseptic handling with forceps

Ready-to-use. **Individually packaged.**

Sterilized by radiation. Non-pyrogenic. DNase/RNase-free.

code	capacity (µm)	colour	sterile	case quantity	case weight	case volume
D200031	40	blue	STERILE R	4 x 50 x 1	1.32	0.018
D200032	70	natural	STERILE R	4 x 50 x 1	1.32	0.018
D200033	100	yellow	STERILE R	4 x 50 x 1	1.32	0.018





Vacuum filtration

Vacuum filters are very useful in large volume samples separation and purification. Available with 5 membrane sorts of PVDF and PES. 2 membrane pore sizes of 0.22µm and 0.45µm. 4 volumes size of 150, 250, 500 and 1000ml

Individually packaged.
Sterilized by radiation. Non pyrogenic. DNase/RNase-free.

code	funnel capacity	pore size (µm)	membrane	diameter (mm)	sterile	case quantity	case weight	case volume
D300000	1,000	0.22	PVDF	91	STERILE R	12 x 1	3.65	0.066
D300001	500	0.45	PVDF	75	STERILE R	12 x 1	3.65	0.066
D300002	150	0.22	PES	50	STERILE R	12 x 1	3.65	0.066
D300003	250	0.22	PES	50	STERILE R	12 x 1	3.65	0.066
D300004	500	0.22	PES	75	STERILE R	12 x 1	3.65	0.066
D300005	1,000	0.22	PES	91	STERILE R	12 x 1	3.65	0.066

15 ml and 50 ml centrifugal tubes

Made of polypropylene, suitable for both clinical and research applications. DNAsa, RNAsa and pyrogen free. They are also free from natural rubber and heavy metals. Centrifugation resistance: 14.000 xg, except code 429931: 7.500 xg and codes 429950, 429951: 3.500 xg
See more technical information on page 37.

code	description	presentation	sterile	case weight	case volume	cases pallet
15 ml tubes						
429940	non-skirted tube	500 tubes in bulk	no	500	4.50	0.034
429945	non-skirted tube	20 bags of 25 tubes	no	500	4.50	0.0281
429942	non-skirted tube	20 bags of 25 tubes	STERILE R	500	4.35	0.04
50 ml tubes						
429930	non-skirted tube	20 bags of 25 tubes	no	500	7.70	0.09
429931	non-skirted tube	20 bags of 25 tubes	STERILE R	500	7.44	0.108
429950	skirted tube	20 bags of 25 tubes	no	500	8.80	0.09
429951	skirted tube	20 bags of 25 tubes	STERILE R	500	8.80	0.108



Sterile culture tubes in polystyrene

Tubes supplied with either a two position ribbed polyethylene cap, which can be left loose for aerobic work or sealed for anaerobic cultures. They are biologically inert, exempt from mold release agents, and withstand up to **1,400 xg** and **70 °C**. Packaged in self-standing resealable zip-lock bags of 125 units.



Loose position for aerobic work



PosSealed position for anaerobic cultures

code	dimensions mm	volume	case quantity	case weight	case volume
300807	12 x 75	5ml	8 x 125	4.24	0.033
300808	17 x 100	14ml	8 x 125	7.14	0.060



Sterile serological pipettes

Made of glass polystyrene. Single use only. Serological pipettes have an accuracy of +/- 2% at full scale. **Sterilized by radiation**. Manufactured in one, two or three pieces depending on the volume. **DNase and RNase free**. **BSE / TSE free**. Pyrogenic, non-cytotoxic and non-hemolytic. See more technical information on page 41.

code	capacity ml	presentation	cotton colour	tip	graduation ml	negative graduation ml	total capacity ml	case quantity	case weight	case volume
900030.C	1	1 peel-pack	●	A	0/0.9	until -0.3	1.3	500	2.59	0.019
900031.C	1	bag of 25	●	A	0/0.9	until -0.3	1.3	40 x 25	4.02	0.019
900130.C	1	1 peel-pack	●	C	0/0.9	until -0.3	1.3	500	2.59	0.019
900032.C	2	1 peel-pack	●	A	0/1.8	until -0.6	2.6	500	3.74	0.019
900033.C	2	bag of 25	●	A	0/1.8	until -0.6	2.6	40 x 25	6.70	0.019
900034.C	5	1 peel-pack	●	A	0/4	until -3	8	200	2.42	0.014
900038.C	5	bag of 25	●	A	0/4	until -3	8	20 x 25	6.38	0.019
900144.C	5	1 peel-pack	●	B	0/4	until -3	8	200	2.42	0.014
900036.C	10	1 peel-pack	●	A	0/9	until -3	13	200	2.73	0.014
900037.C	10	bag of 25	●	A	0/9	until -3	13	16 x 25	5.5	0.019
900136.C	10	1 peel-pack	●	C	0/9	until -3	13	200	2.32	0.013
900146.C	10	1 peel-pack	●	B	0/9	until -3	13	200	3.82	0.014
900041.C	25	1 peel-pack	●	A	0/23	until -8	33	150	3.07	0.019
900043.C	50	1 peel-pack	●	A	0/46	until -10	60	100	2.54	0.019

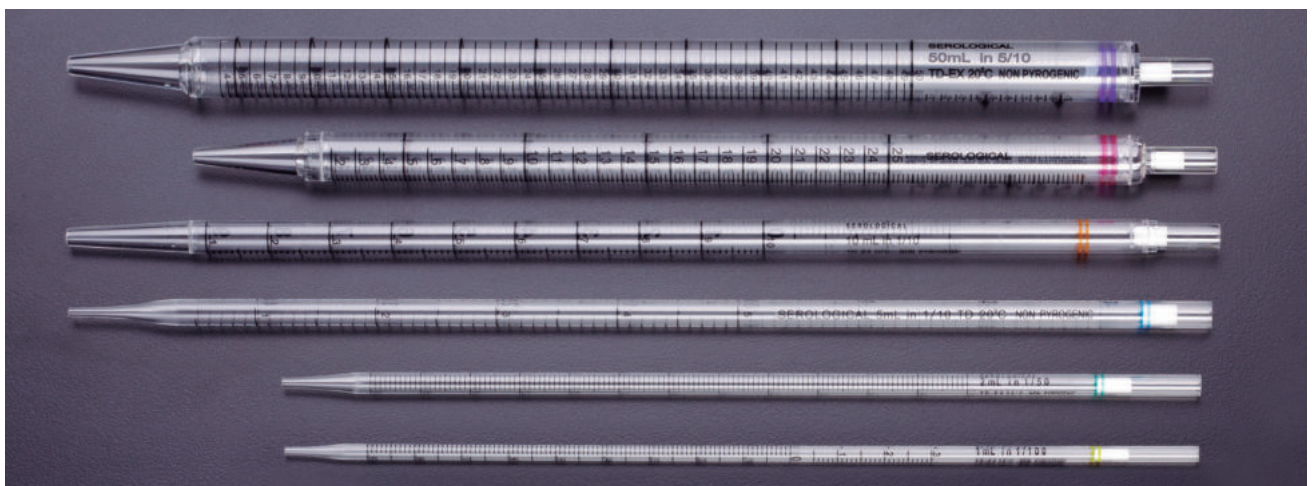



Screw thread microtubes

Made of autoclavable polypropylene, they can be used at extreme temperatures from $-190\text{ }^{\circ}\text{C}$ to $+121\text{ }^{\circ}\text{C}$. Two versions available: in transparent polypropylene, or opaque brown (UV resistant, designed to be used with light sensitive samples). **Certified RNase, DNase and pyrogen free.** Tubes and caps can be centrifuged at **17,000 xg**. Caps are supplied separately, see below. **Dimensions:** 11 x 44 mm.

mod.	code	volume ml	skirt	case quantity	case weight	case volume
Transparent polypropylene						
1	409110.1	0.5	yes	1,000	1.47	0.010
2	409110.2	1.5	yes	1,000	1.45	0.009
3	409110.3	1.5	no	1,000	1.13	0.007
4	409110.4	2.0	yes	1,000	1.30	0.013
Brown polypropylene						
5	409113.1	0.5	yes	1,000	1.54	0.009
6	409113.2	1.5	yes	1,000	1.34	0.009
7	409113.3	1.5	no	1,000	1.14	0.007
8	409113.4	2	yes	1,000	1.34	0.009

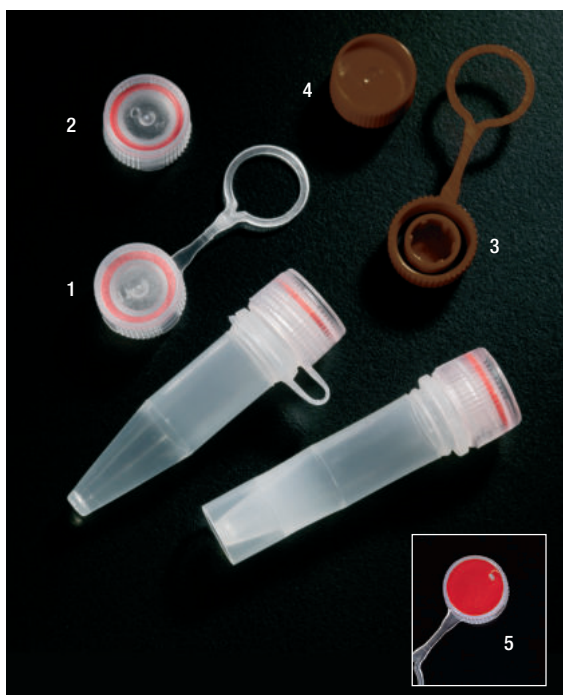

Caps for screw thread microtubes

Made of polypropylene. Caps are available either with an attachment loop or without loop. Both models have a sealing O-ring (red) of silicone to ensure a positive leakproof seal. For sample identification, colour coding inserts can be placed upon caps (made of polypropylene). **Cap dimensions:** 13 x 8 mm.

mod.	code	description	case quantity	case weight	case volume
Transparent polypropylene					
1	409007.N	cap with loop	1,000	0.41	0.003
2	409008.N	cap without loop	1,000	0.40	0.002
Brown polypropylene					
3	409007.M	brown cap with loop	1,000	0.45	0.003
4	409008.M	brown cap without loop	1,000	0.55	0.010
Inserts					
5	409111R	red insert	500	0.06	0.005



Screw cap microtubes, with cap. Sterile

Tubes and caps in medical grade, transparent polypropylene. The cap embodies a non-reactive ethylene-propylene o-ring. Suitable for autoclave, liquid nitrogen (gaz) and boiling processes. Perfect for long term storage. Withstand temperatures from $-190\text{ }^{\circ}\text{C}$. **DNase, RNase, DNA, and PCR inhibitors free.** Centrifugation Resistance: **20,000 xg**. Graduated models feature a frosted area for writing. The non-graduated model incorporates an external grip for an easy handling. Microtubes are supplied capped, in bags of 50 units. **Dimensions:** 44.45 x 12.95 mm

code	volume ml	skirted	sterile	graduation	case quantity	case weight	case volume
409115/4	0.5 ml	yes	STERILE R	✗	50 x 50	5.90	0.030
409115/2	1.5 ml	no	STERILE R	✓	50 x 50	5.90	0.030
409115/6	2 ml	yes	STERILE R	✓	50 x 50	5.90	0.030
409115/3	2 ml	no	STERILE R	✓	50 x 50	5.90	0.030

Screw thread microtubes

Made of transparent polypropylene. Suitable for use in liquid nitrogen, autoclave and for boiling applications, and can be used at temperatures down to $-190\text{ }^{\circ}\text{C}$. Products ideal for long term sample storage. **Certified RNase, DNase and PCR inhibitors free.** Withstand centrifugation at **20,000 xg**. The codes **409111/4**, **409111/5** and **409111/6**, with external moulded slots for better handling with gloves. **Dimensions:** 10.3 x 44.5 mm (except code **409111/2**: 10.3 x 43.6 mm). Caps are supplied separately, see below.

mod.	code	description	skirted	graduation	case quantity	case weight	case volume
1	409111/4	0.5 ml	yes	✗	500	0.78	0.005
2	409111/2	1.5 ml	no	✓	500	0.61	0.005
3	409111/5	1.5 ml	yes	✗	500	0.73	0.005
4	409111/3	2.0 ml	no	✓	500	0.71	0.005
5	409111/6	2.0 ml	yes	✗	500	0.76	0.005
6	409111/7	2.0 ml	yes	✓	500	0.73	0.005

Caps for screw thread microtubes

Made of medical grade polypropylene. Feature an internal O-ring to ensure leakproof seal. **Certified RNase, DNase and PCR inhibitors free.** **Dimensions** 13.0 x 6.0 mm.

code	colour	case quantity	case weight	case volume
409112/0	natural	500	0.019	0.0009
409112/1	blue	500	0.019	0.0009
409112/2	green	500	0.019	0.0009
409112/4	red	500	0.019	0.0009
409112/6	yellow	500	0.019	0.0009

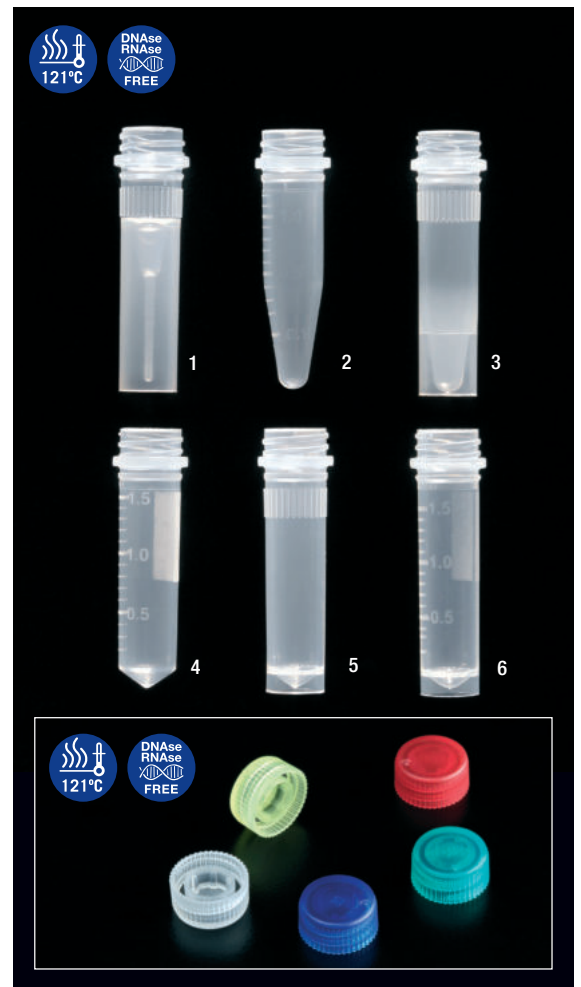

Screw thread tamper evident microtubes

Microtubes and caps are made of autoclavable ultra clear polypropylene. Ribbed cap with internal silicone O-ring for a positive **leakproof seal**. Super fast $\frac{1}{4}$ turn thread design. **Tamper evident** seal which notices if microtube has been opened. Used on:

- Test of fertility and DNA testing
- Packaging of diagnostic kits and reagents
- Forensic laboratories

They can be used at extreme temperatures from $-196\text{ }^{\circ}\text{C}$ to $121\text{ }^{\circ}\text{C}$. **Rnase, Dnase and Pyrogen free.**

Resistance to centrifugation: **17,000 xg**.

Microtube dimensions: 11 x 44 mm.

Cap dimensions (with tamper-evident ring): 15 x 9 mm



1. Screw cap until locking ring clicks over serrated tube neck.
2. Contents are now protected until cap is removed and tamper-evident ring is detached.

mod.	code	volume ml	case quantity	case weight	case volume
1	409110.4T	2	1.000	2.06	0.013
2	409110.2T	1.5	1.000	2.06	0.013

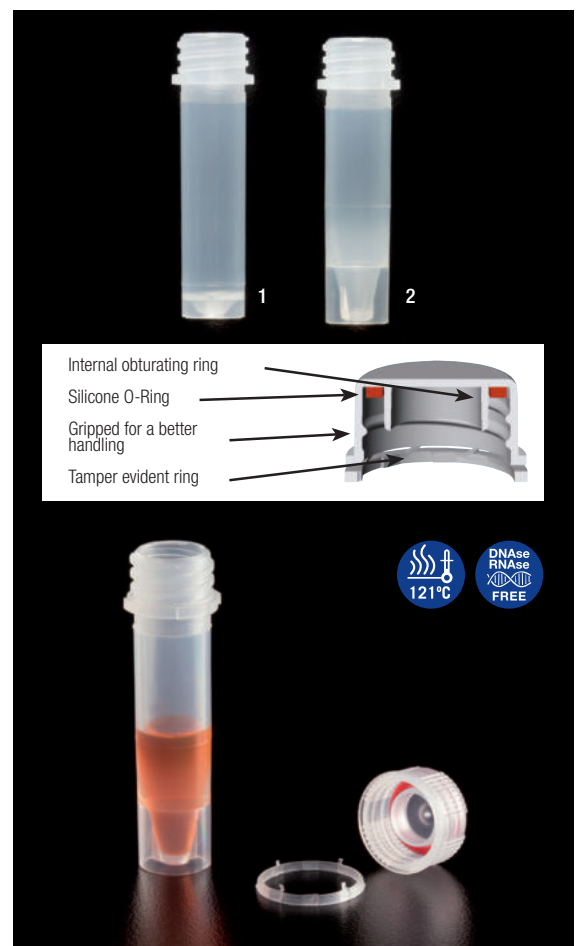



Human DNAsa, RNAsa and DNA free certified swabs, steriles

Human DNA free Certified. The swab is supplied in a polypropylene tube, which protects the sample up to the laboratory prior to its analysis.

The stick of the swab is made of polystyrene while the head is produced with viscose or polyester according to the code.

The tube is labeled indicating code, description, lot, expiry date and providing an identifying area to note down collection details (site, date, etc.).

Moreover, the label seals the tube with the cap of the swab, acting like a tamper evident system.

Sterilised by ethylene oxyde.



code	description	selling unit	case quantity	case weight	case volume
300252DNA	polystyrene + viscose	500	4 x 500	14.20	0.070

Expiry date: 48 months.



Cryovials with external threads

Non skirted versions withstand centrifugation up to **14,000 xg**.



code	volume ml	skirt	dimensions mm*	case quantity	case weight	case volume
409105.1	1.2	yes	12.5 x 42	10 x 100	2.50	0.014
409103.1	2.0	no	12.5 x 47	10 x 100	2.70	0.017
409106.1	2.0	yes	12.5 x 49	10 x 100	2.68	0.015
409107	3.0	yes	12.5 x 71	10 x 100	3.88	0.023
409108	4.0	yes	12.5 x 77	10 x 100	3.90	0.028
409109	5.0	yes	12.5 x 92	10 x 100	4.60	0.023
401410	10.0	yes	17.0 x 84	10 x 50	2.80	0.020

* Capped.



Cryovials with internal threads

Non skirted versions withstand centrifugation up to **14,000 xg**.



See Colour coded inserts at page 166

code	volume ml	skirt	dimensions mm*	case quantity	case weight	case volume
409001	1.2	yes	12.5 x 41	10 x 100	1.94	0.015
409002	2.0	no	12.5 x 48	10 x 100	2.22	0.016
409002.1	2.0	yes	12.5 x 49	10 x 100	2.24	0.015
409003	4.0	no	12.5 x 70	10 x 100	3.79	0.028
409003.1	4.0	yes	12.5 x 72	10 x 100	3.90	0.028
409003.2	5.0	no	12.5 x 90	10 x 100	4.60	0.024

* Capped.

0.2 ml Real Time PCR tubes

Tubes made of polypropylene, featuring attached hinged caps.
Flat caps are easily pierceable and offer optical quality, thus allowing their application in **Real Time PCR**.
Available in strips of 8 tubes (see code **4095.1NP** in the following page).
Certified **RNAse, DNase and PCR inhibitors free**.



code	description	case quantity	case weight	case volume
4094.5N	PCR 0.2 ml QPCR tube	1,000	0.25	0.003



0.2 ml PCR tubes

Tubes made of polypropylene, featuring attached hinged caps.
Caps are flat and easily pierceable.
See strips of these tubes on the following page (codes **4094.3N** and **4094.4N**).
Certified **RNAse, DNase and PCR inhibitors free**.



code	colour	case quantity	case weight	case volume
4094.1N	natural	1,000	0.24	0.003
4094.1A	blue	1,000	0.24	0.003
4094.1R	red	1,000	0.24	0.003
4094.1AM	yellow	1,000	0.24	0.003

Ask for minimum quantity and delivery time for other colours.

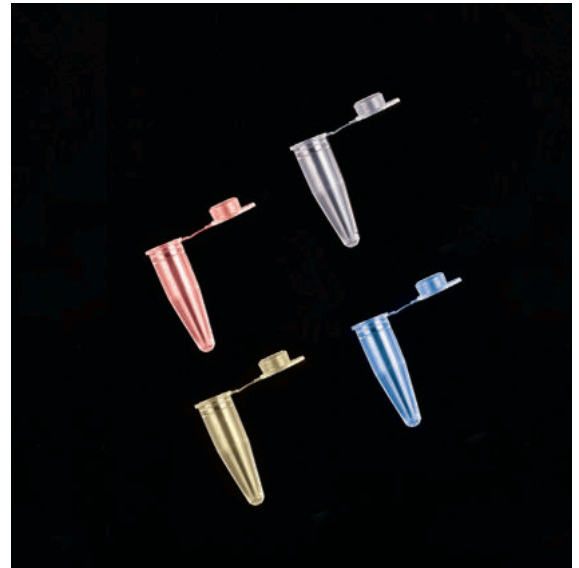

0.2 ml PCR tubes

Made of polypropylene.
Tubes with attached domed cap.
Certified **RNAse, DNase and PCR inhibitors free**.



code	description	colour	case quantity	case weight	case volume
4095.9N	individual tube with cap	natural	1,000	0.25	0.003



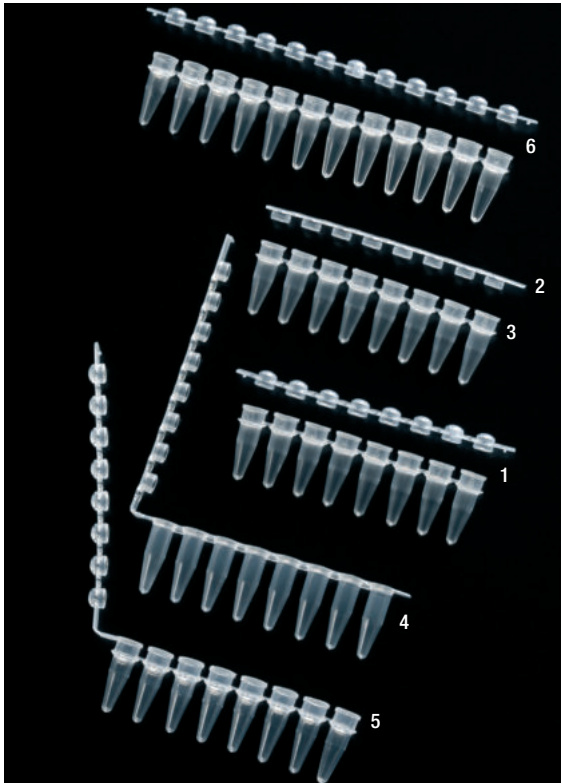

0.2 ml PCR tubes in strips

Made of natural colour polypropylene. Different models available:

- Strip of 8 or 12 tubes with its corresponding strip of 8 or 12 domed caps.
- Strip of 8 tubes with its attached hinged strip of domed caps.
- Strip of 8 tubes with its attached hinged strip of flat caps, suitable for **Real Time PCR**.
- Strip of 8 tubes.
- Strip of 8 flat caps, suitable for **Real Time PCR**.

Cap and tube strips allow easy handling and inventory of tubes and caps. Cap strips prevent cross-contamination from tube to tube.

Code **4095.7N** is also suitable for plates. **Certified RNase, DNase and pyrogen free.**



2, 3, 4

	code	description	case quantity	case weight	case volume
1	4095.2N	8 tube strip + 8 domed cap strip	125 strips	0.30	0.0036
2	4095.7N	strip of 8 flat caps	125 strips	0.07	0.0008
3	4095.6N	8 tube strip	125 strips	0.22	0.0028
4	4095.1NP	8 tube strip attached to 8 flat cap strips	125 strips	0.23	0.0036
5	4095.1N	8 tube strip attached to 8 domed cap strips	125 strips	0.23	0.0036
6	4095.4N	12 tube strip attached to 12 domed cap strips	80 strips	0.20	0.0028

Ask for another colours.

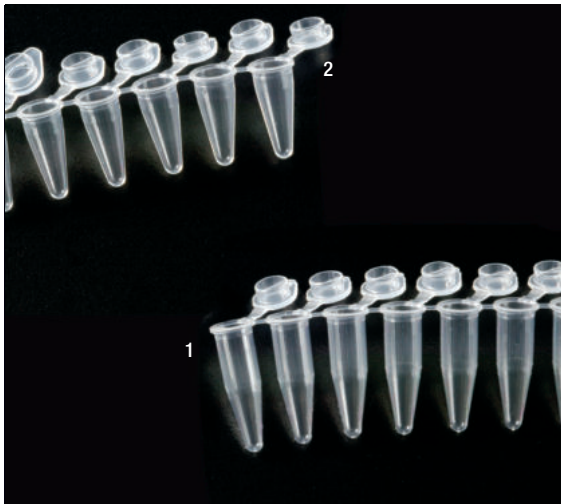

0.2 ml PCR tubes in strips

Tubes made of polypropylene, featuring attached hinged caps.

Suitable for **Real Time PCR**.

See individual tubes on page 67 (**4094.1N**). Caps are flat and easily pierceable. In bags of 10 strips.

Available in standard height (code **4094.3N**) and low profile (code **4094.4N**) that minimizes the effects of condensation and it allows working with small samples even less than 20 µl. **Certified RNase, DNase and pyrogen free.**



	code	description	case quantity	case weight	case volume
1	4094.3N	strip of 8 tubes and 8 attached caps	120 strips	0.27	0.0036
2	4094.4N	strip of 8 tubes and 8 attached caps low profile	120 strips	0.22	0.0028

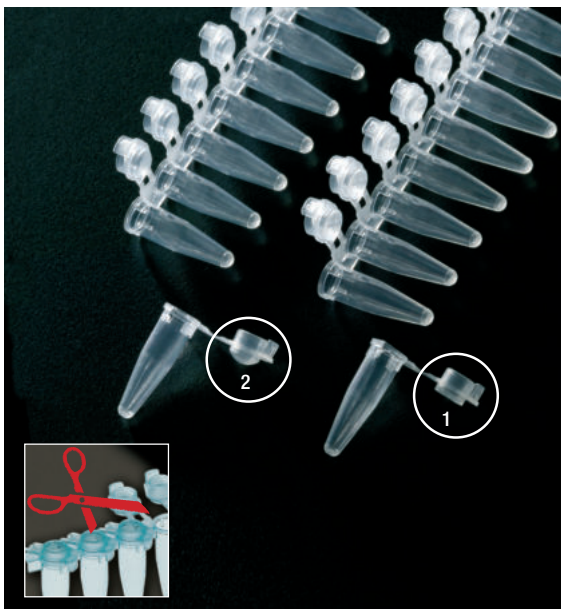

0.2 ml PCR tubes in strips

Made of polypropylene.

The strip includes 8 integral 0.2 tubes with ultra thin sidewalls and bottoms with individually attached caps. Available with either **flat (needle pierceable)** or **dome-topped individually** attached hinged caps.

Every cap embodies a shield in order to prevent contamination when being opened.

While easily opened and closed with one hand, their positive sealing will fully protect the contents from evaporation during the whole thermal cycle. These strips can be cut to any length while each tube has its own attached cap.

Certified RNase, DNase and pyrogen free.



	code	cap	case quantity	case weight	case volume
1	4096.2N	flat	125 strips	0.40	0.055
2	4096.3N	domed	125 strips	0.43	0.003



Real Time PCR

Polimerase Chain Reaction is one of the most common techniques in every lab where Molecular Biology is being used. Its applications comprise **Diagnostics, Genetic and Prenatal testing, Tissue Typing, Forensics, Pharmacological evaluation,** among others.

One of the **most useful PCR techniques** is the **Real Time PCR**, also known as **Quantitative PCR (QPCR)**. Its main advantage in front of standard PCR is that it **saves time as the quantification is being held during DNA amplification**. While standard PCR needs a quantifying process after DNA amplification, **QPCR gives results in real time**.

PCR standard consumables are mainly made of transparent polypropylene. After some years of experience, laboratory technicians have found that **crossalking among transparent wells may affect the real time quantification**. **Opaque white wells and tubes** have proved to avoid this well-to-well crossalking, thus **ensuring an exact and reliable quantification**.

Opac wells also allows luminosity absorption.

The following pages include the newest innovations in this brand new area; like **bi-mould technologies**, which allow the manufacture of an opaque tube attached to an optically clear cap.

White well technology is available in both strips of tubes or also 96 well plates.

0.2 ml, Real Time PCR tubes in strips

Tubes made of polypropylene.

Strip of 8 tubes, each one featuring an attached flat cap.

Strips are manufactured by biomaterial molding, so the tubes are made of opaque white PP, while caps are compounded of transparent, optically clear PP.

Opaque white tubes perform the highest performance in **Real Time PCR**, as they avoid crossalking between wells.

Specially conceived for **Real Time PCR**.

Caps are easily pierceable.

In bags of 10 strips.

Certified RNase, DNase and PCR inhibitors free.

Autoclavable at 121°C.



code	description	case quantity	case weight	case volume
4094.5BP	strip of 8 white 0.2 ml QPCR tubes and 8 attached caps	120	0.27	0.004

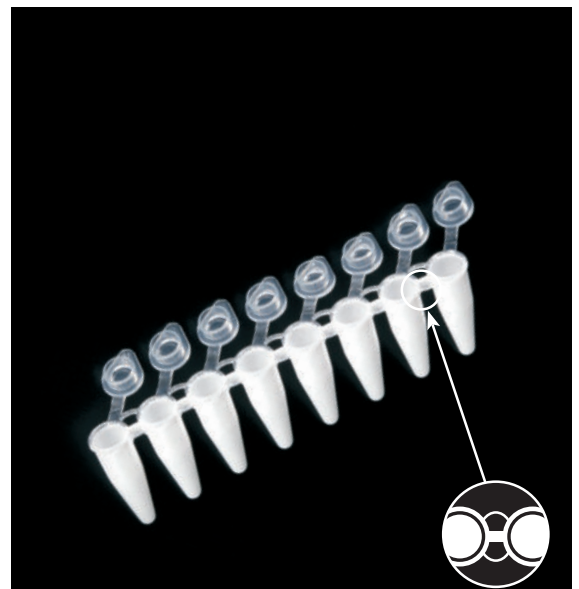

0.2 ml, Real Time PCR tubes in strips

Tubes made of polypropylene.

Strip of 8 tubes, featuring an attached strip of 8 flat caps. Strips are manufactured by biomaterial molding, so the tubes are made of opaque white PP, while caps are compounded of transparent, optically clear PP.

Opaque white tubes perform the highest performance in Real Time PCR, as they avoid crossalking between wells. Specially conceived for **Real Time PCR**.

Caps are easily pierceable.

Certified RNase, DNase and pyrogen free.

Autoclavable at 121°C.



code	description	case quantity	case weight	case volume
4095.1BP	strip of 8 white 0.2 ml QPCR tubes and 8 caps	125	0.23	0.004



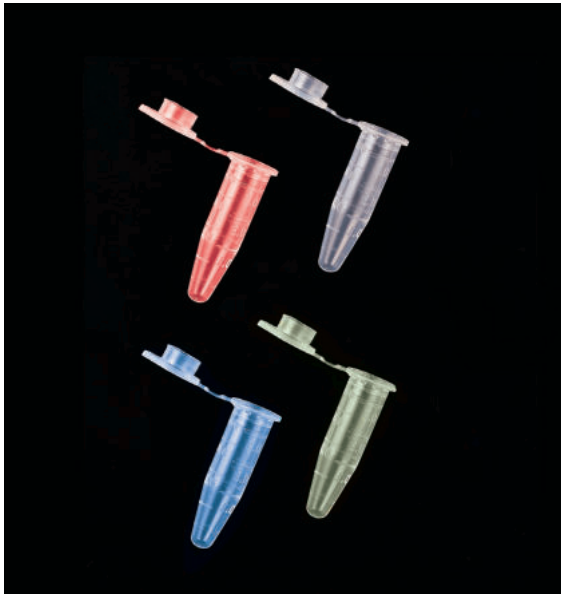

Graduated 0.5 ml PCR tubes

Made of autoclavable polypropylene. Attached hinged caps are flat and easily pierceable. Tubes are easily opened and closed with one hand. Tubes have moulded-in graduations in 0.1 ml increments from 0.1 up to 0.6 ml, and a frosted panel on their side for writing or labelling. **Certified RNase, DNase and pyrogen free.**



code	colour	case quantity	case weight	case volume
4094.2N	natural	1,000	0.38	0.005
4094.2AM	yellow	1,000	0.38	0.005
4094.2A	blue	1,000	0.38	0.005
4094.2R	red	1,000	0.38	0.005



Graduated 0.5 ml PCR tubes

Same features as the above tubes, but with a domed cap.



code	colour	case quantity	case weight	case volume
4095.5N	natural	1,000	0.46	0.005

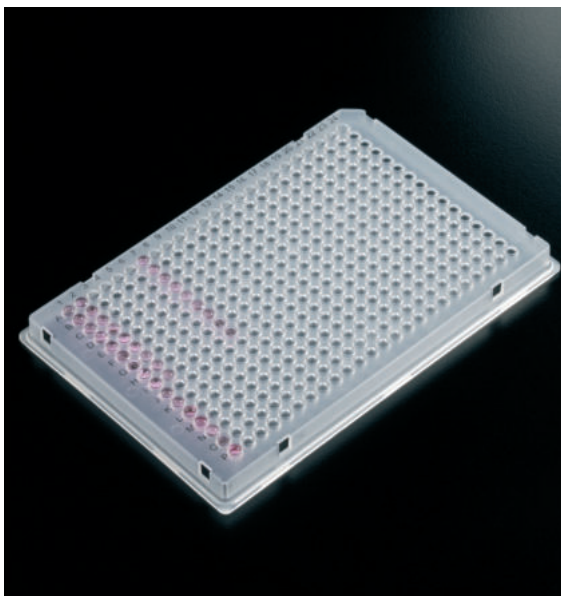

384 wells plate skirted

Made of transparent polypropylene. 384 wells plate. Each well has a capacity of 50 µl. A low rim around the top of each well helps to prevent accidental cross-contamination. All wells are thin walled for an excellent thermal transfer. Orientation cut is at position A 24 (upper right). A black printed alphanumeric grid helps sample identification. Suitable for **PCR** and **real time PCR (QPCR)**. Dimensions according to the **SBS** standard. **RNase, DNase, DNA and PCR inhibitors free.**



code	description	case quantity	case weight	case volume
900384	PCR 384 PLATE	10 x 10	3.20	0.026

Minimum order quantity: 10

PCR Plates – COMPATIBILITY CHART			900111	900110 unskirted	900122 semi skirt	900112 semi-skirt	900113B semi skirt	900123 skirted	900384 skirted	900098 unskirted	900095 white, skirted 900093 black, skirted	
Well Shape									50 µl			
Standard well. (Overall height approx. 21 mm, max. capacity approx. 350 µl)			●		●					●		
Low profile well. (Overall height approx. 16 mm, max. capacity approx. 200 µl)				●		●	●	●			●	
AMERSHAM	Thermal Cyclers	MegaBace 500						●			●	
		MegaBace 1000						●			●	
		MegaBace 4000							●			
APOLLO BRAND	Thermal Cyclers	ATC401	●						●	●		
APPLIED BIOSYSTEMS	Thermal Cyclers	GeneAmp® 2700	●		●				●	●		
		GeneAmp® 2720								●		
		GeneAmp® 9600	●		●					●	●	
		GeneAmp® 9700	●		●					●	●	
		GeneAmp® 9800 FAST BLOCK				●						
		Veriti 0,1 ml				●						
		Veriti 0,2 ml			●							
		Veriti 384							●			
		"Real Time" Cyclers	5700	●		●						●
	PRISM 7000		●		●						●	
	7300		●		●						●	
	7500		●		●						●	
	7500 "Fast"					●						
	7700		●		●						●	
	7900								●	●		
	7900HT Fast		●			●						
	7900HT Standard 96											
	7900HT, 384								●			
	Step one / Step One Plus				●							
	ViiA7™						●			●	●	
	Sequencers		PRISM 310				●					●
		PRISM 3100			●						●	
		3130 (XL)			●						●	
		3700 DNA			●				●	●		
		PRISM 3730 (XL)			●						●	
BECKMAN	Sequencers	CEQ	●									
BIOMETRA	Thermal Cyclers	Uno	●	●	●			●		●	●	
		Uno II	●	●	●				●	●		
		T1 Thermal Cycler	●	●	●			●	●	●	●	
		Tgradient	●	●	●					●	●	
		Trobot	●	●	●				●	●	●	
		TProfessional	●	●					●	●	●	
BIO-RAD/MJ RESEARCH	Thermal Cyclers	C1000/S1000	●	●	●			●	●	●	●	
		DNA Engine family	●	●	●			●	●			
		Dyad/Dyad Disciple	●	●	●			●	●			
		Gene cycler	●									
		iCycler	●		●			●		●		
		Mini Gradient	●	●							●	
		MyCycler	●								●	
		Personal	●		●							
		PTC-100	●	●	●			●	●	●	●	
		PTC-200	●	●	●			●	●	●	●	
		PTC-221									●	
		PTC-225 Tetrad	●	●	●			●	●	●	●	
		"Real Time" Cyclers	CFX384™							●		
	CFX96™							●			●	
	Chromo4™			●				●			●	
	iCycler™		●		●				●	●		
	iq™ 4 / iq™ 5		●		●					●		
	MiniOpticon™										●	
	MyiQ		●		●			●		●		
	MyiQ2	●		●			●		●			
Sequencers	Opticon™, Opticon 2™			●				●		●		
	BaseStation							●				



PCR Plates – COMPATIBILITY CHART			900111	900110 unskirted	900122 semi skirt	900112 semi-skirt	900113B semi skirt	900123 skirted	900384 skirted	900098 unskirted	900095 white, skirted	900093 black, skirted
Well Shape									50 µl			
Standard well. (Overall height approx. 21 mm, max. capacity approx. 350 µl)			●		●					●		
Low profile well. (Overall height approx. 16 mm, max. capacity approx. 200 µl)				●		●		●				●
CORBETT RESEARCH	Thermal Cyclers	PalmCycler 96		●	●			●				
		PalmCycler 384							●			
EPPENDORF	Thermal Cyclers	Mastercycler	●	●	●			●				
		Mastercycler Gradient								●	●	
		Mastercycler ep Gradient	●		●			●			●	●
		Mastercycler M384								●		
		Mastercycler Nexus	●	●	●			●				
		Mastercycler Nexus Eco	●	●	●			●				
	Mastercycler Pro	●	●	●			●			●	●	
“Real Time” Cyclers	Mastercycler ep Realplex	●	●	●			●		●	●		
ERICOM	Thermal Cyclers	Power Block I	●	●								
		Deltacycler I	●	●	●						●	
		Deltacycler II	●	●							●	
		Single Block	●	●	●						●	
ESCO	Thermal Cyclers	Swift	●		●							
		Gene	●		●			●	●			
G-STORM	Thermal Cyclers	GS1	●	●	●							
		GS2	●	●	●							
		GS4	●	●	●							
		GS5X	●	●	●							
		GSXs	●	●	●							
MWG	Thermal Cyclers	Primus 96	●	●	●			●		●	●	
		Primus 384								●		
PEQLAB	Thermal Cyclers	“Real Time” Cyclers	●	●				●		●	●	
		peqSTAR 96								●		
ROCHE	Thermal Cyclers	LightCycler 96					●					
		“Real Time” Cyclers	LightCycler 480					●				
SENSOQUEST	Thermal Cyclers	LabCycler Basic 96									●	●
		LabCycler Gradient 96									●	●
STRATAGENE	Thermal Cyclers	Robocycler 96	●		●						●	
		RoboCycler® Gradient	●		●			●				
		Gradient Cyler									●	●
		Mastercycler® Gradient									●	●
		MasterCycler®EP Gradient/Pro									●	●
		M384										
	Surecycler 8808		●						●			
“Real Time” Cyclers	Mx4000®	●								●		
Mx3000P®, Mx3005P™	●									●		
Mastercycler® ep realplex									●	●		
TAKARA	Thermal Cyclers	TP240						●				
		TP3000	●	●	●			●		●		
TECHNE	Thermal Cyclers	Genius	●	●	●						●	●
		Genius Quad	●	●	●						●	●
		Genius TC-412	●	●	●			●			●	●
		Genius, Touchgene, TC-512, TC-5000									●	●
		Prime / Prime G Full Size	●		●			●	●			
		TC Plus									●	●
		Touchgene	●	●	●							
	Touchgene Gradient (TC512)	●	●	●			●	●		●	●	
“Real Time” Cyclers	Touchgene X	●	●				●	●				
THERMO HYBAID	Thermal Cyclers	Quantica		●				●				
		MBS Satellite system	●	●	●			●	●	●	●	
		MultiBlock System									●	●
		Omn-E									●	●
		Omnigene	●	●	●			●	●	●	●	●
		PCR Express and Omni-E	●	●	●			●	●	●	●	●
		PCR Sprint	●	●	●			●				
		Px2 and PxE	●	●	●			●	●	●	●	●
Proflex	●		●					●				
TRANSGENOMIC	Sequencers	Touchdown	●	●	●			●	●	●	●	
		Wave						●				●

96-well flexible PCR plate

Made of polypropylene.

It is suitable for both real time and standard PCR thermocyclers.

This 96-well PCR plate is thin-walled for rapid thermal transfer. Flexible, the plate could be easily cut into sections of 24, 32 or 48 tubes.

An alphanumeric grid helps sample identification, and to facilitate orientation, the bottom right corner of the plate is cut away.

Certified RNase and DNase free.

Dimensions: 120 x 73 x 20 mm.

Dimensions according to the **SBS** standard.



code	colour	case quantity	case weight	case volume
900098	natural	10	0.22	0.0024

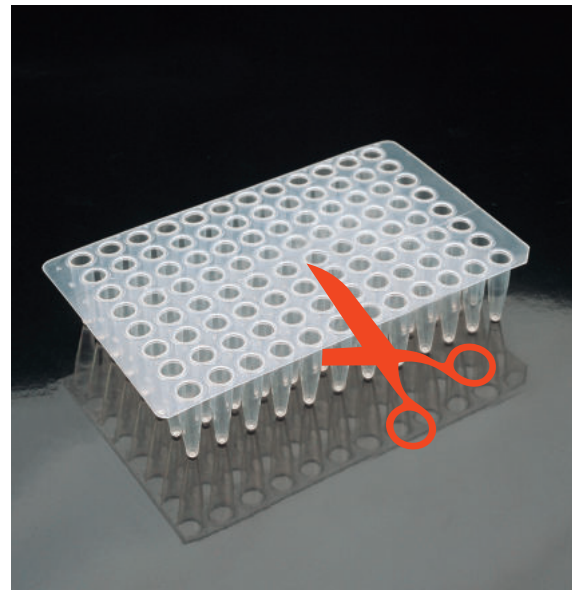

96-well low profile skirted PCR plate

Made of polypropylene. Each "low profile" well has a capacity of 200 µl. A low rim around the top of each well helps to prevent accidental cross-contamination and makes easy the sealing with film.

All wells are thin walled for an excellent thermal transfer.

This plate has a skirt approximately 15 mm high that can be filled using automatic fluid handling systems or standard multichannel pipettors.

A black printed alphanumeric grid helps sample identification.

Orientation cut is at position A 12 (upper right).

RNase, DNase, DNA and PCR inhibitors free.

Suitable for PCR and real time **PCR (QPCR)**.

Dimensions according to the **SBS** standard.



code	colour	case quantity	case weight	case volume
900123	natural	10	0.30	0.003

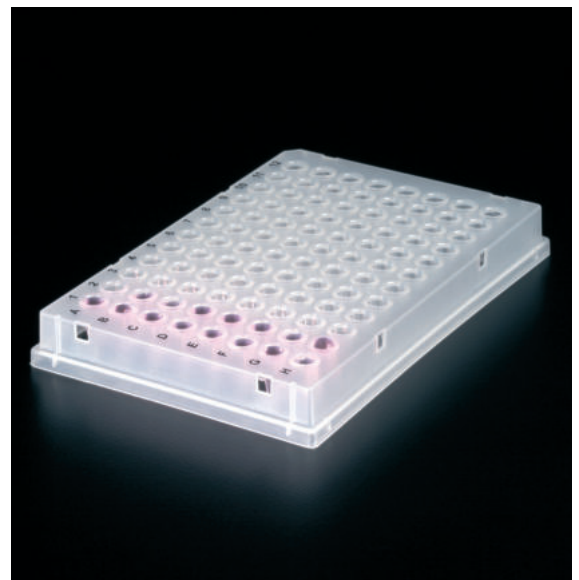

Opaque skirted 96 well PCR plate

Made of polypropylene.

Alphanumeric identification.

The skirt around the plate provides a labelling area. Conical-bottomed wells.

The plate can be handled by robotic equipment and is ideal with automated pipetting systems. To facilitate orientation, the bottom right corner of the plate is cut away.

Well dimensions: 5.5 mm. Well depth: 14 mm.

Code **900093**: Black plate for fluorescent PCR.

Code **900095**: White plate for luminescence (optical absorption) PCR.

Certified RNase and DNase free.

Dimensions: 126 x 84 x 15 mm.

Well plate volumen: 100 µl.



code	description	case quantity	case weight	case volume
900093	96 well black plate	5 x10	1.35	0.010
900095	96 well white plate	5 x 10	1.35	0.010

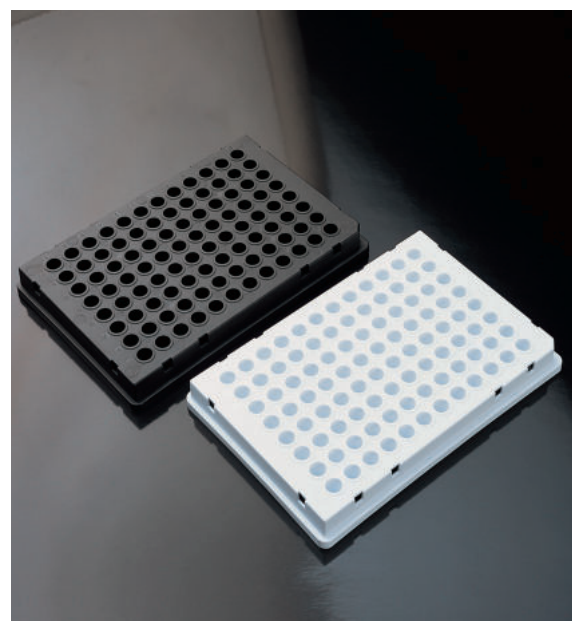

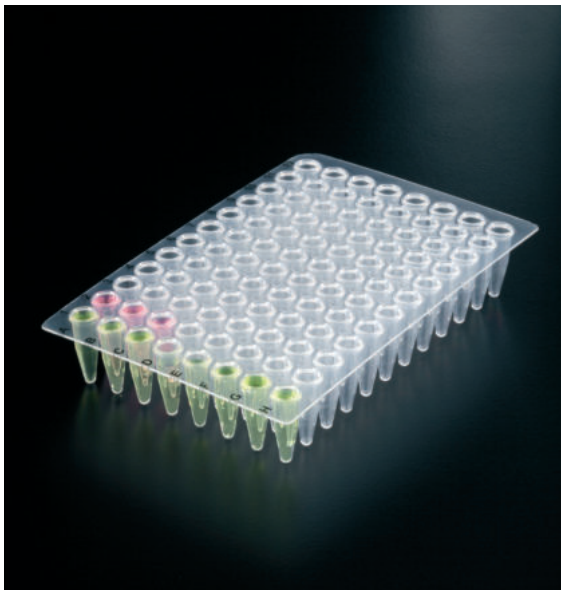

96 well standard plate

Made of transparent polypropylene.
 96 wells standard plate with a capacity of 350 µl each well.
 A low rim around the top of each well helps to prevent accidental cross-contamination and makes easy the sealing with film.
 All wells are thin walled for an excellent thermal transfer.
 A black printed alphanumeric grid helps sample identification.
 Orientation cut is at position A 12 (upper right).
RNase, DNase, DNA and PCR inhibitors free.
 Suitable for PCR and real time PCR (QPCR).
 Dimensions according to the SBS standard.



code	colour	case quantity	case weight	case volume
900111	natural	10 x 10	2.72	0.027

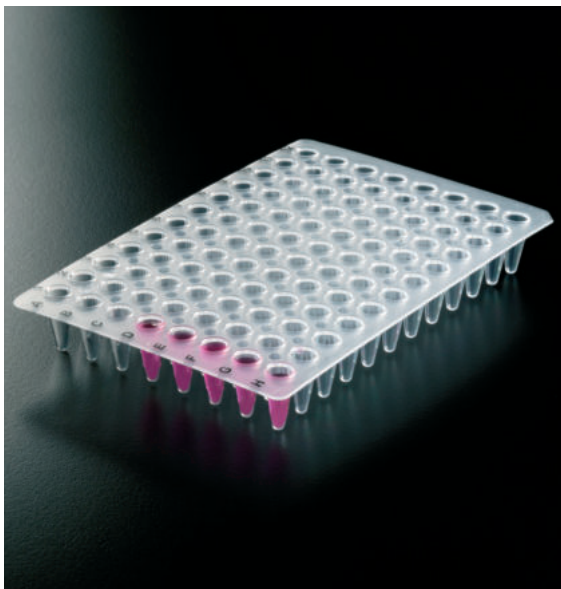

96-well low profile PCR plate

Made of transparent polypropylene.
 Low profile well (15 mm high).
 Perfect to work with samples of 100 µl or even less.
 A low rim around the top of each well helps to prevent accidental cross-contamination.
 The orientation cut is at position H 12 (lower right).
 A printed alphanumeric grid helps sample identification.
DNase, RNase, DNA and PCR inhibitors free.
 It is suitable for both standard or Real Time PCR.
 Dimensions according to the SBS standard.



code	description	case quantity	case weight	case volume
900110	low profile PCR plate	5 x 20	1.9	0.018

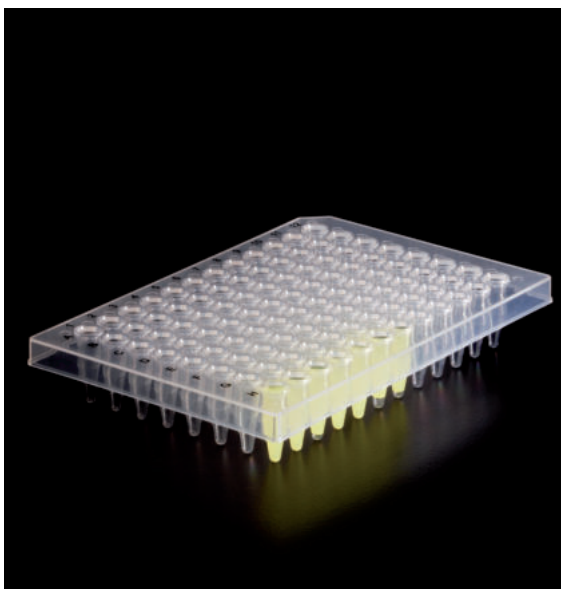

96 well semi-skirt plate

Made of transparent polypropylene.
 This plate has a semi skirt ±7.5 mm high.
 Each well has a capacity of 200 µl and embodies a low rim around its top which prevents accidental cross-contamination and it makes easy the sealing with foils.
 Orientation cut is at position A 12 (upper right).
 Alphanumeric identification printed in black.
DNase, RNase, DNA and PCR inhibitors free.
 Dimensions according to the SBS standard.



code	description	case quantity	case weight	case volume
900122	semi-skirt PCR plate	10	0.32	0.003

96 wells low profile, semi-skirted white plate

Specially designed for Roche thermocycler.

Made of white polypropylene. Semi-skirt "low profile" 96 well. Each well has a capacity of 200 µl.

A low rim around the top of each well helps to prevent accidental cross-contamination and makes easy the sealing with film.

Orientation cut is at position H 12 (bottom right).

A black printed alphanumeric grid helps sample identification.

RNase, DNase, DNA and PCR inhibitors free.

Suitable for **PCR** and **real time PCR**.

Dimensions according to the **SBS** standard.

96 well, low profile, semi-skirted plate

Specially designed for ABI "Fast" thermocycler.

Made of transparent polypropylene.

Semi-skirt "low profile" 96 well.

Each well has a capacity of 200 µl.

A low rim around the top of each well helps to prevent accidental cross-contamination.

Orientation cut is at position A 1 (upper left).

A black printed alphanumeric grid helps sample identification.

RNase, DNase, DNA and PCR inhibitors free.

Suitable for **PCR** and **real time PCR (QPCR)**.

Dimensions according to the **SBS** standard.

code	description	case quantity	case weight	case volume
900113B	semi-skirt PCR plate	10 x 10	2.96	0.027

code	description	case quantity	case weight	case volume
900112	semi-skirt PCR plate	10 x 10	2.96	0.027

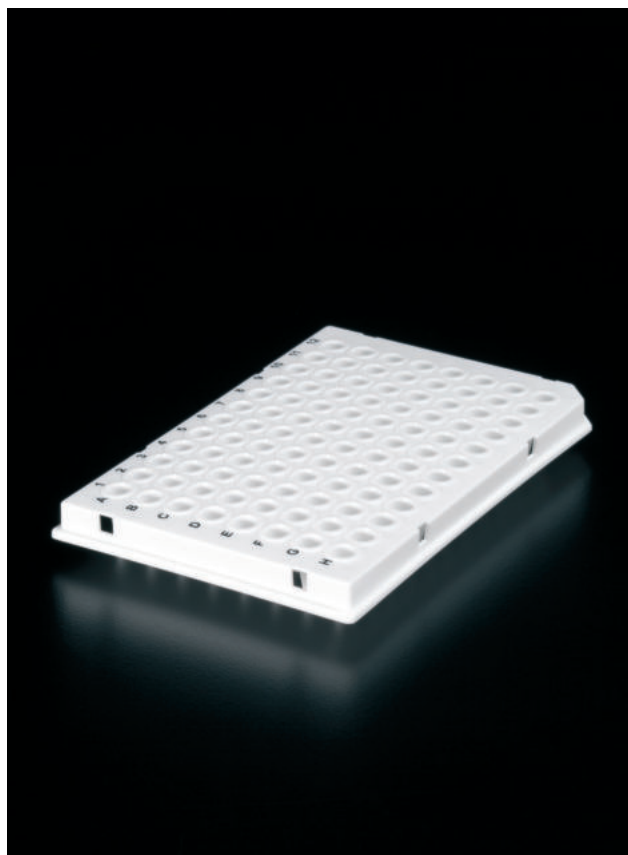

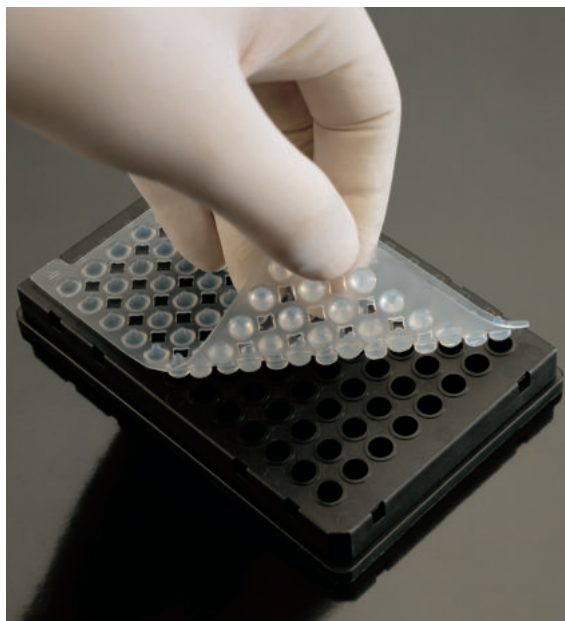

PCR sealing mat

Manufactured from a non reactive rubber, this PCR sealing mat ensures a secure, leak free seal during the PCR cycling process.

It is designed to seal **96 well PCR plates**, but may also be cut to fit 24/32/48 well plates.

The mat is marked "*this side up*" for a proper positioning into the plate (sharp cone side up). This sealing mat may be sterilised in an **autoclave** or cleaned by immersion in a bleach solution.

DNase, RNase, DNA and PCR inhibitors free.



See page 60

code	description	case quantity	case weight	case volume
900305	PCR sealing mat	10 x 5	1.20	0.012



Adhesive sealing film

Sealing film for use with microplates, multiwell plates and microtiter plates.

Advantages:

1. Minimises the risk of contamination or reagent spillage during ELISA or PCR processes.
2. Minimises the risk of contamination from tube to tube and from plate to plate.
3. Prevents sample evaporation.

A 5 mm wide strip (opaque white) at the lateral edges of the film helps pull the film from its protective paper and prevents it sticking onto fingers. The film is thermostable and functional from **-70 °C to 95 °C** at 75% humidity.

RNase and DNase free. DMSO resistant.

We recommend to use the "roller" **900330** to ensure a perfect seal.



code	description	case quantity	case weight	case volume
900300	adhesive film	1 x 100	0.23	0.0005
900301	adhesive film suitable for QPCR	1 x 100	0.06	0.0004
900330	sealing roller	1	0.01	0.0001



Aluminium sealing foil

This type of material is ideal for manual sealing during PCR work, microtiter plates or manipulation and file plates.

For high throughput applications from **-80 °C to 120 °C**.

Adhesive backing.

Pierceable with a pipette tip for easy access to sample.

DMSO resistant.

It is recommended to use the "roller" code **900330** for ensuring a perfect sealing, eliminating the danger of evaporation.

Dimensions: 14x8 mm

RNAsa, DNAsa and DNA free.

code	description	case quantity	case weight	case volume
900320	aluminium foil	1 x 100	0.28	0.0003
900330	sealing roller	1	0.01	0.0001

Deep well plate (96 square wells or 12 rectangular channels)

Made of medical grade polypropylene, composed of 96 wells. V-shaped bottom squares, each with 2 ml capacity. Numeration. Alphanumeric mold that facilitates the identification of samples. Widely used for dispensing and storage of liquids, since either by manual or automatic pipetting (robotic).

Resists temperatures from **-80 °C to 121 °C (autoclave)**.

Certified as free of RNase, DNase, DNA and PCR inhibitors.

Manufactured according to SBS standards. Stackable.

Sealing mat.

Made of autoclavable silicone, exclusive for square well plates.

Alphanumeric marking serigraphed in black for easy identification of wells.

It is pierceable, so it should not be removed to aspirate the sample.

It has 2 tabs on the right side for easy positioning.



mod.	code	description	case quantity	case weight	case volume
1	900198	96 well plate 2.0 ml	5	0.58	0.0032
2	900310	PCR sealing mat	10	0.14	0.0008

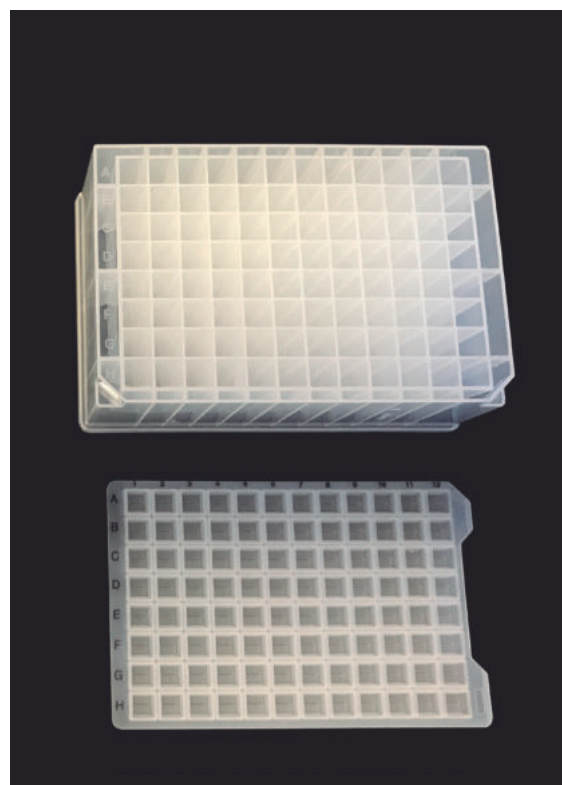

96 deep well plate (96 round wells)

Made of medical grade polypropylene, it is comprised of 96 round bottom wells, each one of 1.2 ml capacity. Printed alphanumeric grid helps sample identification, and to facilitate orientation the bottom right corner of the plate is cut away.

Widely used for liquid handling and storage, whether with manual pipetting or robotic handling.

It withstands temperatures from **-90 °C to 121 °C (autoclave)**.

Dimensions according to SBS.

Certified free from detectable RNase, DNase, DNA and PCR inhibitors.



code	description	case quantity	case weight	case volume
900156	96 well plate 2.0 ml	5	0.51	0.003

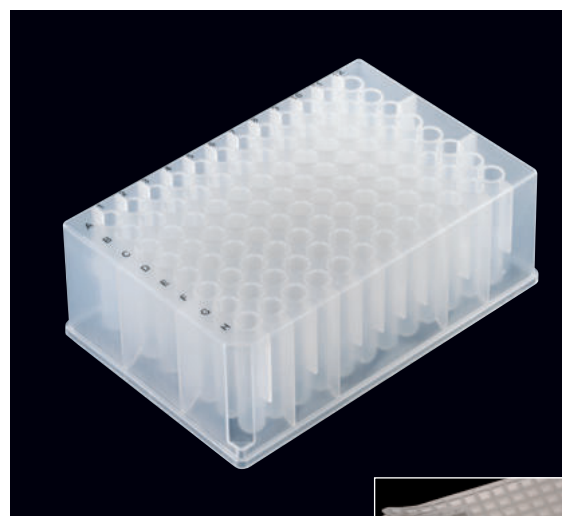

96 deep well plate (square well, round bottom)

Made of polypropylene. The 2.1 ml well capacity (2.0 when capped) plate is used mainly for compound storage and enzyme assays. An alphanumeric grid helps sample identification, and to facilitate orientation the bottom right corner of the plate is cut away. DMSO resistant. Can be centrifuged up to **6000 xg**.

Withstand temperatures up to **-150 °C. Autoclavable.**

Each well measures 8.3 x 8.3 mm.

Plate dimensions: 41.6 mm high x 127.8 mm long x 85.5 mm wide.

We recommend to protect the samples with the sealing mat code **900306** (DMSO resistant).



code	description	case quantity	case weight	case volume
900170	96 deep well plate, natural colour	4	0.47	0.002
900306	sealing mat	24	3.60	0.002



Sample storage system

96 round bottom tubes, supplied in twelve strips of eight tubes each, held in a rack with lid. Rack, lid, tubes and caps are made of **autoclavable** polypropylene, manufactured with the **SBS** standard footprint.

Compatible with all robotic applications and multichannel pipetting systems.

Alphanumeric numbered wells, indelibly printed in black, allowing identification in short light conditions. **DNase, RNase, DNA and PCR inhibitors free.**

Used for serial dilutions, mixing, storage and harvesting of cells, cell growth for cell culture assays and DNA screening, and as an ideal long-term storage system. Caps are sold separately in strips of eight or twelve units, depends on the model; every cap has a tag to make an easy opening and closing.

Tube dimensions (height): 8 x 44 mm

Rack dimensions (with lid): 128 x 86 x 48 mm

code	description	case quantity	case weight	case volume
409009	rack with 96 tubes (8 x 12)	10	1.63	0.010
409010	strips of 8 tubes each	125 strips	0.27	0.007
409011	strips of 8 caps each	125 strips	0.11	0.012
409012	loose tubes	1,000	0.63	0.005
409013	strips of 12 tubes each	80	0.126	0.001
409014	strips of 12 caps	80	0.662	0.006



Sample storage system

Compact sample storing system. It consists on a blue rack with a translucent lid, holding 96 loose round bottom tubes (1,2 ml) arranged in 8 x 12. Robotics suitable version (**RC845TP**). **Autoclavable** and stackable, it resists up to **-100 °C**, and embodies a moulded alphanumeric identification.

Rack, lid and tubes made of polypropylene. Caps made of low density polyethylene.

Caps are sold apart in strips of eight units; every cap has a tag to make an easy opening and closing.

Tube dimensions (height, closed): 8,8 x 45 mm.

Rack dimensions (with lid): 118 x 82 x 50 mm.

DNase, RNase.

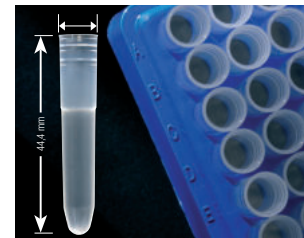

mod.	code	description	case quantity	case weight	case volume
1	409008	rack with 96 tubes (8 x 12)	10	1.40	0.007
2	RC845TP*	rack with 96 tubes for robotics	10	1.14	0.010
	409005	strips of 8 caps each	120 strips	0.16	0.002
	845	tubes in bulk	1,000	0.60	0.004

* pyrongen free

Sample storage system

It consists on a white rack and a transparent lid, with 96 tubes (12 x 8) 1.2 ml (capped, 1.1 ml).

Tubes and rack are manufactured in polypropylene, being autoclavable.

Caps in non **autoclavable** polyethylene.

Caps are acquired apart, in strips on eight units.

It is ideal to work with robots and multichannel pipetting systems, as well as for sample transport, storage, or freezing (it can withstand up to **-80 °C**).

It stands up the majority of chemical agents.

Both lid and rack embody an alphanumeric identification.

The top left edge of the lid is cut for an exact orientation.

Tube dimensions (capped): 9 x 48 mm.

Rack dimensions (with lid): 126 x 81 x 53 mm.

According to **SBS** standard.

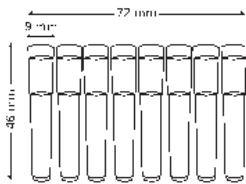

code	description	case quantity	case weight	case volume
409004	rack with 96 tubes (8 x 12)	10	1.80	0.009
408002	tubes of 8 caps each	120 strips	0.73	0.005
408005	strips of 8 caps each	120 strips	0.09	0.001
408003	loose tubes	5 x 960	3.88	0.028



Storage rack with 2 ml tubes

Compatible with most robotic Workstation, this polypropylene storage rack can be used with most cell harvesters and multichannel pipettors.

It contains 96 removable polypropylene square tubes in a 8 x 12 configuration, each having a 2.1 ml capacity.

Although the tubes are square, the bottom is round to facilitate emptying.

Tubes and rack are **autoclavable** and they are ideal for storage of blood and other biological samples at temperatures from **-30°C up to 70°C**.

Racks are stackable to save storage space.

According to **SBS** standard.

code	description	case quantity	case weight	case volume
418003	96 well storage rack with tubes	10	1.81	0.012

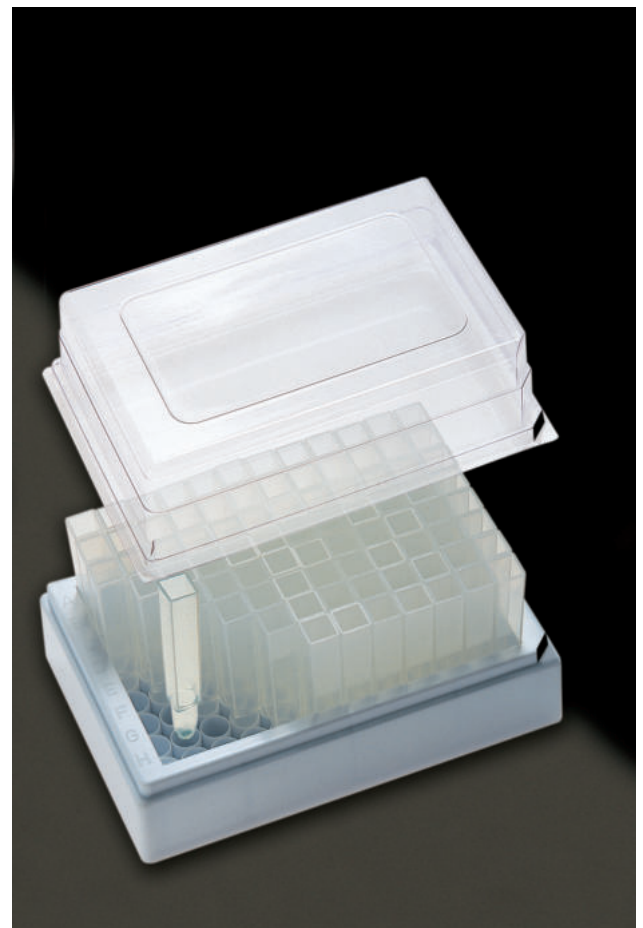

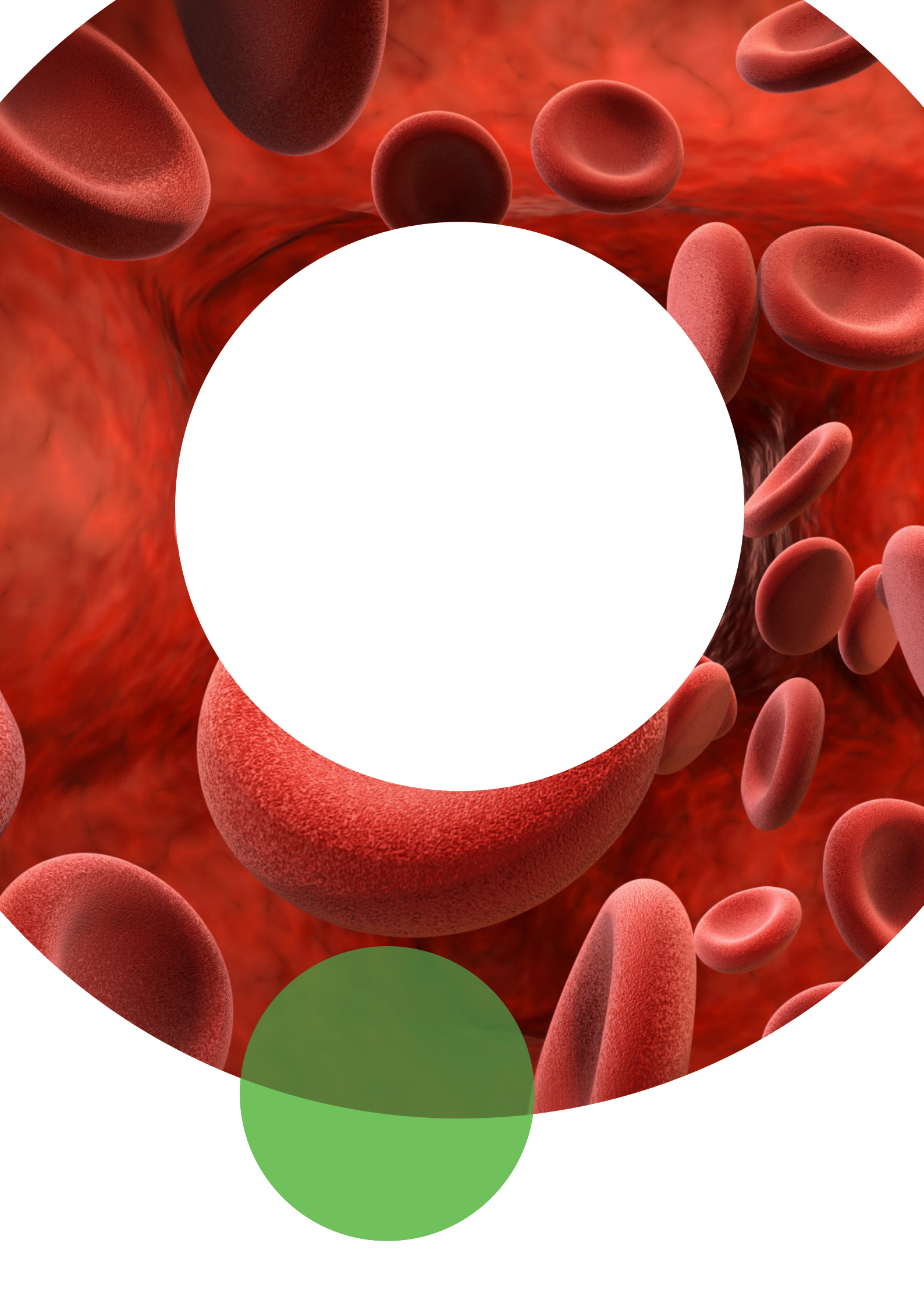

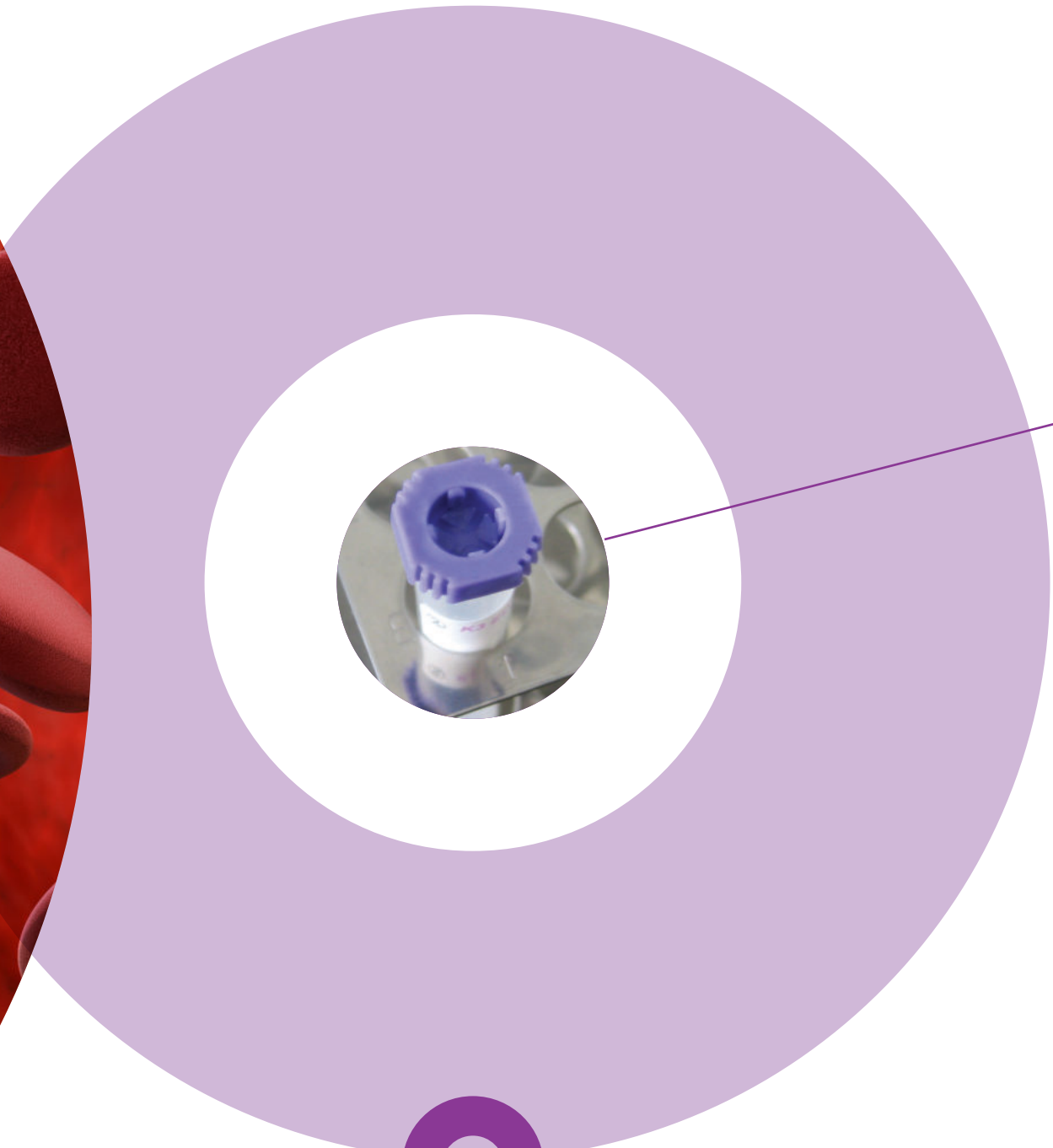

**HAEMATOLOGY
AND BIOCHEMISTRY**

 **deltalab**

Procedures and controls

During the manufacturing process of the tubes for extraction tubes, periodic checks are carried out, among which are:

- Reproducibility dosing control
- Quantity and quality dosing control
- Watertightness control
- Centrifugal Resistance Control

Each case includes a brochure with recommendations of use.

Expiry date our tubes, anticoagulants and other

- Serum tubes (granules and gel) 24 months
- Serotub Glucose 12 months
- Lithium heparin 24 months
- Iodoacetate heparin 13 months
- Edta 24 months
- Citrate for coagulation 15 months
- Anticoagulants in containers 24 months
- Thrombocyte count and osmotic brittleness 24 months
- Reticulocyte vital staining 24 months



100% Traceability

Our blood collection tubes are individually identified with its code, LOT number and expiry date, so the traceability from its manufacture to the final consumer is guaranteed. **Raw materials traceability. Process traceability. Final product traceability.**

We manufacture our blood collection tubes by following:

- Directive **98/79/EC** "In vitro" diagnostic medical devices which will be replaced by EU Regulation No. 2017/746
- **ISO 6710** Single use containers for blood collection
- **UNE-EN ISO 14971** for the Risks Management of Sanitary Products
- **UNE-EN ISO 15223-1** Labelling symbols
- **UNE-EN ISO 13485**, medical devices - quality management systems



Silicone and TPE tourniquet

Product intended for the retention of the blood flow by oppression of a corporal limb for extracting blood samples, differentiate a vein, ...etc.

Silicone tourniquet

Dimensions: 19 mm wide, 0.8 mm thickness.

Non toxic, USP, Class VI, silicone. **Autoclavable.**

TPE tourniquet

Dimensions: 25 mm wide, 0.6 mm thickness and 450 mm length.

Manufactured with TPE, thermoplastic elastomer. Latex-free product, non cytotoxic and non-irritant.



mod.	code	description	dimensions	quantity	weight	volume
	GS-01	silicone	roll of 50 m	1 x 50	0.89	0.003
1	GS-02	silicone	box with 10 bands 0.5 m long each	1	0.11	0.001
2	TQ	TPE	16 cm	1,000	7.00	0.019



Glucose solution for oral administration

Glucose solutions for oral administration, intended for testing diagnostic tests related to glucose metabolism. For diagnostic: Test of Glucose Tolerance in the evaluation of mellitus diabetes and related diseases.

Glucose solutions are ready for use, and they are specially designed as a safe and economical product that allows overhead standardize testing in studies of glucose metabolism. Its formulation and organoleptic characteristics (pleasant orange or lemon flavor) gives them an excellent acceptance and tolerance by the patient ingesting even fasting, avoiding the frequent cases of vomiting caused by conventional preparations.

code	presentation	case quantity	case weight	case volume
986517	Glucorange 75/200	4 x 12	13.40	0.03
986524	Glucorange 75/200	4 x 12	13.40	0.03



Serum glucose serotub

Transparent polypropylene tubes, covered and labelled with detail of lot number, expiration and volume. With ergonomic cap in inert polyethylene.

Tubes treated with inert additive for rapid clot retraction and serum separation. As well as inert granules, rounded to avoid possible lesions in erythrocytes at the time of centrifugation and its consequent risk of haemolysis. These granules act as a barrier that, without being airtight (as in the case of the gel), ensures comfortable pipetting or decanting of serum.

They allow most biochemical, glucose and creatinine measurements to be performed in a single tube, except for CPK and lithium, thus saving the use of two tubes, one for routine tests and the other for glucose.

Presentation: in black bags due to the photosensitivity of the product

Store at room temperature.

It is supplied in plastic racks.

Expiration: 12 months.

code	description	case quantity	case weight	case volume	pallet quantity
600602	13 x 75 for 4 ml blood	12 x 100	4.92	0.033	42

Ask for minimum quantity and delivery time for tube 16 x 100. 10 ml blood.



Citrate for coagulation

Made of clear polypropylene, supplied capped and labeled.

Our sodium citrate, 3.8% or 3.2% concentration, buffered and sterile has a ratio citrate: blood 1:9 and is highly recommended for coagulation tests. Buffered to pH. According to the prevailing rules, this liquid anticoagulant permits to determine the prothrombin time (Quick) **up to 12 hours after sample collection.**

The cap is not only easy-to-use but also assures a watertight closing; allowing a comfortable and reliable capping.

A volume indication mark, lot number and expiry date on the label of each tube, allows to assure the traceability of the product.

Tubes are supplied in plastic racks.

Expiration: 15 months.

code	type of coagulant	description	case quantity	case weight	case volume	pallet quantity
601102	buffered to 3.8%	13 x 75 round for 4 ml blood	12 x 100	5.30	0.033	42
601103	buffered to 3.8%	13 x 75 round for 2.5 ml blood	12 x 100	5.30	0.033	42



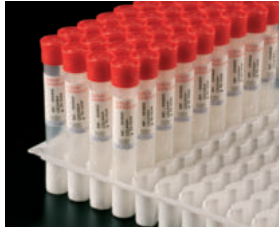

Serum tubes with clot accelerator and gel serum separator

Made of a clear polypropylene, supplied capped and labelled with an inert polyethylene cap.

The tubes are designed and processed to permit a fast serum and blood clot separation.

Each tube contains a special inert additive which accelerates the coagulation, and the result is a **fast clot retraction**.

The coagulation speed is, doubtlessly, much higher than the obtained with the glass tubes or the other existing tubes on the market.

The inert gel is located, after centrifugation, between the clot and the obtained serum and it works as a totally watertight barrier.

The ergonomic features of the cap design results in a very reliable and easy-to-use cap.

On the label of each tube the lot number, expiry date and volume are printed.

Supplied in plastic racks.
We strongly recommend its usage for biochemistry, routine tests, special biochemistry, markers, hormones, immunology (tube without anticoagulants).

Expiry time in 24 months.



code	description	case quantity	case weight	case volume	pallet quantity
600801	13 x 75 round for 4 ml	12 x 100	5.40	0.030	48
600800	16 x 100 round for 9 ml	6 x 120	6.00	0.040	36

Serum tubes with clot accelerator and gel serum separation

Clotting speed increased: with our the tubes processed with gel serum separator and accelerator we improve the clotting speed achieving a 20-25% advantage over glass tubes. The serum is obtained after 15 minutes, depending on the particular working conditions.

Serum volume increased: The volume obtained is higher than the obtained with granules tubes or glass tubes, achieving an advantage around 20%. The gel serum separator tube is the preferred option when analysis requires maximum serum yield from the blood sample.



Recommended in case the objective is to obtain larger serum volume.

Note: Before using, the gel serum separator remains at the bottom, even when the tube is bent.

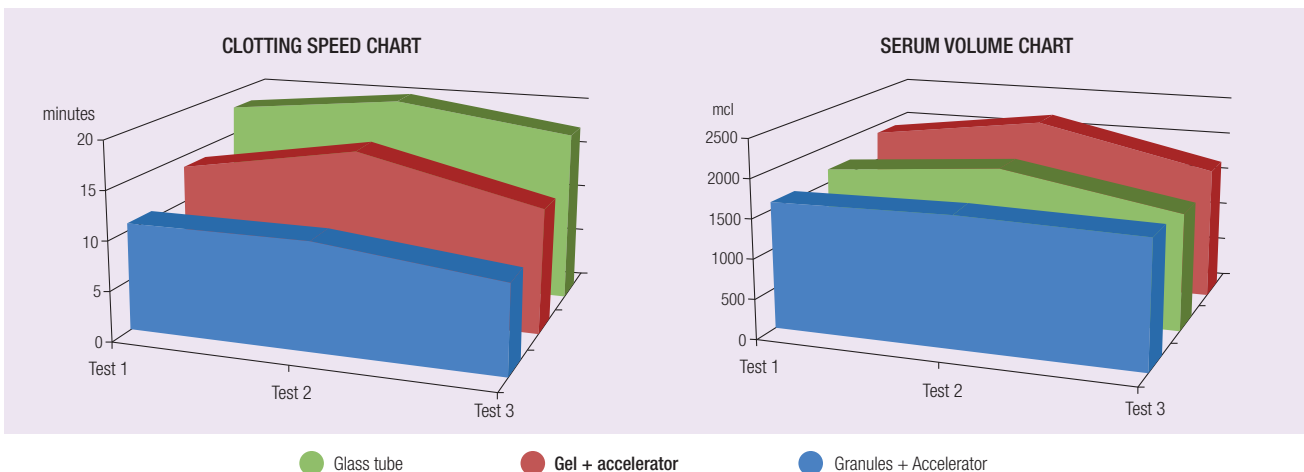

Serum tubes with clot accelerator and granule serum separator

Made of a clear polypropylene, supplied capped and labeled with an inert polyethylene cap.

The tubes are designed and processed to permit a **fast serum and blood clot separation**.

Each tube contains a special inert additive which accelerates the coagulation, and the result is a fast clot retraction. The coagulation speed is much higher than the obtained with the glass tubes or the other existing tubes on the market. Allows the obtention of serum in 12 min.

The inert **granules are rounded** to avoid cellular lesions during centrifugation and minimize the risk of haemolysis. These granules are located between the clot and the separated serum working as a retaining wall. It assures a comfortable pipette action or serum decanting. (It isn't a watertight barrier).

The ergonomic features of the cap design results in a very reliable and easy-to-use cap.

On the label of each tube the lot number, expiry date and volume are printed.

Expiry time in 24 months.



code	description	case quantity	case weight	case volume	pallet quantity
600400	13 x 75 round for 4 ml	2 x 1.000	7.90	0.045	32
600300	16 x 100 round for 9 ml	2 x 500	6.10	0.045	32
707094*	bottle of 750 g with separator granules	20	17.50	0.045	40

* Product without CE mark



Serum tubes with clot accelerator and granules

Clotting speed increased: with our the tubes processed with granules and accelerator we achieve a clotting speed higher than the obtained not only with glass tubes but also with gel tubes. The advantage achieved is around 40-50% over glass tubes. Serum can be obtained starting from 12 minutes, depending on working conditions.

Serum volume increased: The volume obtained is a little higher than the obtained with glass tubes but fewer than the obtained with gel serum separator tubes.



Due to its effectiveness and low price this product is highly recommendable for all routine serum tests.

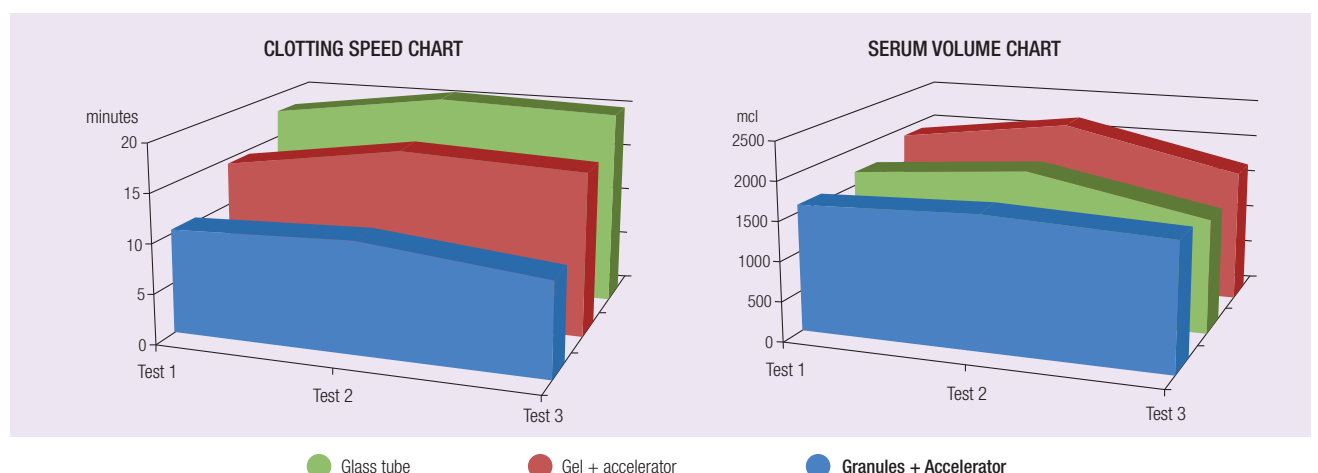

Lithium heparin tubes

Made of a clear polypropylene, supplied capped and labeled, indicating **filling line, lot number, and expiry date.**

The anticoagulant pulverization inside the tube optimizes the mixture and avoids the unnecessary blood dilution.

The anticoagulant mechanism is the inhibition of the thrombin action.

Supplied in plastic racks.

Type of coagulant: **spray.**

Expiry time in 24 months.

code	description	case quantity	case weight	case volume	pallet quantity
601802	13 x 75 round for 4 ml blood	12 x 100	4.10	0.033	42
601803	13 x 75 round for 2.5 ml blood	12 x 100	4.10	0.033	42



Iodoacetate lithium + heparin lithium tubes

Made of a clear polypropylene, supplied capped and labeled. On the label of each tube a fill line indicates the level of blood required, as well is printed **the lot number and expiry date.**

The anticoagulant and preservative pulverization inside the tube optimizes the mixture and avoids the unnecessary blood dilution.

The blend anticoagulant-glucose preservative is ideal for biochemical tests, so it's possible to determine most of the biochemical parameters with only one tube and preserve the product stable for 4 days. It is recommended to maintain the tubes in a dark and cool place (at room temperature).

The tubes are packed in black bags in order to maintain them out of the light because the iodum is photosensitive.

Supplied in plastic racks.

Type of coagulant: **liquid.**

Expiry time in 24 months.

code	description	case quantity	case weight	case volume	pallet quantity
602002	13 x 75 round for 4 ml blood	12 x 100	4.40	0.033	42
602003	13 x 75 round for 2.5 ml blood	12 x 100	4.30	0.033	42



Edta: tripotassium

Made of clear polypropylene, supplied capped and labeled.
 Tetraceticetilendiamin acid, a tripotassium salt, works as an anticoagulant thanks to its capacity to fix the blood calcium. Because the anticoagulant is pulverized, it allows a mixture with the blood almost immediate.
 The quantity of additive is very small so there are no dilution mistakes (this may occur in the tubes with big additive liquid solution volumes). There is no risk of anticoagulant loss when uncapping because it is adhered to the tube walls.
 The cap shape, both internal and external design, assures a comfortable and reliable capping.

A volume indication mark, lot number and expiry date on the label of each tube, allows to assure the traceability of the product.

Supplied in plastic racks. Type of coagulant: **spray**.

Expiry time in 24 months.



code	description	case quantity	case weight	case volume	pallet quantity
601613	15 x 50 flat for 2.5 ml blood	10 x 120	4.50	0.035	36
601603	13 x 75 round for 2.5 ml blood	12 x 100	4.10	0.033	42
601702	13 x 75 round for 4 ml blood	12 x 100	4.14	0.033	42



Edta: tripotassium. Rubber cap

Tubes made of clear polypropylene, supplied capped and labeled. Mauve, pierceable (but not pierced) and plugged cap made of thermoplastic rubber.
 Suitable for hematological automatic machines.

The label indicates **code, volume, lot number and expiry date**, assuring total traceability.

Tubes supplied in trays of 100 units.

Type of coagulant: **liquid**.

Expiry time in 24 months.



code	description	case quantity	case weight	case volume	pallet quantity
1 611604	13 x 80 for 3 ml blood	8 x 100	3.00	0.030	50
2 611603	13 x 75 for 3 ml blood	20 x 50	4.43	0.034	36

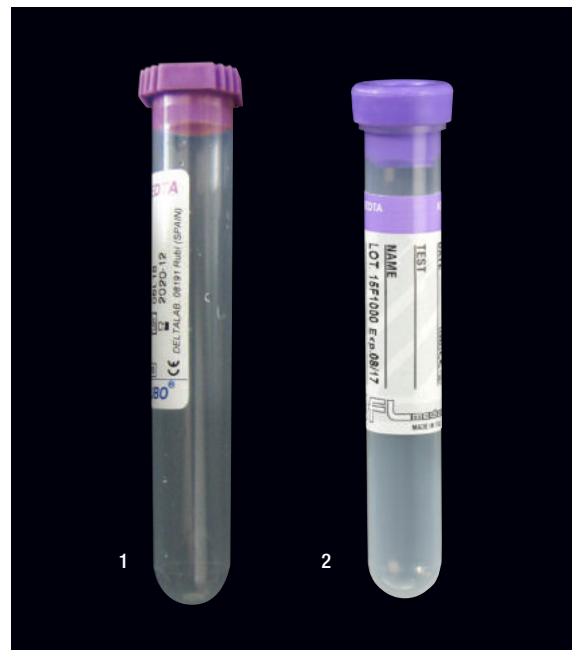

Blood-plasma. Edta tubes: dipotassium

Made of clear polypropylene, supplied capped and labeled.
 Tetraaceticetilendiamin acid, a dipotassium salt, works as an anticoagulant thanks to its capacity to fix the blood calcium. Because the anticoagulant is pulverized, it allows a mixture with the blood almost immediate. The quantity of additive is very small so there are no dilution mistakes (this may occur in the tubes with big additive liquid solution volumes). There is no risk of anticoagulant loss when uncapping because it is adhered to the tube walls. The cap shape, both internal and external shape, assures a comfortable and reliable capping. **A volume indication mark, lot number and expiry date on the label of each tube, allows to assure the traceability of the product.**

Supplied in plastic racks. Type of coagulant: **spray**.

Expiry time in 24 months.



code	description	case quantity	case weight	case volume	pallet quantity
601402	13 x 75 round for 4 ml blood	12 x 100	4.10	0.033	42
601412	15 x 50 flat for 4 ml blood	10 x 120	4.98	0.033	36
601413	15 x 50 flat for 2.5 ml blood	10 x 120	4.26	0.033	36



E.S.R. citrate tube

Capped and labeled transparent polypropylene tubes.
 Filled with 3.8% sodium citrate (anticoagulant).
 The citrate: blood ratio (according to the Westergren method) is 1:4, so the tubes contain 0.4 ml of stable 3.8% sodium citrate solution.
 The printed fill line indicates 2.0 ml so 1.6 ml of blood will be added.
 The cap design results in a comfortable and reliable handling, specially because it is possible working with gloves without slipping.
Volume fill line, expiry date and batch number are printed on the label; so the product traceability is guaranteed.
 Supplied in 100 units plastic racks.

Expiry time in 15 months.



code	description	case quantity	case weight	case volume
601006	round tube 13 x 75 mm for 2 ml (1.6 ml of blood)	12 x 100	4.87	0.033

Pallet quantity: 42 cases.



Sedirate micro system

System for the determination of the erythrocyte sedimentation rate. Specially recommended for **Paediatrics**. The system consists of a tube and a pipette. The tube includes a pierceable and re-sealable stopper. Filled with 0.08 ml of trisodic citrate 0.106 M for 0.32 ml of blood according to standards of Westergren standard method. The pipette of pressure filling has an inner diameter of 1.25 mm and is graduated. Once blood and citrate are mixed together, introduce the pipette into the tube (without removing the stopper). The blood will automatically reach the 0 level. The results obtained are comparable to those obtained with the standard method (macro).

Expiry time in 12 months.

Comparison of the ESR reading obtained with the Micro system and standard type

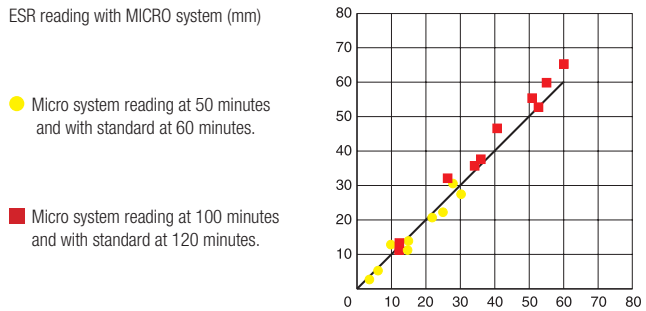

code	description	case quantity	case weight	case volume
27	set pipette + tube	400	3.28	0.029



E.S.R. semi micro system TAKIVES with self-levelling system

Pipette graduated from 0 to 160 mm, with a total length of 200 mm and an inner diameter of 2.5 mm, according to the Westergren Method.

The **system accepts a total volume of 1 ml.**

The plunger must be drawn up manually up to a limit inside the pipette to ensure an adequate volume of blood-citrate blend.

Two tubes available, both made of high transparency polypropylene:

Code **601006**: for 2 ml of total volume (1.6 ml of blood); with a polyethylene cap that shall be taken off before inserting the pipette.

Expiry date: 15 months.

Take a reading after 1 hour and the second after 2 hours

E.S.R. with self-levelling system

Westergren method. *1st reading at 1 hour and 2nd reading at 2 hours.*

Code 29

Consists of a polystyrene pipette with self-filling system using a plunger suitable for 12 mm or 13 mm O tubes. Graduated from 0 to 180 mm. 1.25 ml blood-citrate mixture is enough for determination.

Expiry date: 15 months.

Code 132832

Consists of a Soda glass pipette up to 180 ml, in white screen printed, with a piston in low density polyethylene incorporated.

Measures: 210 x 4.5 mm. **Expiry date:** 60 months.

Code 601006

Ultra-clear polypropylene tube and black cap in low density polyethylene. Inert Labelling with packaging date, code printing, lot number and expiration date.

Expiry date: 15 months.

Code 1361

Plastic stand for ten tubes with their respective pipettes. Excellent stability, thanks to its broad base and the metallic counterweight it incorporates.

code	description	case quantity	case weight	case volume
1360	graduated pipette	2 x 500	3.35	0.008
1361*	stand for 10 pipettes	5	3.20	0.020
601006	tube 13 x 75 mm with sterile citrate for 2 ml (1.6 ml of blood)	12 x 100	4.87	0.033
1164	tube 12 x 55 with citrate pierceable cap	10 x 100	3.02	0.020

* Product without **CE** mark

code	description	case quantity	case weight	case volume
29	E.S.R. pipette, 230 mm long graduated up to 180 mm	3 x 200	2.60	0.027
NEW 132832	glass pipette SVG 180mm + plunger	4 x 500	3.15	0.0026
601006	tube 13 x 75 mm with sterile citrate for 2 ml (1.6 ml of blood)	12 x 100	4.87	0.033
1361*	stand for 10 pipettes	5	3.20	0.020

* Product without **CE** mark

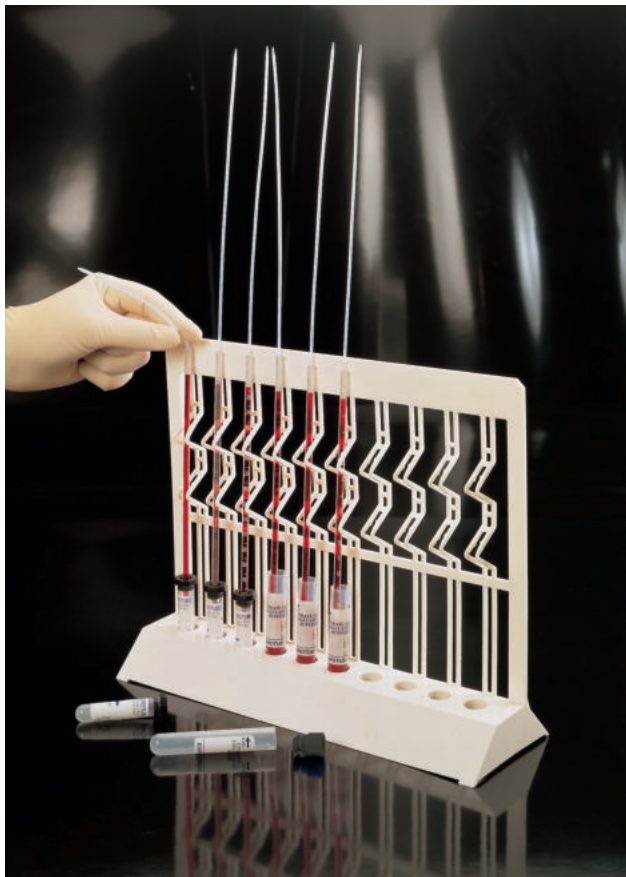



Mailing container

Mailing container with safety screw blue cap, both manufactured in polyethylene. Leak proof.

Dimensions uncapped 117 x 30 mm. Ideal for 10 ml tubes.
The tube includes a piece of absorbent paper to prevent any leakage.
Container and cap are sold separately.

External mouth diameter 24,5 mm, internal: 21 mm.

code	description	case quantity	case weight	case volume
401301	mailing container	500	7.70	0.090
401302	screw cap	500	1.90	0.095

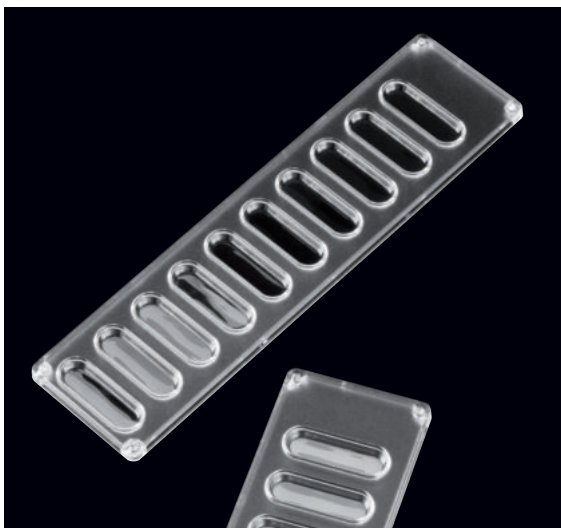

Blood group test plate

Made of ultra clear polystyrene.
Features 10 numbered wells.
Stackable.

Dimensions: 160 x 40 x 6 mm.



code	description	case quantity	case weight	case volume
128030	blood group plate	25 x 10	3.70	0.014



Syringes

3-piece syringes formed by body, plunger and sealing gasket.
Transparent PP cylindrical body, with support fins and provided with a ring Safety that prevents accidental exit of the piston.
With an indelible graduated scale according to the International System of Measurements.

In unitary container, sterilized by ethylene oxide.
Non-pyrogenic and latex free product, PVC and Phthalates.
For version with ajuga, contact the commercial department.



code	description	case quantity	case weight	case volume	volume du carton
JS1	1ml	3C centered luer	32 x 100	13	0.113
JS2	2ml	3C centered luer	30 x 100	13	0.113
JS3	5ml	3C centered luer	24 x 100	15	0.113
JS4	10ml	3C eccentric luer	16 x 100	15.5	0.113
JS5	20ml	3C eccentric luer	16 x 50	14	0.100
JS6	60ml	3C eccentric luer	16 x 25	16	0.120
JS8	60ml	3C catheter	16 x 25	17.00	0.120
JS9	100ml	3C catheter luer adapter	4 x 25	6.5	0.060

Blood collection tubes with pierceable and re-sealable rubber caps

Manufactured from transparent polypropylene. Robust and resistant to breakage. Tubes feature a unique flexible rubber cap which has two cross cuts and is specially designed to reseal automatically after introduction or withdrawal of the sample. This system eliminates the need to remove the stopper when introducing or withdrawing blood samples. Tubes can be used with most manual, semi-automatic and automatic blood sampling machines, and are suitable for transportation by intra hospital pneumatic systems.

Blood collection tubes



code	type	description	expiration months	case quantity	case weight	case volume
620400	serum separator	13 x 80 with granules for 4 ml	36	8 x 100	3.20	0.030
621611	edta tripotassium	16 x 55 skirted for 2.0 ml	24	10 x 100	3.50	0.034
621613	edta tripotassium	13 x 80 for 2.5 ml	24	8 x 100	2.98	0.031

Pallet quantity: 50 cases.

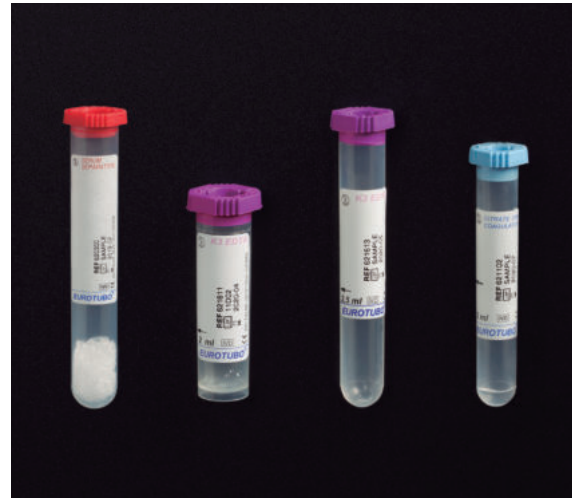

Special pediatrics



See speed sedimentation citrate for pediatrics in the page 80.

code	type	description	expiration months	case quantity	case weight	case volume
620200	serum separator	12 x 55 with granules for 2 ml	36	10 x 100	3.10	0.023
621610	edta tripotassium	12 x 55 for 1 ml	18	10 x 100	2.82	0.024
621101	citrate for coagulation	12 x 55 for 1 ml	15	10 x 100	2.84	0.024

Pallet quantity: 50 cases.



Tubes for small blood volumes

Tubes intended for use by health professionals in clinical analysis laboratories and venous blood sample collection units.

Main use for collection of venous blood sample for blood cell count (cell structures at room temperature remain stable for a period not exceeding 4 hours after extraction)

Others: Obtaining plasma (for biochemical determinations in general except for triglycerides by enzymatic methods, glucose, potassium and calcium)

Recommended in pediatrics or for low blood volumes.

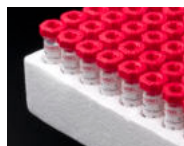

Accessory available under request to the commercial department.



See speed sedimentation citrate for pediatrics in the page 80.

code	type	description	expiration months	case quantity	case weight	case volume
1501118	tripotassium edta	11 x 40 skirted for 1ml	18	10 x 100	2.3 kg	0.017
1501308	coagulation citrate	11 x 40 skirted for 1ml	15	10 x 100	2.3 kg	0.017
1501418	heparin	11 x 40 skirted for 0.8ml	15	10 x 100	2.5 kg	0.017
1501818	serum separator	11 x 40 skirted for 0.8ml	15	10 x 100	2.5 kg	0.017



Common problems in centrifugation

PROBLEM		POSSIBLE CAUSES	REASON FOR MISUSE	SOLUTION
The barrier is not clearly defined	Poor or incomplete serum separation. Barrier is intact and well defined	Incomplete or inhibited coagulation. Non-homogeneous blend of blood and coagulant	The tube was not inverted for 5 times	After tube is filled with blood and capped, gently invert the tube for 5 times
		Early centrifugation, insufficient allowance coagulation time prior to centrifugation	The recommended 30 min. standing time for coagulation was not observed	Wait for 30 min before centrifugation
		Centrifugation xg-setting under appropriate value	The tube was not centrifuged at or above the minimum, appropriate xg-setting	a) Set the centrifuge between 1,000-1,500 xg b) Confirm centrifuge is correctly calibrated
	Barrier is skewed and poorly formed, separation is incomplete	Less centrifugation time than recommended	The tube was not centrifuged for the required time	Centrifuge the tube at the appropriate xg-force for at least 10 min
Refrigerated centrifuge		The temperature of the centrifuge was lower than the recommended	a) Keep the centrifuge at a temperature between 24 °C and 26 °C (around 77 °F). b) Thermally insulate the tube and avoid contact with the centrifuge and centrifuge rotor	
Blood tubes fracture during centrifugation		xg-force centrifugation exceeded the tube construction	The tube was subjected to xg-forces exceeding 1,500 xg	Maintain centrifuge at or below 1,500 xg
		Centrifuge not positioned level and/or foreign matter or debris inside the rotor of the centrifuge	a) Shock absorbers or tube stand-off cushions absent. b) The inside of the rotor is not clean	Install shock absorbers or tube stand-off cushions as required. Remove any foreign agent or debris that may be inside the centrifuge
Cell clumps observed within the separation barrier		Incomplete or inhibited coagulation. Non-homogeneous blend of blood and coagulant	The tube was not inverted for 5 times	Invert the tube for 5 times
		Insufficient time before centrifugation	The recommended 30 min standing time for coagulation was not observed	Wait for 30 minutes before centrifugation
		Excessive xg-force centrifugation	The tube was centrifuged at above 1,500 xg	Set the centrifuge at a speed below 1,500 xg
Presence of fibrin in serum		Incomplete or inhibited coagulation. Non-homogeneous blend of blood and coagulant	The tube was not inverted for 5 times	Invert the tube for 5 times
		Early centrifugation, insufficient allowance coagulation time prior to centrifugation	The recommended 30 min standing time for coagulation was not observed	Wait for 30 minutes before centrifugation
Abnormal assay results		Poor serum quality due to haemolysis	Blood subject to aggressive agitation or rough handling	Handle tube with moderation. Invert gently. Never shake severely or agitate the tube
		Excessive xg-force centrifugation	The tube was centrifuged above 1,500 xg	Set the centrifuge to a maximum of 1,500 xg xg-force

Anticoagulants and preservatives in containers

Available in bottles of 15 ml.
 The dosage of one drop (15 ml = 300 drops) is enough for 5 ml of blood.
 Both products have preservatives for stability.
 Code **705000** composition: lithium heparin, phenylmercury acetate and distilled water. Prepared according ISO 6710. Heparin concentration between 12 and 30 µl for each ml of blood.

Expiry date: 24 months.



code	description	case quantity	case weight	case volume
705000	Lithium heparine 15 ml	10	0.29	0.00019

Special techniques

Liquid for thrombocyte count determination:

Due to its optical characteristics it identifies the thrombocyte avoiding confusion with other cells. This reagent also prevents adhesion and aggregation of the thrombocytes. Full instructions are included with the kit.

Test of osmotic brittleness of the erythrocytes:

The test for the erythrocyte osmotic fragility detects the resistance of these cells to haemolysis, in hypotonical solutions with decreasing concentration of sodium chloride.

This set contains 2 complete tests and each one is composed of 12 tubes with stable and buffered solutions. Full instructions are included in the kit.

Expiry date: 24 months.



code	description	case quantity	case weight	case volume
800000	thrombocyte counting kit 1 x 50 tubes	30 kits	5.50	0.045
802000	osmotic brittleness of erythrocytes kit 2 x 12 plus 2 lithium heparine tubes	30 kits	7.50	0.045

Minimum order quantity: 1 kit.

Reticulocyte staining kit

This simple to use kit consists of a tube containing 100 µl of stable buffered bright cresil blue stain which allows the determination of the erythrocyte count. Two to three drops of blood are added directly to the tube and incubated for 10 minutes at room temperature.

The erythrocytes become a pale blue colour making them easy to identify.

Full instructions are included with the kit.

Tube made of polypropylene and cap of polyethylene.

Expiry date: 24 months.



code	description	case quantity	case weight	case volume
801000	reticulocyte count kit (1 x 50 tubes)	30 kits	5.50	0.046

Minimum order quantity: 1 kit.



Colorants pour Hématologie



Please see more information (page 105) about these stains at chapter **Histology, Microscopy and Staining**.



code	description	volume	dangerousness	case quantity	case weight	case volume
Coloration by May Grunwald						
808000	Eosin	250 ml bottle	H225, H331, H311, H301, H370	16	4.80	0.015
808001	Eosin	1,000 ml bottle	H225, H331, H311, H301, H370	12	13.00	0.045
Coloration by Giemsa						
808100	Eosin	250 ml bottle	H225, H331, H311, H301, H370	16	5.16	0.015
808101	Eosin	1,000 ml bottle	H225, H331, H311, H301, H370	12	13.00	0.045
Coloration by Wright						
808200	Eosin	flacon de 250 ml	H225, H331, H311, H301, H370	16	4.43	0.015
805013	fast stain for blood extensions	250 ml containers, Kit with 2 containers of each type		12 Kits	14.95	0.045



Microhaematocrit capillary tubes

Soda neutral glass tubes with a colour-coded print for an easier identification, with sodium heparin (red) or without heparin (blue).

Supplied inside a glass tube with a plastic cap, specifying code, lot and expiry date.

Two lengths available: 70 or 75 mm (± 0,5 mm).

They meet ISO 12772.



code	description	external diameter	volume µl	case quantity	case weight	case volume
7301	75 mm with heparin	1.4-1.7	75	10 x 100	0.36	0.0006
7311	75 mm without heparin	1.4-1.7	75	10 x 100	0.36	0.0006
7401	70 mm with heparin	1.5-1.6	70	10 x 100	0.36	0.0006
7411	70 mm without heparin	1.5-1.6	70	10 x 100	0.36	0.0006

Capillary tubes sealing wax

Vinyl plastic wax, in a numbered (from 1 to 24) plastic holder.

Suitable for all capillary tubes, specially for those that have to be centrifuged, like micro-haematocrit capillary tubes.

Must be preserved in temperatures from 8 °C to 30 °C.

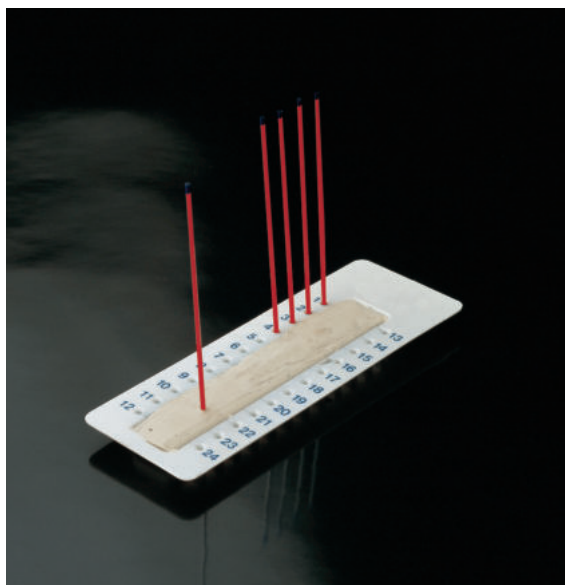

code	description	case quantity	case weight	case volume
7600	sealing wax	3	0.07	0.0002

Spectrophotometer cuvettes

Disposable cuvettes suitable for most of the open spectrophotometers. Homogeneous measures, specially of the surface crossed by the light beam, assuring an optimum transmission level on the whole visible spectral. The material used avoids any possible measurement interference. Due to the strict quality control during the manufacture process, a high reliability is assured. The maximum absorption variations are $\pm 1\%$.

The two sides not crossed by the light beam are ribbed to an easy identification of the cuvette position inside the spectrophotometer measurement chamber, resulting in an easy positioning and removal.

They are supplied in a dust proof, expandable polystyrene box (100 units per box) with lid.

Dimensions: 12.55 x 12.65 x 44.55 mm ($\pm 0,1$ mm).

Light path: 10 mm.

Standard cuvettes

Made of polystyrene for assays in the visible spectral range (340 to 800).

	code	description	case quantity	case weight	case volume
1	302000	4.5 ml macro	5 x 100	1.60	0.020
2	302100	1.5 ml micro	5 x 100	1.60	0.018
3	302400	2.5 ml semimicro	5 x 100	1.40	0.018

Special UV grade cuvettes

Made of UV grade PMMA for accuracy throughout UV/vis range (280 to 800).

Model **303100** with four clear sides is ideal for fluorometry and nephelometry.

	code	description	case quantity	case weight	case volume
4	303100	4.5 ml 4 sides transparent	5 x 100	1.60	0.018
5	303102	4.5 ml macro	5 x 100	1.60	0.018
6	303101	2.5 ml semimicro	5 x 100	1.65	0.015
7	303103	1.5 ml micro	5 x 100	1.82	0.019

Cap

In polyethylene.

Suitable for the macro cuvettes, 4.5 ml (**302000**, **303100**, and **303102**)

	code	description	case quantity	case weight	case volume
8	304000	polyethylene cap	1,000	0.20	0.002

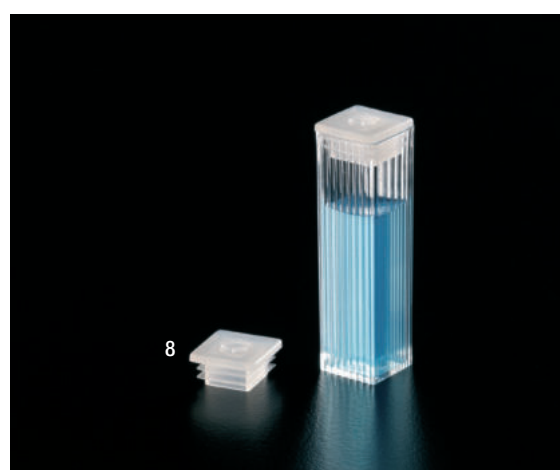
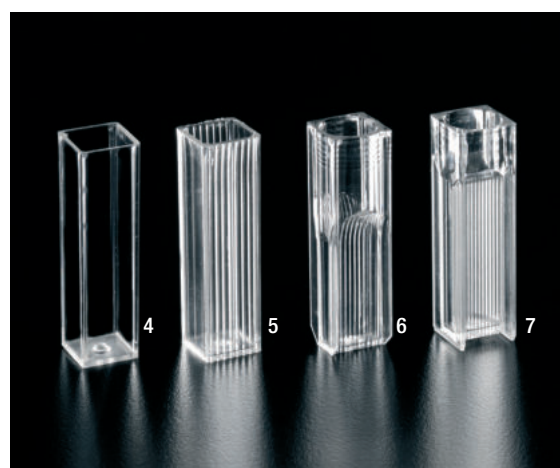

Please see our rack for the spectrophotometer cuvettes, code **M-100**, on chapter **Sample Storage**.

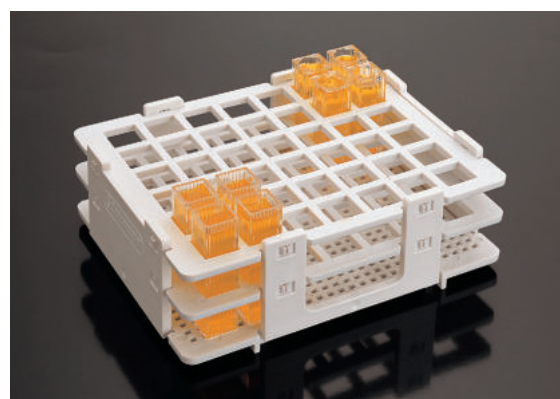

Sample cups

Polystyrene cups, with polyethylene caps. For caps, please contact commercial department.

mod.	code	description	type	Ø ext. mm	h mm	case quantity	case weight	case volume
1	900024	0.50 ml	Gemsaec, Kone Lab 20	13.55	24.50	10 x 1,000	13.82	0.066
2	900023	0.25 ml	Centrifichem	13.70	16.40	14 x 1,000	15.00	0.070
3	900022	1.50 ml	Technicon	13.80	22.60	10 x 1,000	10.60	0.067
4	910022	2.00 ml	Technicon	13.75	24.90	10 x 1,000	10.92	0.068

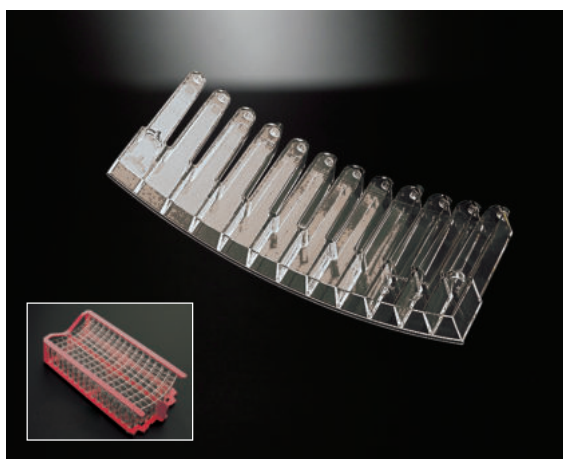
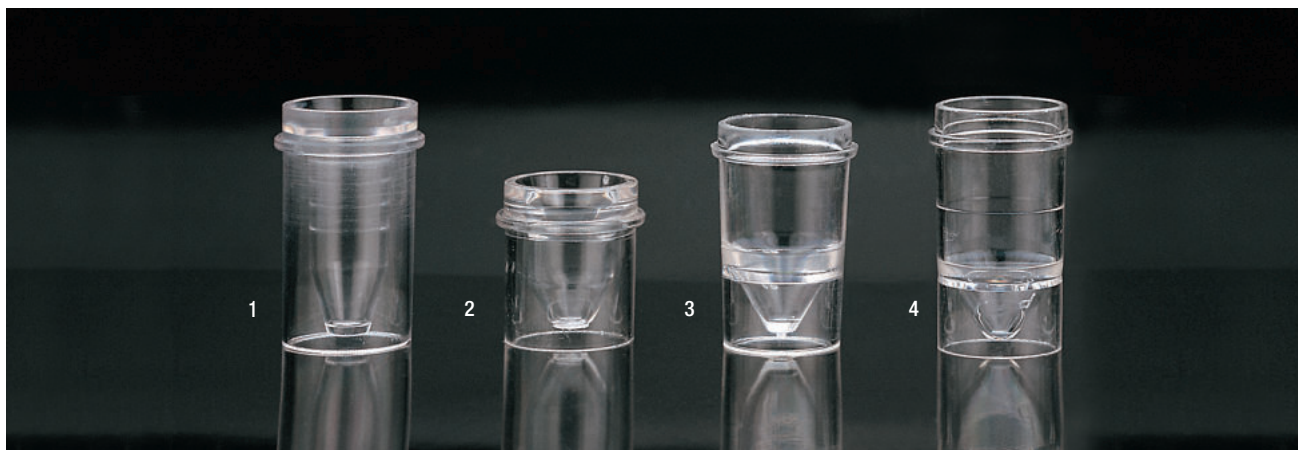

Cobas Mira cuvette segments

Multicuvettes made of PMMA.
 Rack made of polypropylene (colour: red).
 For use on Cobas Mira.
 Light path: 6 mm.
 Complete rack with 15 segments of 12 cuvettes.

code	description	case quantity	case weight	case volume
900019	complete rack: 15 segments of 12 cuvettes	30	9.00	0.041

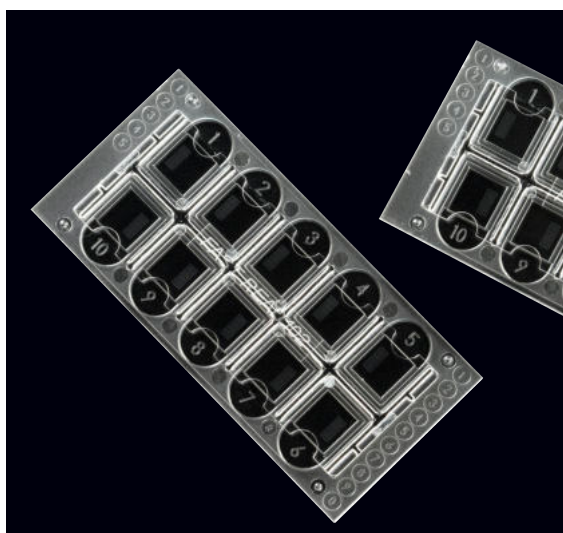

“Fast read” plate for urinary sediment cell count

Disposable plate for determining μL cells in the sample.
 Using this system a smaller number of epithelial cells present in each field can be achieved, reducing the possibility of overlap with other cells. Ensures a more careful and precise result, providing technical staff to determine presence of cellular elements.



code	description	case quantity	case weight	case volume
141746	fast read plate for urinary sediment cell count	100	0.30	0.0008

Sample cups

Cups are made of polystyrene, except code **900008** which is made of HDPE.

Also available under request the 1.5 cup Amelung type with stain ball and the 0.5 cup Sysmex type.

mod.	code	description	type	Ø ext. mm	h mm	case quantity	case weight	case volume
1	900020	2.50 ml	Hitachi	16.75	38.0	6 x 1,000	11.01	0.071
2	900008	0.70 ml	Cobas bio	7.65	35.5	12 x 1,000	8.40	0.067
3	910023	4.00 ml	Technicon	16	37.9	6 x 1,000	12.20	0.069
4	910026	0.5 ml (0.8 ml total volume)	Sysmex	10 / 7.5 (± 0.2)	30	10 x 2,000	11.02	0.061

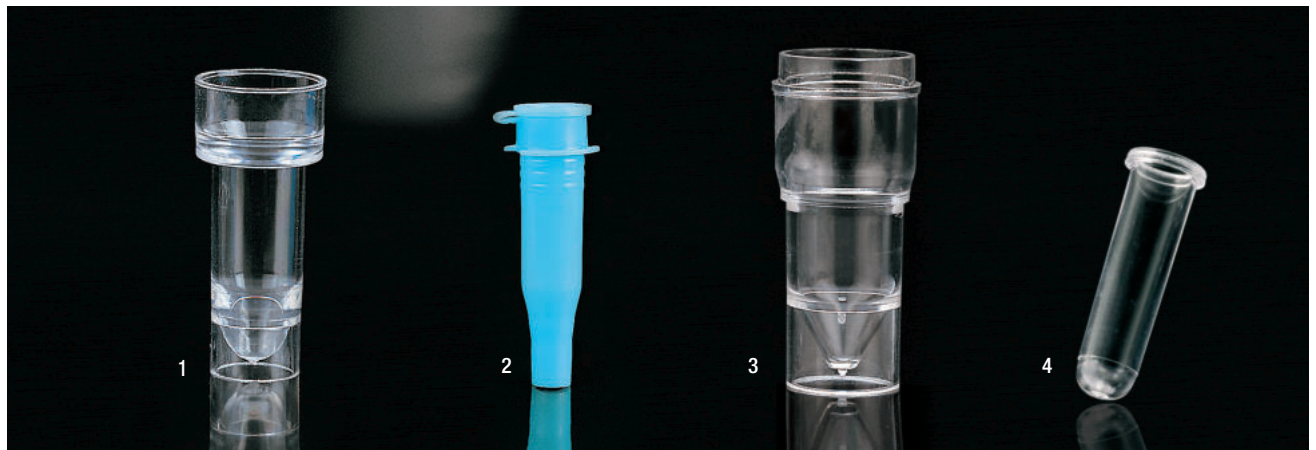

Scintillation vials

Single use vials made of high density polyethylene to minimize solvent losses.

Screw caps made of polypropylene ensure a leakproof seal.

Compatible with most liquid scintillation counters available on the market.

2 models available: code **900100**, standard volume 20 ml, and code **900101**, volume 4 ml, designed for insertion in the 20 ml vial so as to minimize the volume of scintillation liquid.

Dimensions:

Vial 20 ml: 26.5 x 58.5 mm (Ø x h)

Minivial 4 ml: 13.71 x 53.15 mm (Ø x h).

code	description	case quantity	case weight	case volume
900100	scintillation vial (20 ml)	1,000	7.90	0.069
900101	minivial (4 ml) for the above vial	2,000	5.90	0.041

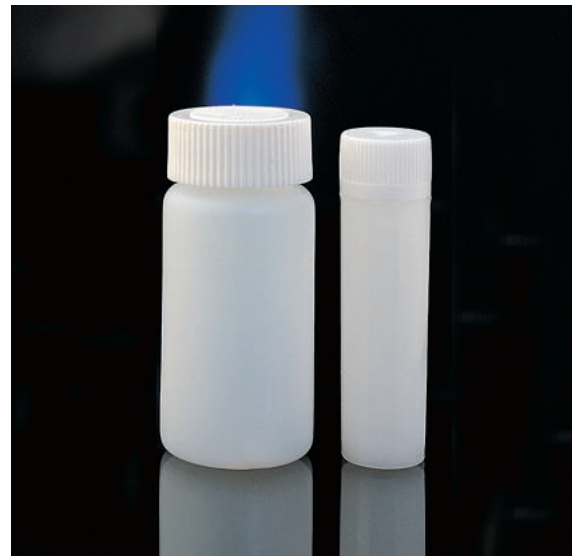

Coulter counter cups

Coulter counter cups: single use polystyrene cups suitable for any Coulter.

Two models available, with or without lid. Volume: 20 ml.

Dimensions: 30 x 56 mm (Ø x h).

code	description	case quantity	case weight	case volume
200103	coulter counter cup with lid	1,000	7.80	0.090



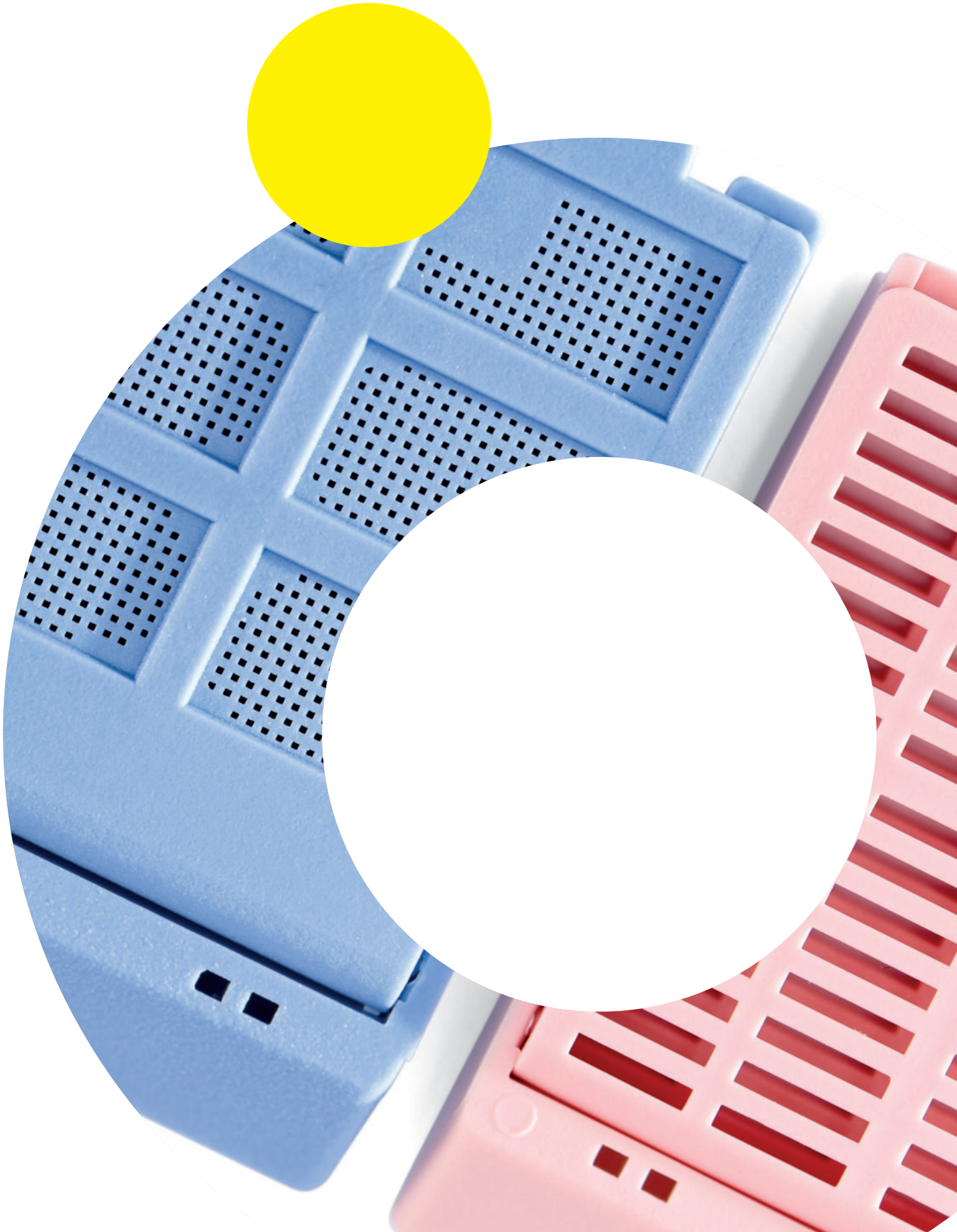



HISTOLOGY, MICROSCOPY AND STAINING

 deltalab



Polyethylene wide mouth jars with lid and insert plug

High density Polyethylene jars with screw cap and insert plug. Jars and plugs are natural translucent; lids are black. Upon request, jars can be supplied individually wrapped for a minimum order of 3 cases for each code, and sterile for a minimum order of 6 cases, for each code.

code	capacity ml	Ø neck mm	Ø base mm	height mm	alimentary use	case quantity	case weight	case volume
202811	30	25	32	53		100	1.00	0.011
202810	60	38	52	48		200	3.90	0.045
202808	90	51	60	51	✓	150	3.90	0.045
202809	125	51	60	62	✓	200	6.00	0.082
202801	170	51	60	80		160	6.46	0.082
202802	250	54	67	100	✓	125	4.85	0.078
202814	400	60	74	124		130	8.00	0.140
202803	500	67	80	131	✓	120	7.70	0.140
202821	500	86	103	93	✓	95	8.44	0.140
202813	750	86	103	127	✓	75	4.56	0.152
202818	1,000	86	103	157	✓	50	5.43	0.140



See more capacities on pages 276-277



Jars with lid

Body and lid in white **autoclavable** polypropylene. Self sealing security lid. Made with materials suitable for alimentary use. Code **241014** embodies a plastic handle. Jars are supplied uncapped.



code	nominal capacity ml	Ø int. mouth x Ø base x height mm	weight g	case quantity	case weight	case volume	casses pallet
241010	250	84 x 79 x 61	13	150	3.04	0.042	32
241011	550	107 x 98 x 79	24	250	5.01	0.103	16
241013	1,000	107 x 94 x 144	36	150	7.31	0.082	20
241014	1,560	135 x 118 x 138	48	150	4.42	0.130	16
241015	2,000	163 x 144 x 156	75	48	5.37	0.075	24



Tamper evident, buckets with lid

Disposable containers made of **autoclavable** polypropylene. Include tight fitting and leakproof lids. All models include a sturdy and convenient white plastic handle for easier carrying. Buckets are supplied with lid apart. Made with materials suitable for alimentary use.



code	capacity l	Ø int. mouth mm	height mm	body weight g	case quantity	case weight	case volume	casses per pallet
222802	3	184.00	138.00	105.00	80	9.00	0.140	16
222803	4.5	210.00	156.00	134.00	48	10.46	0.130	16
222804	5.6	211.00	194.00	152.00	45	10.79	0.140	16
222805	10.6	251.00	263.00	314.00	20	8.39	0.140	16

EUROTUBO® Leak proof screw cap containers

Specially designed for histology, they are provided with double internal security closure. Manufactured in translucent polypropylene with polyethylene ribbed yellow cap. They have moulded graduations in increments of 50 ml, and a ring in the upper part of the container that prevents dripping when decanting liquids. Its leakproof closure makes them ideal for liquid (including alcohols) or solid sample storage.

They meet the standard UNE-EN 14401. Rigid plastic containers. Methods to test the effectiveness of closures.

Supplied uncapped. Check with the commercial department for other colors.



mod.	code	graduated capacity (ml)	maximim capacity (ml)	max. recommended capacity (ml)	external mouth Ø mm	height mm	case quantity	case weight	case volume	cases per pallet
1	202845	150	280	200	89	57	100	4.67	0.046	32
2	202846	350	500	400	90	110	200	10.80	0.082	20
3	202847	700	1,000	800	111	139	100	10.97	0.096	16



Security screw cap containers

Ultra clear polypropylene containers with yellow polyethylene cap. Watertight closure: the cap, with an innovative shape, has a double closure. Graduated Container.

The base and the cap are ribbed so the handling with gloves is comfortable and reliable.

There is a ring in the upper part of the body, in order to avoid the dripping in case of liquid decanting.

Six different capacities from 20 to 120 ml.

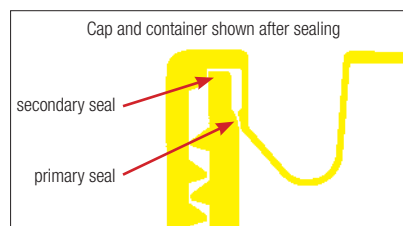

Find more information about this product on chapter **Containers. Sampling**





Paraffin

It has a low dimethylsulphoxyde (DMSO) content and a quick penetration of tissues for 2 micron cuts.

Melting point: **56/58 °C**. Can be used with usual solvents.

Ideal for histology.



code	description	case quantity	case weight	case volume
440139	Paraplast Plus® - 1 kg bag	8 x 1Kg	8.50	0.023
440139D	Pure parafine with DMSO	8 x 1Kg	9.0	0.025

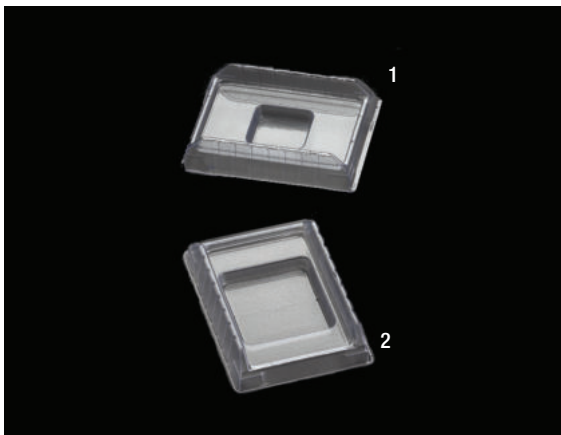

Histology mould

Single use clear polypropylene mould.

The smooth interior ensures the paraffin does not adhere to the mould. The special material used ensures excellent thermal exchange. Available in various sizes.

External dimensions: 50 x 37.2 x 12 mm.

Suitable for the most of cassettes.

mod.	code	well dimensions mm	case quantity	case weight	case volume
1	440131	15 x 15 x 5	1,000	2.20	0.013
2	440132	24 x 24 x 5	1,000	2.20	0.013

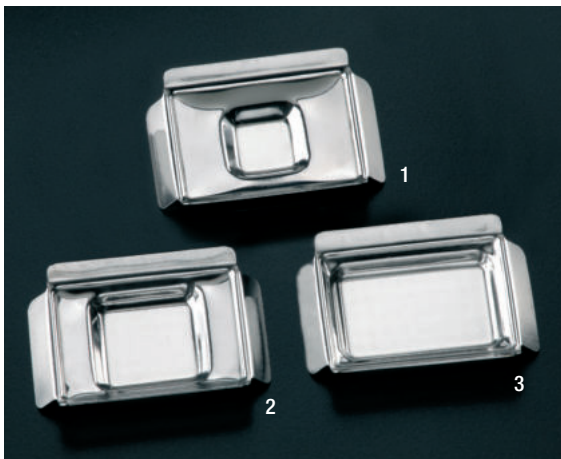

Metal tray histology

Material: stainless steel.

External dimensions: 52 x 35 x 11 mm.

mod.	code	well dimensions mm	case quantity	case weight	case volume
1	192932	15 x 15 x 7	10	0.09	0.0002
-	192933	24 x 24 x 7	10	0.09	0.0002
2	192934	30 x 24 x 7	10	0.09	0.0002
3	192935	37 x 24 x 7	10	0.09	0.0002

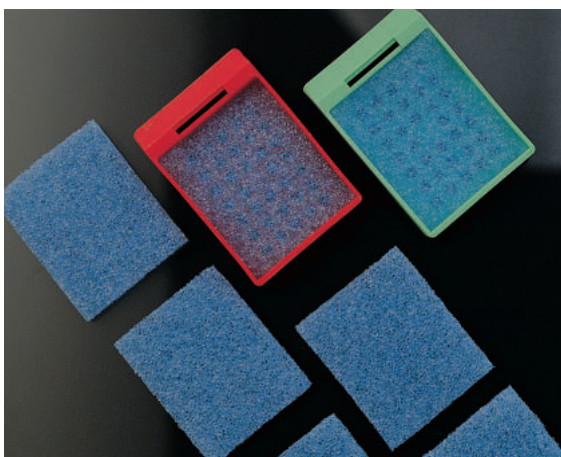

Tissue embedding sponge

Foam sponge, very useful for small specimens in biopsy tests.

Fits standard cassettes.

Avoids sample loss though drain holes when sample is processed.

Does not affect paraffin drainage.

code	dimensions mm	colour	case quantity	case weight	case volume
192922.04	32 x 26 x 3	blue	500	0.08	0.003

Biopsy Bags

Used to hold small biopsy and histological specimens during processing. Manufactured from solvent resistant Polyester, effectively prevent the deformation. Thin mesh (0.2x0.2 mm) provides excellent fluid exchange and avoids small sample loss. Convenient peel-open bag allows for placing and removing specimen rapidly.

HOW TO USE

1. Put the biopsy in the bag and fold its end
2. Place it the cassette and enclose to process as a usual processing
3. Extract the bag from the cassette
4. Open it with care extending the edges
5. Extract the sample for embedding in paraffin



code	colour	case quantity	case weight	case volume
192950	45 x 75	10 x 100	0.2	0.0025
192951	75 x 95	5 x 100	0.3	0.0020
192952	30 x 45	5 x 200	0.17	0.0010

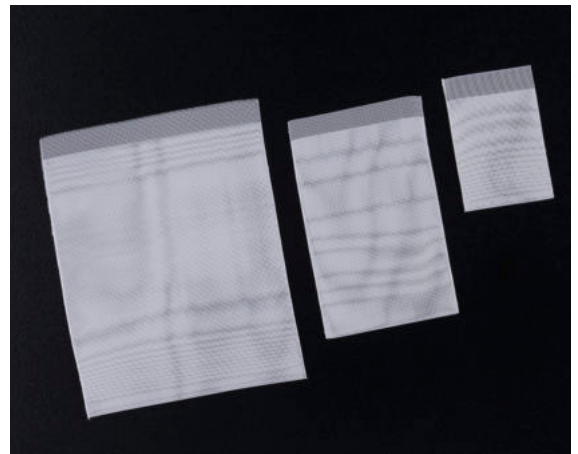

Cassettes without lid

Made of polyacetylene.
With 34 round holes of 2 mm Ø.
Resistant to the solvents used in histological processes.
It is possible to write on them.
External dimensions: 40 x 28 x 6 mm.

code	colour	case quantity	case weight	case volume
440141	white	3 x 1.000	7.00	0.047
440147	green	3 x 1.000	7.00	0.047
440144	pink	3 x 1.000	7.00	0.047
440143	yellow	3 x 1.000	7.00	0.047

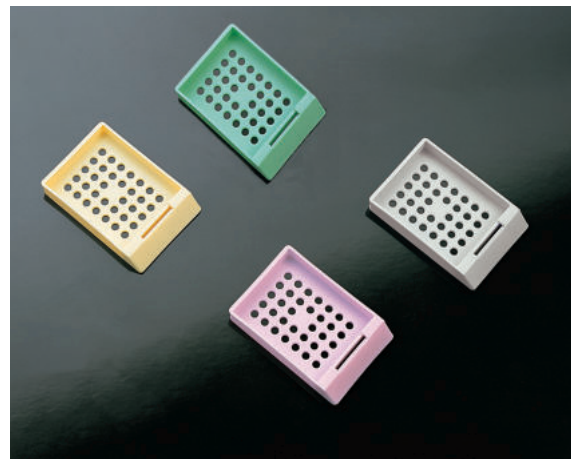

Lids for cassettes

Stainless steel lids. Fit all standard cassettes.
Suitable for **440141** and series.

code	description	case quantity	case weight	case volume
440149	lid for cassettes	25	0.07	0.0006

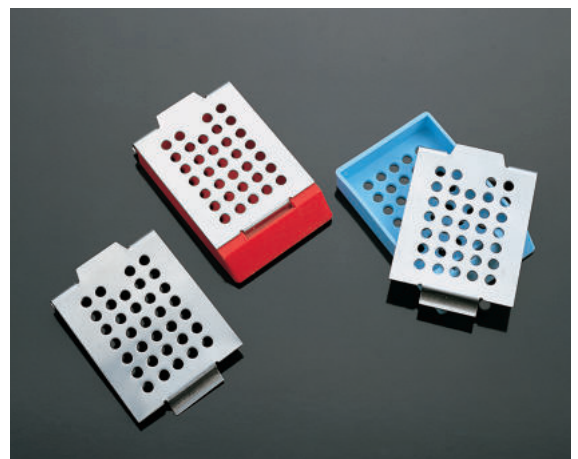

Cassette for biopsy 6 compartments

Material: polyacetylene. Designed for small biopsies, each cassette has six individual cells to hold six samples.
Each cell is 7 x 12 mm. The lid allows multiple opening and closing.
A frosted area allows writing on the cassette.
Each cassette has near 3,000 micro holes of 0.26 mm diameter.

code	colour	case quantity	case weight	case volume
44240	pink	4 x 250	5.20	0.026
44245	blue	4 x 250	5.20	0.026

Ask for minimum quantity and delivery time of other colours.

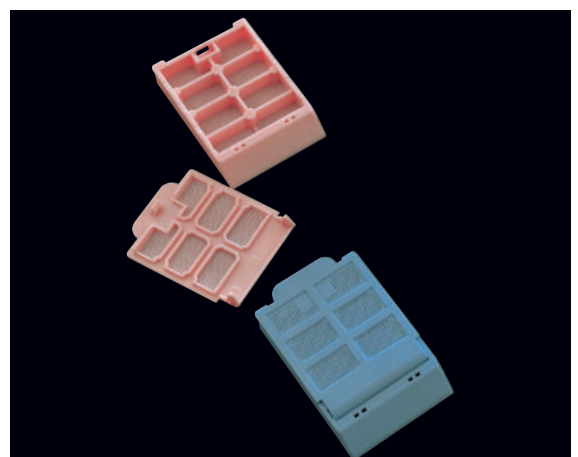



Cassettes for tissue

Made of acetal polymer. With an integral lid.
Hand and automatic cassettes.
 Small tab on the lid for easy opening and locking.

code	colour	case quantity	case weight	case volume
554141	white	4 x 500	7.90	0.064
554147	green	4 x 500	7.58	0.064
554140	pink	4 x 500	7.58	0.064
554148	blue	4 x 500	7.58	0.064

Ask for minimum quantity and delivery time for other colours.



Cassettes for tissue. Histosette I

- Made of polyacetal.
- Air vents allowing more efficient filling with paraffin.
- Safety closure.
- External dimensions: 40 x 28 x 6 mm (with closed lid)
- With one-piece integral lid.
- To lock the cassette, just separate apart the lid, turn it round and lock it into the base of the cassette.
- They may be opened and closed as many times as required.

Writing area at 30°. **Hand cassettes.**
 64 cuts (1 x 5 mm) in base and lid, distributed 16 x 4

code	colour	case quantity	case weight	case volume
454141	white	3 x 500	5.40	0.039
454147	green	3 x 500	5.40	0.039
454140	pink	3 x 500	5.40	0.039
454148	blue	3 x 500	5.40	0.039

Ask for minimum quantity and delivery time for other colours.



Biopsy cassettes. Histosette I

Anterior writing area at a 30° angle. **Cassettes for manual use.**
 Material: Acetal
 Designed to hold biopsy specimens during the embedding process, as well as in a storage file.



code	colour	case quantity	case weight	case volume
454241	white	1,500	5.74	0.037

HOW TO USE

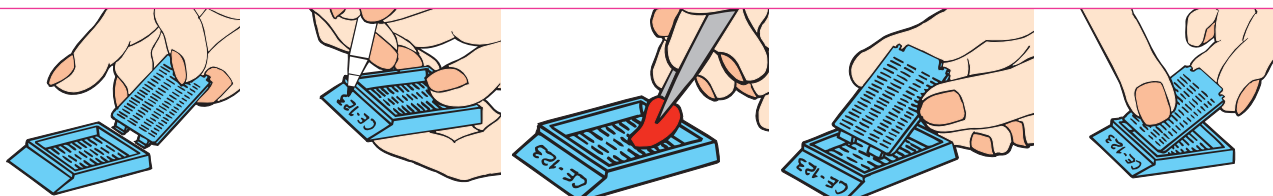

Mega cassettes

Made from polyacetal.
 With an integral lid.
 Designed for larger tissue samples.
 Holes are 1 x 5 mm.
Cassette dimensions: 26 x 40 x 13 mm.

code	colour	case quantity	case weight	case volume
44125	white	500	2.57	0.025

Ask for minimum quantity and delivery time for other colours.

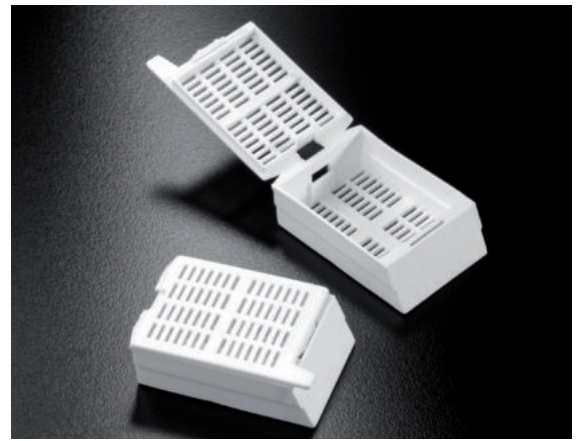

Cassettes for tissue. Histosette II

- Made of polyacetal.
- Hinged lid: can be opened and closed as often as necessary.
- Supplied assembled, saving time and making storage easier.
- External dimensions: 41 x 28 x 6 mm.
- Air vents allowing more efficient filling with paraffin.
- Easy handling with one hand.
- Safety closure (see figure).
- Writing area slanted at a 45° angle, suitable to be used with most labelling instruments.

64 cuts in base and lid. **Hand and automatic cassettes.**
 Cassettes and lids are available: pre-mounted, or with the lid separated in another case.

code	colour	case quantity	case weight	case volume
Cassettes with the lid pre-mounted:				
44140	pink	3 x 500	5.00	0.026
44141	white	3 x 500	5.00	0.026
44143	yellow	3 x 500	5.00	0.026
44145	blue	3 x 500	5.00	0.026
44147	green	3 x 500	5.00	0.026

*2 dispensing boxes with 500 cassettes each plus one box containing 1.000 lids.

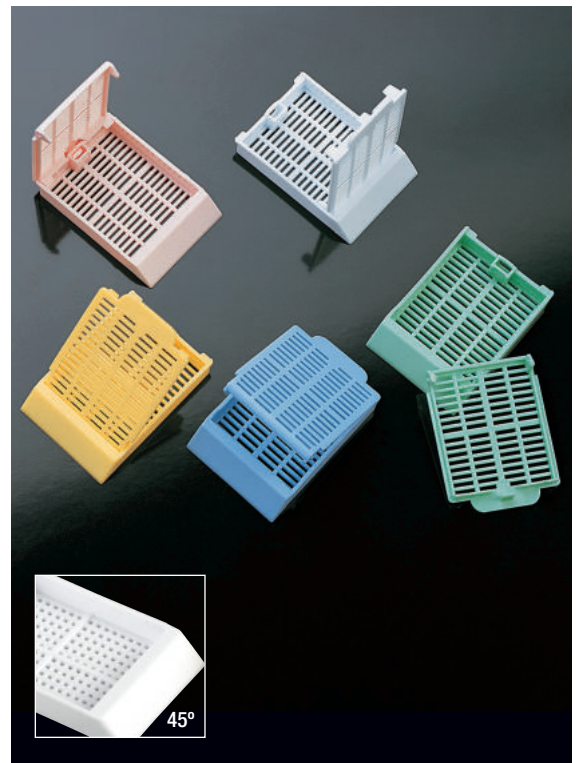

Cassettes for biopsy. Histosette II

Made of acetal polymer. 224 holes. 1 mm square openings to maximize fluid exchange and to ensure proper drainage. **Hand and automatic cassettes.**
 Cassettes and lids are available: pre-mounted, or with the lid separated in another case.



code	colour	case quantity	case weight	case volume
Cassettes with the lid pre-mounted:				
445140	pink	3 x 500	5.20	0.026
445141	white	3 x 500	5.20	0.020
445143	yellow	3 x 500	5.20	0.026
445145	blue	3 x 500	5.20	0.026
445147	green	3 x 500	5.20	0.026

*2 dispensing boxes with 500 cassettes each plus one box containing 1.000 lids.

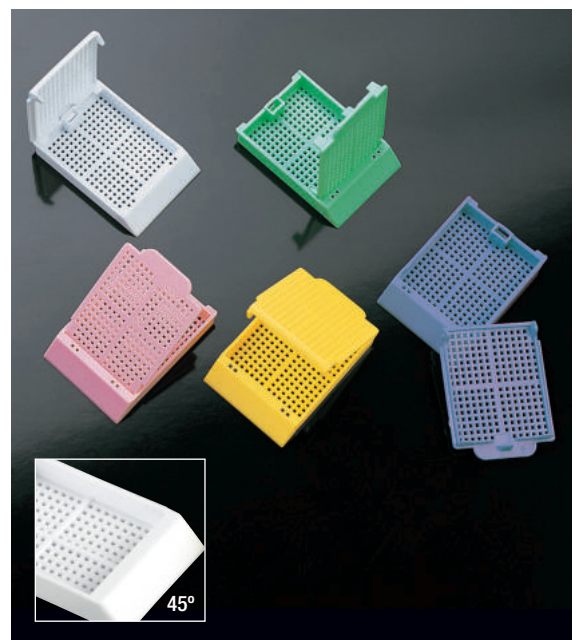

CASSETTES FOR PRINTER

Biopsy and tissue cassettes

Recommended for THERMO printers.

Manufactured in POM, resistant to the chemical action of the solvents used in histology. Available for biopsy, with 0.9mm square holes, and for fabrics, with 0.5x1mm rectangular holes.

With 2 large marking areas on the sides and another on the front, 45°.

The hinge design ensures that the cassette and its lid are always attached even if it is opened and closed frequently, avoiding any loss of the sample.

Supplied in 10 sleeves of 75 cassettes plus 1 zip bag with 750 caps.

For other colors, check with the commercial department.



mod.	code	type	colour	case quantity	case weight	case volume
1	555260	for biopsy	white	750	3.08	0.015
2	555261	for tissue	white	750	2.92	0.015

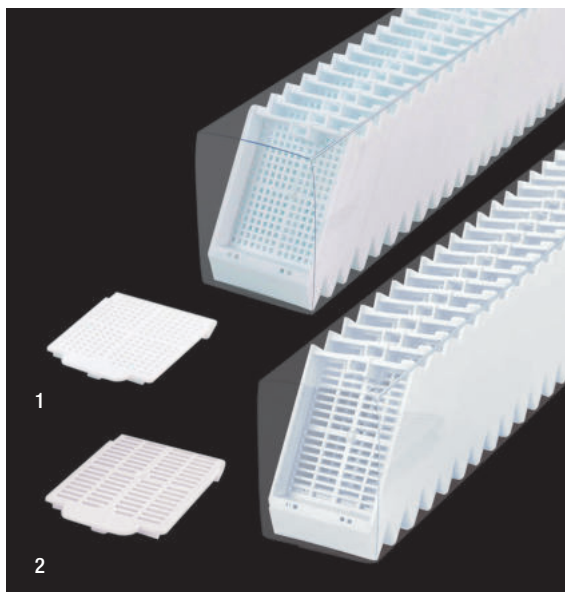

Biopsy and tissue cassettes

Recommended for LEICA Y SAKURA printers.

Manufactured in POM, resistant to the chemical action of the solvents used in histology.

Available for biopsy, with 1.6mm square holes, and for tissues, with 0.5x1mm rectangular holes.

With 2 large marking areas on the sides and another on the front, 35°.

One piece design and snap closure.

Supplied in 25 sleeves of 40 cassettes, with open lid.

For other colors, check with the commercial department.



mod.	code	type	colour	case quantity	case weight	case volume
1	555262	for biopsy	white	1,000	4.15	0.019
2	555263	for tissue	white	1,000	3.71	0.019

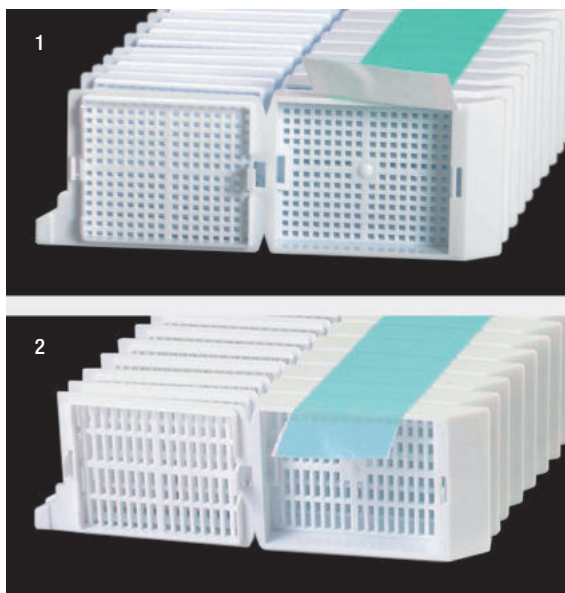

Biopsy and tissue cassettes

Recommended for PRIMERA and SAKURA TISSUE-TEK SMARTWRITE.

Manufactured in POM, resistant to the chemical action of the solvents used in histology. Available for biopsy, with 1.6mm square holes, and for tissues, with 0.5x1mm rectangular holes.

With 2 large marking areas on the sides and another on the front, 35°.

One piece design and snap closure.

Supplied in 25 sleeves of 40 cassettes, with open lid.

For other colors, check with the commercial department.



mod.	code	type	colour	case quantity	case weight	case volume
1	555264	for biopsy	white	1,000	4.26	0.019
2	555265	for tissue	white	1,000	3.96	0.019

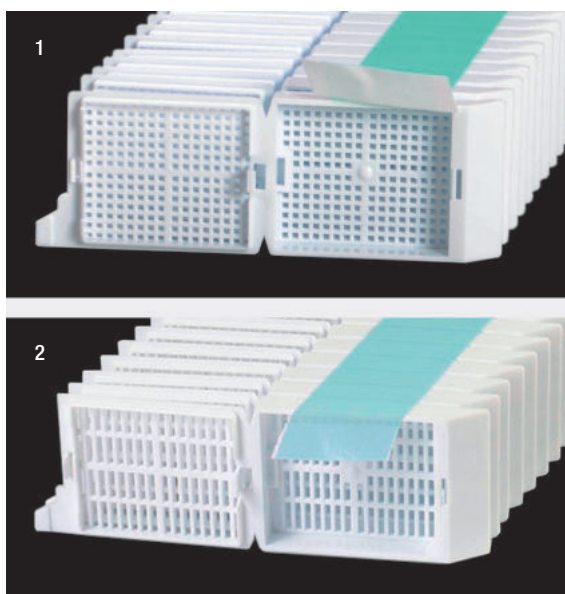

Laboratory storage cabinet

Designed especially for the storage of microscope slides, histology cassettes and embedding rings. Universal models interchangeable with other cabinets on the market. All parts of the cabinet are stackable. Manufactured from enameled metal. Colour grey. You can make up your own composition from one or several of the following elements:

- Modular cassette drawers
- Modular microscope slide drawers
- Top
- Base
- Wheels base

All modules are stackable.



Modular top (1)

code	external dimensions mm			unit weight	unit volume
	height	length	width		
DS51	26	485	480	2.18	0.007

Modular cassette drawers (2)

Cabinet consisting sliding drawers. The cabinet can hold approximately 910 embedding rings.

code	external dimensions mm			unit weight	unit volume
	height	length	width		
DS36	91	485	480	9.56	0.033

Modular microscope slide drawers (3)

Consisting of 14 sliding drawers to hold a total of approximately 5,600 microscope slides of 26 x 76 mm.

code	external dimensions mm			unit weight	unit volume
	height	length	width		
DS10	146	485	480	12.50	0.044

Modular base (4)

To fit all modular cabinets and drawers.

code	external dimensions mm			unit weight	unit volume
	height	length	width		
DS52	76	485	480	1.59	0.019

Modular base with wheels (5)

To fit all modular cabinets and drawers.

code	external dimensions mm			unit weight	unit volume
	height	length	width		
DS63	146	485	480	9.24	0.070

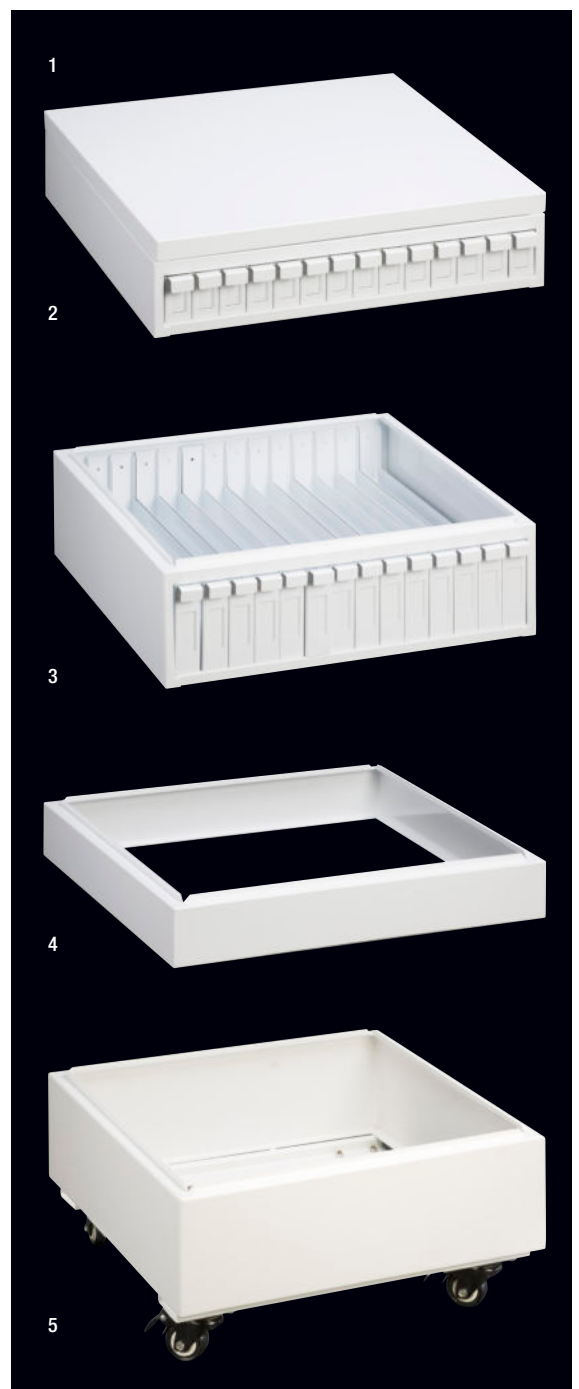



Forceps

Made of polyoxymethylene. Colour: orange.
 Self-sprung forceps with rounded ends.
 Code **19503**, the inner part of the tip is ribbed to enhance sampling. Ribbed for a better handling.
Autoclavable. Flexible.



code	length mm	case quantity	case weight	case volume
19500	115	5	0.23	0.0006
19501	145	5	0.05	0.0001
19503	250	5	0.17	0.0043



Economical storage box

This box, complete with a lid, is specially designed for the storage of histology cassettes.
 Made of heavy-duty cardboard for long term storage.
 Each box stores up to 250 cassettes or 160 embedding rings.

Dimensions: 455 x 235 x 50 mm.

code	description	case quantity	case weight	case volume
DS42	waterproof cardboard	18	5.30	0.130



Modular storage drawers

Made of high impact polystyrene, this set consists of 6 stackable drawers (7 slots per drawer) providing permanent storage and identification of up to 165 embedding rings or 250 cassettes per drawer (total capacity: 1,500 cassettes).

Dimensions: 400 x 230 x 340 mm.
 Front: black colour. Sides: grey.

code	description	case quantity	case weight	case volume
DS40	set of 6 drawers	1	6.00	0.034

EUROTUBO® slides

Standard size: 26 x 76 mm (± 0.2 mm)

Thickness: 1.1 mm (± 0.1 mm)

Clear, **pre-washed glass**. Ideal for routine analysis.

Displayed in cases of 50 units.

Each case is vacuum flow-packed to protect them from dirtiness.

Each case includes a bag of silica salt. With improved matte band for greater comfort of use: it offers better writing and prevents the slides from sticking together.

Available with polished or cut edges of 45° and 90°.

Expiry date: 24 months.



	code	edges	corners	matt area	case quantity	case weight	case volume
	A D100001	cut 90°	no clipped	no	50 x 50	14.25	0.014
	B D100002	grounded 45°	clipped	no	50 x 50	14.20	0.010
	C D100003	cut 90°	no clipped	yes	50 x 50	14.25	0.014
	D D100004	grounded 45°	clipped	yes	50 x 50	14.25	0.014
NEW	E D100005	grounded 90°	no clipped	no	50 x 50	14.20	0.014
NEW	F D100006	grounded 90°	no clipped	yes	50 x 50	14.20	0.014

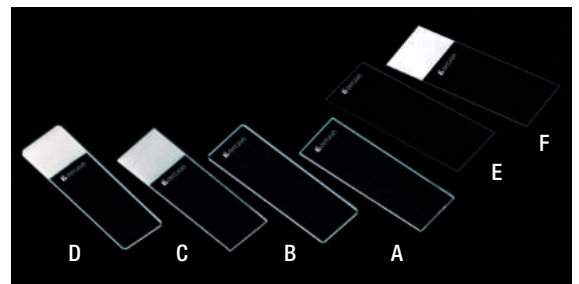

EUROTUBO® cover slides

Standard size: Different according each model. (Please check the table below)

Thickness: 0.145 mm (± 0,015 mm)

Clear, **pre-washed glass**.

Specific use: protection of the sample and lens.

Supplied in cases of a hundred or two hundred units (depending on the code).

Each case includes a bag of silica salt, and is supplied vacuum in tropical pack.

Easy opening, no need for scissors. New improved box which minimize the risk of pack breakage and ensure a better lock.



code	dimensions mm	case quantity	case weight	case volume
D101818	18 x 18	5 x 200	0.30	0.0012
D102020	20 x 20	5 x 200	0.33	0.0011
D102222	22 x 22	5 x 200	0.37	0.0012
D102240	22 x 40	10 x 100	0.65	0.0016
D102424	24 x 24	5 x 200	0.41	0.0011
D102432	24 x 32	10 x 100	0.63	0.0017
D102440	24 x 40	10 x 100	0.68	0.0017
D102450	24 x 50	10 x 100	0.79	0.0017
D102460	24 x 60	10 x 100	0.89	0.0017



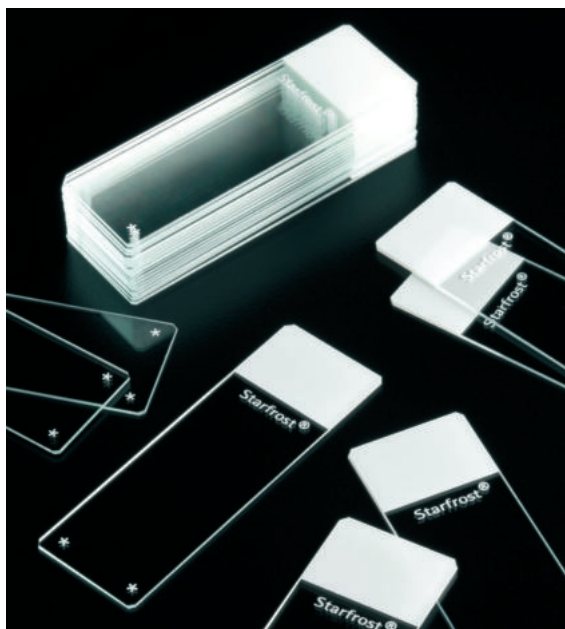

STAR FROST® ADHESIVE slides

Standard size: 26 x 76 mm (± 1 mm).

Thickness: 1 mm (± 0,05 mm). Made in Germany.

High definition, **pre-washed glass**.

Hydrophobic. No stain residues, no proteins in the surface.

Marking area: Feature a white, 20 mm. This special printed area is resistant to all common chemicals used in the laboratories, and may be marked with pencil, ballpoint pen, marker and different laboratory-printers (e.g. Leica XPS). Thanks to the single side printing the user always knows the best surface to be used.

Made in Germany.

StarFrost® Adhesive slides do not show striae and disturbing background staining such as the blue or red background obtained with Haematoxylin and Eosin-staining of tissues on Albumin coated glass, or the brown background obtained during the Immunoperoxidase or In-situ-DNS-Hybridisation process. They are ideal for molecular-hybridization, as being DNase and RNase free there is no need of washing them with chromic-acid.

Available with ground edges 90°.

Supplied in boxes of 50 units.

Final package (20 boxes) by **tropical pack**.

Conforms with ISO 8037/1 (european standard). **Expiry date:** 14 months.

Star Frost® Adhesive slides are treated with silane-coating, which ensures cell-and-tissue-adhesion and supports the forming of covalent bonds between the tissue and the glass surface through electrostatic attraction. So tissue and cell substrates stick rapidly on the surface without using further adhesives or protein coating media, saving costs and time. As the underside is untreated, the Star Frost® Adhesive slides do not tend to stick when stacked or transported as with other competitive products.



TROPICAL PACK:
Aluminium film designed to protect slides from humidity.



code	edges	corners	case quantity	case weight	case volume
A100018	grounded 90°	no clipped	20 x 50	5.02	0.004
A100019	grounded 45°	clipped	20 x 50	4.98	0.004

STAR FROST® slides

Standard size: 26 x 76 mm (± 1 mm). Made in Germany.

Thickness: 1 mm.

High definition, **pre-washed glass**.

Hydrophilic (epoxy).

Feature a colour-coded, 20 mm **marking area**.

This special colour-printed area is resistant to all common chemicals used in the laboratories, and may be marked with pencil, ballpoint pen, marker and different laboratory-printers (e.g. Leica XPS). Thanks to the single side printing the user always knows the best surface to be used.

Ground edges at 45° (angle) and clipped corners.

Supplied in boxes of 50 units.

Final package (20 boxes) by tropical pack. **Expiry date:** 14 months.



code	strip colour	case quantity	case weight	case volume
A100010	white	20 x 50	4.94	0.003
A100011	green	20 x 50	4.98	0.004
A100013	blue	20 x 50	4.94	0.004
A100014	yellow	20 x 50	4.94	0.003

Slide printer microscope slides

Measures: 25 x 75mm
Thickness: 1.1mm

Made of clean, clear and degreased glass, with a colour frosted, hydrophilic, clean and washed white marking area. Resistant to all common laboratory chemicals, high pH, routine stains, etc. and suitable for all common sterilization methods. It is possible to mark with pen, pencil and laboratory marker.

Suitable for manual use and use in printers such as Thermo Slide-Mate® (Thermo-Fisher) slide printer y Signature® (Primer) slide printers.

For other colors, ask to the commercial department.

Expiry date: 18 months

Adhesion microscope slides

Measures: 25 x 75mm
Thickness: 1.1mm

Made of super white glass with positive charge coating specially developed for use in immunohistochemistry (IHC) and other more complex applications. It offers a great adhesion of the tissue on the surface of the slide. In addition, it also improves staining itself. Hydrophilic surface tension.

Suitable for use in manual IHC staining, automatic IHC staining with Leica and Dako automated IHC Stainers and routine H&E staining of detachable tissue sections.

Models D100020 and D100021 are also recommended for Roche Ventana automated IHC Stainer.

Expiry date: 15 months



code	edges	corners	mat area	case quantity	case weight	case volume
D100010	grounded 45°	clipped	yes	50x50	14.2	0.014
D100011	grounded 90°	not clipped	yes	50x50	14.2	0.014



code	edges	corners	mat area	case quantity	case weight	case volume
D100018	grounded 90°	not clipped	yes	72x20	8.5	0.009
D100019	grounded 45°	clipped	yes	72x20	8.5	0.009
D100020	grounded 90°	not clipped	yes	72x20	8.5	0.009
D100021	grounded 45°	clipped	yes	72x20	8.5	0.009





Microscope slide labels 23 x 23 mm

Write on these permanent adhesion labels and stick them onto microscope slides for better identification.

White colour.

Each sheet contains 40 labels (8x5).

Page size: 13.3 x 19 cm.

code	quantity	weight	volume
901600	1,000 labels	0.14	0.0001



Mounting medium for microscopy

VITROCLUD® quick-hardening mounting medium for microscope preparations. Neutral and colourless.

Short hardening time (20 min). Refractive index at room temperature: 1.5. Resistant to heat, cold (down to -17°C), humidity and light including UV rays. It is recommended to close the container immediately after use.

If the medium becomes too viscous, add Xylene.

Supplied in aluminium bottles for a safer storage.

Store at maximum 20°C .

code	description	case quantity	case weight	case volume
A20100	bottle 100 ml	1	0.13	0.0003
A20250	bottle 250 ml	1	0.30	0.0016
A20500	bottle 500 ml	1	0.58	0.0020



Staining tray

Made of ABS.

It will accept 10 or 20 slides on plastic rails covered by a polymer strip to perfectly hold slides even if tray is held at an angle (see picture A).

When humidity is required, wells between rails may hold water, and raised rails will avoid water from touching the slides.

It features a draining plug to ease the emptying of the tray (see picture B).

Four rubber feet ensure stability.

Cannot be used with acetone and chlorinated hydrocarbons.

code	description	lid colour	case quantity	case weight	case volume
989953	staining tray 10 slides	black	1	0.65	0.003
989951	staining tray 20 slides	transparent	1	1.01	0.005
989952	staining tray 20 slides	black	1	1.08	0.050

Stains

code	description	volume	dangerousness	transport rules		CE certificate	case quantity	case weight	case volume
May Grunwald solution									
808000	Eosin	250 ml	H225, H331, H311, H301, H370	ONU 1992. ADR: 3/6.1/II. IMDG: 3/6.1/II. IATA: 3/6.1/II. PAX: 352. CAO: 364		CE (IVD)	16	4.80	0.015
808001	Eosin	1,000 ml	H225, H331, H311, H301, H370	ONU 1992. ADR: 3/6.1/II. IMDG: 3/6.1/II. IATA: 3/6.1/II. PAX: 352. CAO: 364		CE (IVD)	12	13.00	0.045
Giemsa solution									
808100	Eosin	250 ml	H225, H331, H311, H301, H370	ONU 1992. ADR: 3/6.1/II. IMDG: 3/6.1/II. IATA: 3/6.1/II. PAX: 352. CAO: 364		CE (IVD)	16	5.15	0.015
808101	Eosin	1,000 ml	H225, H331, H311, H301, H370	ONU 1992. ADR: 3/6.1/II. IMDG: 3/6.1/II. IATA: 3/6.1/II. PAX: 352. CAO: 364		CE (IVD)	12	13.00	0.045
Wright stain									
808200	Eosin	250 ml	H225, H331, H311, H301, H370	ONU 1992. ADR: 3/6.1/II. IMDG: 3/6.1/II. IATA: 3/6.1/II. PAX: 352. CAO: 364		CE (IVD)	16	4.43	0.015
Gram stain									
Kit 805000	806030	Lugol	250 ml	-	-	-	16	4.90	0.015
	805040	Gentian violet	250 ml	-	-		16	4.80	0.015
	805001	Gram decolorizing	250 ml	-	-		16	4.25	0.015
	805050	Safranin solution	250 ml	H226	ONU 1993. ADR: 3/III. IMDG: 3/III IATA: 3/III		16	4.80	0.015
805001	Gram decolorizing	250 ml	H225, H319, EUH066, H336	ONU 1993. ADR: 3/II. IMDG: 3/II. IATA: 3/II. PAX: 353. CAO: 364		16	4.25	0.015	
806030	Lugol Iodine	250 ml	H412	-	-	-	16	4.90	0.015
805040	Violet crystal solution	250 ml	H302, H351, H318, H410	-		-	16	4.80	0.015
805140	Violet crystal solution	1,000 ml	H302, H351, H318, H410	-		-	12	13.00	0.045
Ziehl stain									
Kit 805010	805020	Fuchsin	250 ml	-	-		16	4.66	0.015
	805030	Methylene blue	250 ml	-	-		16	4.80	0.015
	805011	Ziehl decolorizing	2 bottles of 250 ml	-	-		16	4.46	0.015
805050	Safranin solution	250 ml	H226	ONU 1993. ADR: 3/III. IMDG: 3/III IATA: 3/III		16	4.80	0.015	
805150	Safranin solution	1,000 ml	H226	ONU 1993. ADR: 3/III. IMDG: 3/III IATA: 3/III		12	13.00	0.045	
805120	Ziehl fuchsin solution	1,000 ml	H225, H312, H302, H319, H315, H341	-		12	13.00	0.045	
805030	Methylene blue	250 ml	H302	-		16	4.80	0.015	
805130	Methylene blue	1,000 ml	H302	-		12	13.00	0.045	
805013	Fast stain for blood extensions, Kit with 2 containers of each type containers stain B	250 ml	-	-	-	CE (IVD)	12 Kits	14.95	0.045

Minimum order quantity: 1 bottle or kit. Check with the commercial department for special transport conditions.





Staining jars with lid

Material: **autoclavable TPX**.

Two options available: vertical, "Hellendhall" type (Code **19335**) horizontal "Schiffertecker" type (Code **19351**).

It is recommended to use slides up to 2 mm thick.



code	description	case quantity	dimensions mm	case weight	case volume
19355	vertical, for 8 slides	4	58 x 53.5 x 86	0.28	0.002
19351	horizontal, for 10 slides	4	76 x 65 x 45	0.32	0.002



Staining jar

Made of **POM** (polyoxymethylene).

Colour: black. Ideal for slide staining.

Good resistance to alcohols and xylol (not to phenol).

Consists of a jar with a lid for slide staining.

Leakproof. Includes a white perforated slide partition for drying.

Not suitable for microwaves.

It is recommended to use slides up to 1 mm thick.

code	dimensions mm	case quantity	case weight	case volume
191101	100 x 87 x 51	1	0.10	0.0004

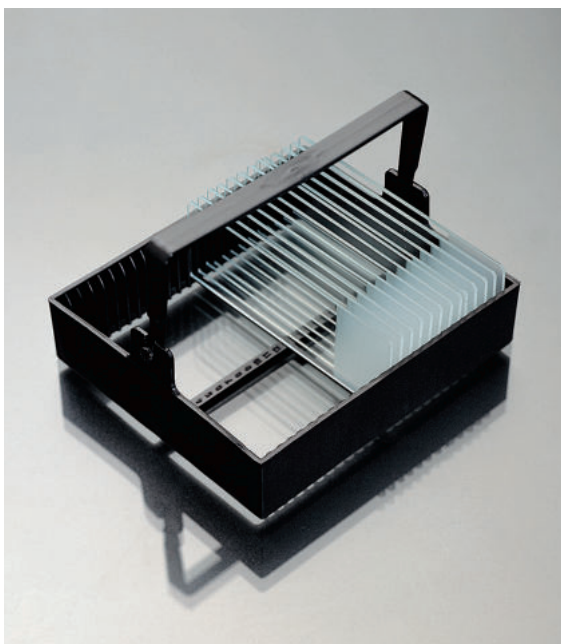

Staining rack

Made of **POM** (polyoxymethylene). Colour: black. Ideal for slide staining.

Good resistance to alcohols and xylol (not to phenol). Accepts 25 slides.

Includes a folding handle, and 25 numbered slots to facilitate classification.

Slides insert easily in the rack. The rack ideally fits into the staining trough presented above.

No suitable for microwaves.

This product fits in the code 19360.

It is recommended to use slides up to 1 mm thick.



code	dimensions mm	case quantity	case weight	case volume
191100	91 x 79 x 38	1	0.03	0.001

Staining system

Slide staining system compound of a range of jars, and a 12 slides staining rack. Different jar colours allow the user to distinguish each stage of the staining process. Jar and rack made of **autoclavable** POM (polyoxymethylene), resistant to staining agents as alcohol, xylene, etc. (not phenol).

The jar embodies a hinged lid which allows storing the jar with the content.

Reagent capacity: 80 ml.

Jars can be loosely joined to each other laterally (picture 1).

The rack features a handle in the hinged lid, and can be placed up when handled out of the jar. Since the slides are placed vertically in the rack, their writing area will not be stained, allowing their removal without the use of forceps (picture 2).

Rack and jar withstand from **-170 °C** and **121 °C**.

Jar dimensions: 64 x 76 x 92 mm.

Rack dimensions: 60 x 64 x 97 mm.



code	description	case quantity	case weight	case volume
191104	blue jar	6	0.72	0.0059
191105	green jar	6	0.78	0.0059
191106	white jar	6	0.68	0.0059
191107	yellow jar	6	0.68	0.0059
191108	dark grey rack	6	0.32	0.0024



Staining jar and dish

Dish made of polypropylene and jar made of **autoclavable** TPX. The jar is supplied with two lids. The first lid provides evaporation free storage of staining liquid when the dish is not in use. The second includes a slot to allow staining dish insertion.

Code **19353**: height (with lid) 70 mm, height (without lid) 65 mm, length 100 mm and width 75 mm.

Code **19354**: height 21 mm, length 83 mm, width 70 mm and length (handle) 160 mm.

It is recommended to use slides up to 1 mm thick.



code	description	case quantity	case weight	case volume
19353	jar with 2 lids	4	0.49	0.006
19354	staining dish for 20 slides	2	0.06	0.001



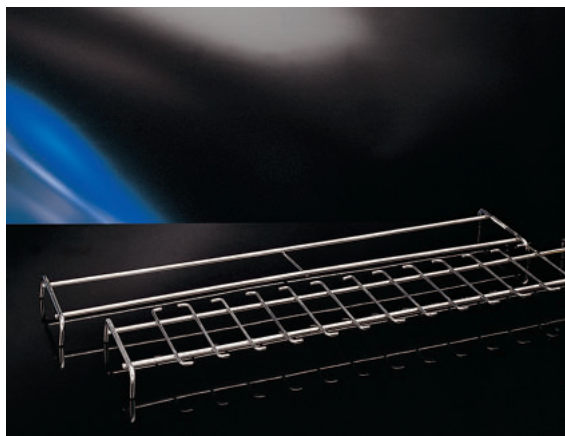

Staining racks

Stainless steel.

Models **S-004** and **S-002** can be leaning over to drain off the stain without falling the slide.



code	description	case quantity	case weight	case volume
S-004	for 12 slides length: 435 mm. width: 85 mm	1	0.25	0.003
S-002	for 24 slides length: 435 mm. width: 175 mm	1	0.36	0.003
S-003	without dividers length: 435 mm. width: 85 mm	1	0.21	0.003

Other stainless steel models can be made on request.



Staining jar and basket

Code **19360** is a stainless steel staining jar.

With a lid to avoid evaporation.

Made of stainless steel, this staining basket is designed for 30 slides of 26 x 76 mm for use in the above staining jar, code **19360**.

Includes an adjustable handle for more convenience.



code	description	dimensions mm	case quantity	case weight	case volume
19360	jar	115 x 88 x 77	1	0.42	0.001
19361	basket	110 x 85 x 55	1	0.13	0.001



Special baskets and trays for slides

Baskets are manufactured from stainless steel wire.

Model **CP-30** has folding handles.



code	description	dimensions mm	case quantity	case weight	case volume
CP-30 H	basket for 30 horizontal slides	172 x 86	1	0.12	0.0011
CP-45 H	basket for 45 horizontal slides	235 x 85	1	0.17	0.0017
CP-30	basket for 30 vertical slides	70 x 165*	1	0.20	0.0025

* Height with handle



Coplin type staining jar

Jar made of opaque white, unbreakable and **autoclavable** polypropylene, designed for staining 5 standard microscope slides.

Rectangular container with rounded base and screw ribbed flat cap with an inner ring for preventing leakage.

Used as a storage system, it can hold up to 10 slides (2 per groove).

Dimensions: Base diameter: 60 mm.

Height of jar: 110 mm. Height of jar with cap: 114 mm.

It is recommended to use slides up to 1.1 mm thick.



code	description	case quantity	case weight	case volume
191087	coplin jar for 5 slides	12	0.92	0.007

Slidefolders

Available in 2 materials, in polystyrene or in cardboard. They can contain 20 standard slides.

Polystyrene model: The base containing the slides is numbered from 1 to 20. Resistant from **-80 °C to 100 °C**.

Not autoclavable The transparent cover, by way of two windows, foldable. Very easy opening. External dimensions: 192 x 292 x 11 mm. The two covers being closed, for the protection of the slides, the identification of the sample labels can be seen perfectly.

The slides are easily removed by pressing with one finger on the side. Stackable.



code	material	colour	case quantity	case weight	case volume
989945	PS	blue	10	3.20	0.013
NEW 989919	paperboard	brown	50	15	0.037

* Minimum unit of sale 5 units.

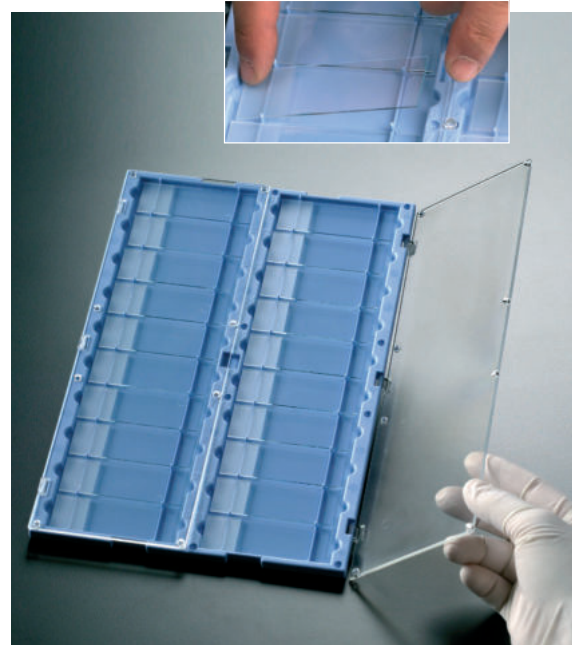

Slide tray

Made of high impact polystyrene. It will hold up to twenty standard slides. The slide tray is easily stackable and will take minimum space on any shelf or laboratory counter.

Not autoclavable.

External dimensions: 206 x 299 x 18 mm.

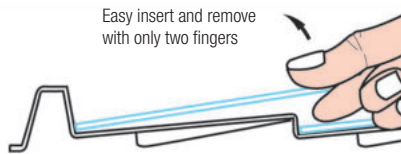

See our slides on pages 101-103



code	colour	case quantity	case weight	case volume
989956	white	10	0.91	0.013

For other colors consult with the commercial department.

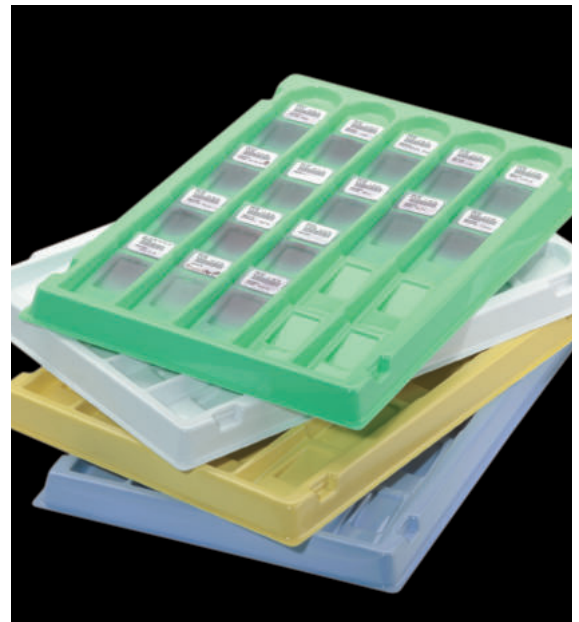

Slide trays

Very light polystyrene trays.

White color.

Stackable



code	description	dimensions mm	case quantity	case weight	case volume
989910	slide tray for 10 slides	100 x 340 x 17	40	2.50	0.015
NEW 989921	slide tray for 20 slides	194 x 297 x 12	20	4.30	0.013



Slide mailer

Made of polypropylene. Designed for slide transport and protection. To send by mail we recommend to use special envelopes. Compartment shape ensures tight fit: no risk of damaging slides. Easy snap-lock. but not indicated for liquid samples.

mod.	code	material	slide capacity	dimensions mm (length x width x height)	case quantity	case weight	case volume
1	19923	PP	1	80 x 40 x 6	50	0.33	0.002
2	900025	PP	2	87 x 47 x 16	100	1.27	0.010
3	979930	PP	2	84 x 71 x 6	250	3.98	0.010
4	19924	PP	3	84 x 99 x 6	10	3.30	0.001
5	900028	PP	5	82 x 17 x 29	100	1.02	0.012
6	989901*	paperboard	1	40 x 94 x 20	1,000	12.5	0.030
	989902*	paperboard	2	75 x 94 x 20	500	11.5	0.030

* Minimum unit of sale 50 units.



Slide tube mailer

Tube in polypropylene for mailing, staining and storing of 4 standard slides. Leakproof cap made of high density polyethylene in pink colour. Incorporates a **tamper evident locking mechanism** that can be activated whenever user decides. The cap has one space to insert a colour disc as identification (**40911A**, chapter 6. Tubes and microtubes). Being transparent helps the user to notice if there are slides in it, an advantage in front of the popular white transparent tubes. Internal volume: 12 ml.

Dimensions: 35 x 87 mm (external). Internal diameter: 27 mm

code	description	case quantity	case weight	case volume
19926	tamper evident tube	100	2.00	0.018

Slide storage boxes

Manufactured in ABS, beige or blue colour. Economical boxes to store or transport 25, 50 or 100 slides.

Safe closing and easy opening.

They include numbered sheets with a labeling space in the bottom of the case and in the inner side of the cover (excepting model 1, which does not include the one in the inner side of the cover).

Models 2 and 3 have a special modeling assuring a good stability when stacked.

It is recommended to use slides up to 2mm thick.

mod.	code	slide capacity	colour	stackable	minimum order quantity	dimensions mm	case quantity	case weight	case volume
1	19276.B	beige slide box for 25 slides	●		5	93 x 87 x 32	200	10.61	0.071
	19276.A	blue slide box for 25 slides	●		5	93 x 87 x 32	200	10.61	0.071
2	19277.B	beige slide box for 50 slides	●	✓	2	200 x 89 x 32	100	11.28	0.071
3	19278.B	beige slide box for 100 slides	●	✓	5	200 x 170 x 32	50	11.85	0.071
	19278.A	blue slide box for 100 slides	●	✓	5	200 x 170 x 32	50	11.85	0.071

mod. 2, 3

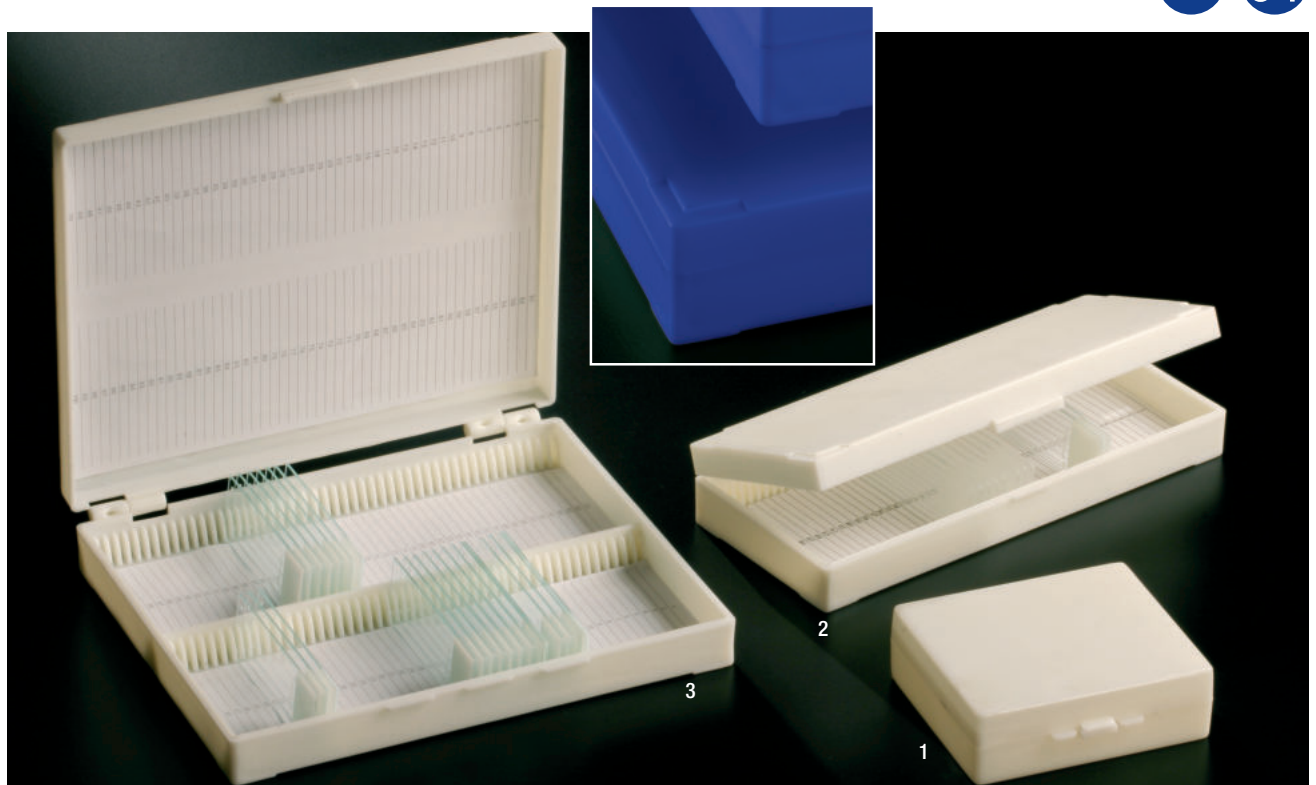

Cylindrical slide mailer

Polypropylene. Ideal for storing and transporting 5 to 10 slides in complete safety. The deep threaded container provides a leakproof seal for transport.

It is recommended to use slides up to 1.2 mm thick.



code	description	case quantity	case weight	case volume
19922	for 10 slides	10	0,33	0,0028



Slide storage boxes

Manufactured in **ABS** for 100 slides. Capacity can be doubled if two slides are placed into the same cell. The internal cork lining prevents damage to stored slides. To ensure proper slide identification, each slot is numbered to correspond to the slide inventory sheet on the inside cover of the box.

Stackable.

Dimensions: 208 x 162 x 32.

It is recommended to use slides up to 1 mm thick.



code	description	case quantity	case weight	case volume
19278.2	red, for 100 slides	1	0.37	0.002
19278.3	white, for 100 slides	1	0.37	0.002



Microscope slide boxes

Made of high impact grey polystyrene, those boxes are designed for slides. Each slot is numbered and can be cross-referenced with the corresponding index card supplied with each box.

Boxes are virtually unbreakable. Stackable.

Dimensions mm: 230 x 97 x 35 (50 slides), 230 x 180 x 35 (100 slides).

It is recommended to use slides up to 2 mm thick.



code	description	case quantity	case weight	case volume
19277	for 50 slides	1	0.24	0.002
19278	for 100 slides	1	0.40	0.003



Slide boxes

Plain polyethylene slide box with clear polypropylene lid.

Not numbered.

Stackable.

Dimensions in mm: 105 x 88 x 32 (25 slides), 200 x 88 x 32 (50 slides)



code	description	case quantity	case weight	case volume
19276.1	for 25 slides	48	3.56	0.019
19277.1	for 50 slides	24	3.40	0.018



Automatic slide dispenser

Made of ABS and PS, this dispenser can hold up to 50 standard slides. Slides are dispensed individually by rotating the knurled knob on either side of the moulded base.

It is recommended to use slides up to 2 mm thick.

code	description	case quantity	case weight	case volume
19540	for 50 slides 26 x 76 mm	1	0.20	0.002

Slide storage system for 100 slides. Stackable

Made of high impact polystyrene. It can hold up to 200 standard slides.

Compound by a box with a transparent lid with an easy opening and an internal removable rack.

This removable rack is divided into two parts with 50 numbered slots in each one, so 100 slides can be separately placed and their strips can be read. For space saving purposes, you can double the amount of slides simply by storing 2 slides per slot, so each part can hold up to 100 slides resulting in a total capacity of 200 slides. They can also be used without the internal rack, so the capacity reaches 400 slides.

Stackable. The internal rack allows discarding all the slides at the same time. The frontal part of the box can be written.

External **dimensions**: 82 x 245 x 86 mm.

code	colour	case quantity	case weight	case volume
19279.5	blue	10	3.30	0.023
19279.7	green	10	3.30	0.023
19279.3	yellow	10	3.30	0.023

See minimum and delivery time for other colors.

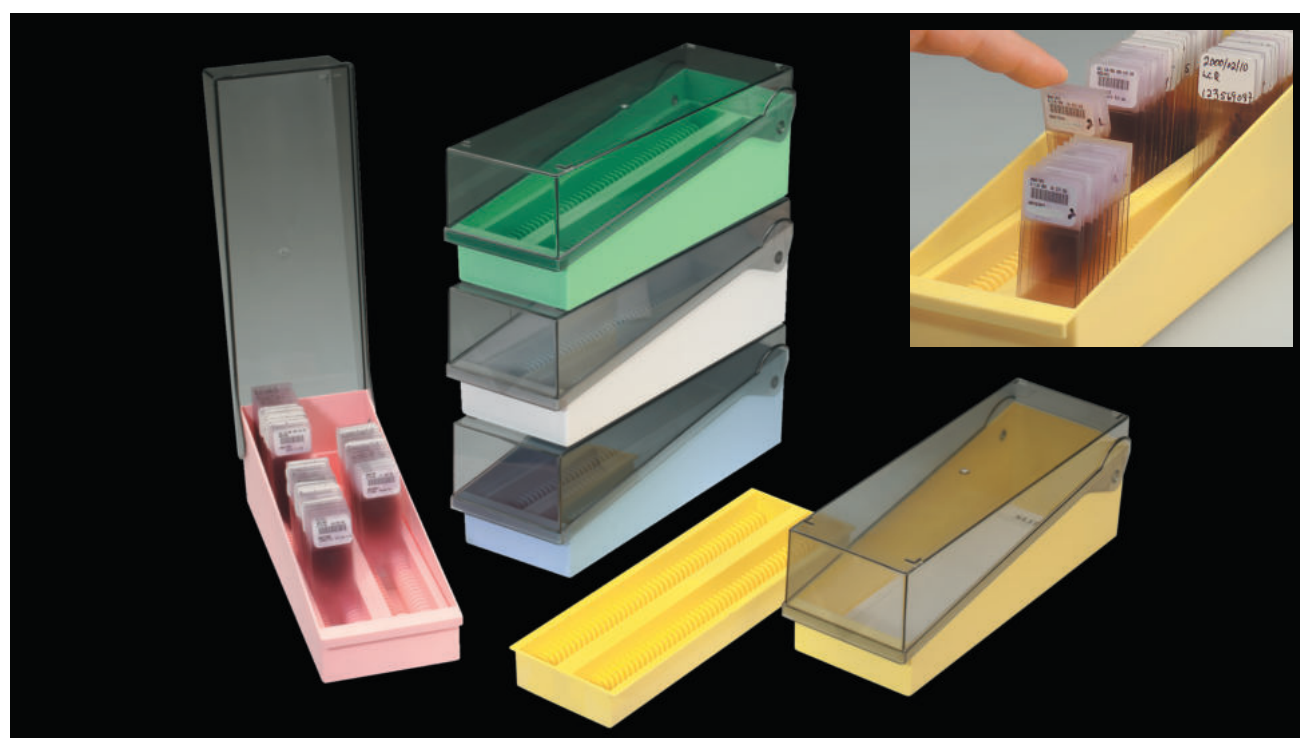

Slide storage system for 50 slides. Stackable

Same characteristics as previous codes, it has half capacity. Each part of the inner rack can hold up to 25 separate slides with a total capacity of 50 slides, or for space saving purposes it has a total capacity of 100 slides by storing 2 slides in each slot.

External **dimensions**: 82 x 140 x 86 mm.



code	colour	case quantity	case weight	case volume
19274.5	blue	10	1.5	0.013

Minimum order quantity: 1 storage system.





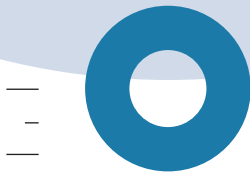

CONTAINERS. SAMPLING

 deltalab

30 ml universal polystyrene containers (25 x 90 mm)

Polypropylene caps. 30 ml containers. These containers are manufactured with an innovative process resulting in one of the most resistant containers available on the market.

The standard cap colour is white.

Other colours can be supplied (ask for quantities).

mod.	code	description	sterile	case quantity	case weight	case volume	cases pallet
1	309202	polystyrene	no	400	5.20	0.045	32
2	309222	polystyrene individually wrapped	no	400	5.70	0.045	32
2	309222.0	polystyrene individually wrapped	STERILE EO	400	5.32	0.045	32

Withstand centrifugation up to: **7,000 xg**.

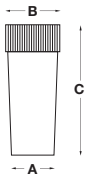

Dimensions:

A: 25.1 mm; B: 30.8 mm; C: 92.5 mm.

Maximum volume: 31,7 ml.

Recommended volume: 25 ml.



30 ml container with boric acid (25 x 90 mm)

This container includes a boric acid preservative which allows the storage and transport of the urine sample to the laboratory.

The boric acid supports the viability of the bacteria while preventing further multiplication. This preservative does not alter the characteristics of the urine and will not affect analysis. The bacteria remain viable for 24-48 hours or more, depending on the type of microorganisms.

Boric acid quantity: 0.4 g. **Sterile by ethylene oxide.**

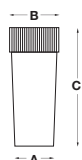

Dimensions:
 A: 24.8 mm; B: 30.8 mm; C: 91.6 mm.
Maximum volume: 31,1 ml.
Recommended volume: 20 ml.



code	description	case quantity	case weight	case volume	cases pallet
409202.B	polypropylene with boric acid	400	5.70	0.045	32

30 ml universal polypropylene containers (25 x 90 mm)

Made in Polypropylene. 30 ml containers. These containers are manufactured with an innovative process resulting in one of the most resistant containers available on the market.

The screw closure can assure an almost leakproof closing system.

Polypropylene cap in white colour, except **409602** (blue). Other colours and labeled models can be supplied (ask for quantities).

Autoclavable (except the code **409602**, the polystyrene spatula must be removed before autoclaving).

mod.	code	description	sterile	case quantity	case weight	case volume	cases pallet
1	409202	polypropylene	no	400	4.50	0.040	32
2	409222	polypropylene individually wrapped	no	400	5.10	0.045	32
2	409222.0	polypropylene individually wrapped	STERILE EO	400	5.10	0.045	32
3	409602	polypropylene with PS spoon	no	400	4.70	0.044	32

Withstand centrifugation up to: **10,000 xg.**

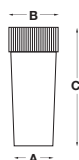

Dimensions:
 A: 24.8 mm; B: 30.8 mm; C: 91.6 mm.
Maximum volume: 31,1 ml.
Recommended volume: 25 ml.





40 ml containers (30 x 70 mm)

With polyethylene caps. Graduated.
Volume 40 ml.

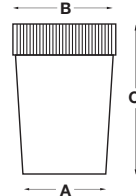

Dimensions:

A: 29.1 mm; B: 35.7 mm.
C: 69.8 mm.

Maximum volume: 39 ml.

Recommended volume: 30 ml.

code	description	case quantity	case weight	case volume	cases pallet
409402	ultra clear polypropylene	8 x 100	8.35	0.096	16
409426	ultra clear polypropylene, individually wrapped	800	10.50	0.110	16
309402	polystyrene	8 x 100	11.00	0.096	16

50 ml containers (38 x 70 mm)

With polyethylene caps.
Volume: 50 ml.

code	description	case quantity	case weight	case volume	cases pallet
409802	ultra clear polypropylene	700	9.30	0.096	16
409852	ultra clear polypropylene with PS spoon	700	9.30	0.096	16
409826	ultra clear polypropylene individually wrapped	600	8.40	0.096	16

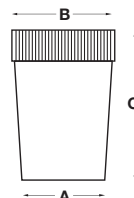

Dimensions:

A: 35.1 mm; B: 41.5 mm; C: 72.3 mm.

Maximum volume: 56 ml.

Recommended volume: 45 ml.



50 ml tamper evident containers (38 x70 mm)

Ultra clear polypropylene containers with a specially designed tamper evident ring.
Polyethylene caps. Standard colour of caps: red. Volume: 50 ml.

code	description	case quantity	case weight	case volume	cases pallet
419802	ultra clear polypropylene	700	9.42	0.096	16
419826	ultra clear polypropylene individually wrapped	600	8.40	0.096	16

Containers are supplied capped but not fully locked so that the container is not fully sealed.
Once samples (urine, milk, water, etc.) are collected, screw the cap in a normal way and then screw again to fully position the tamper evident ring.



The seal ring will be automatically broken when unscrewing

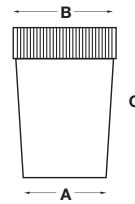

Dimensions:

A: 35.1 mm; B: 41.5 mm; C: 72.3 mm.

Maximum volume: 56 ml.

Recommended volume: 45 ml.

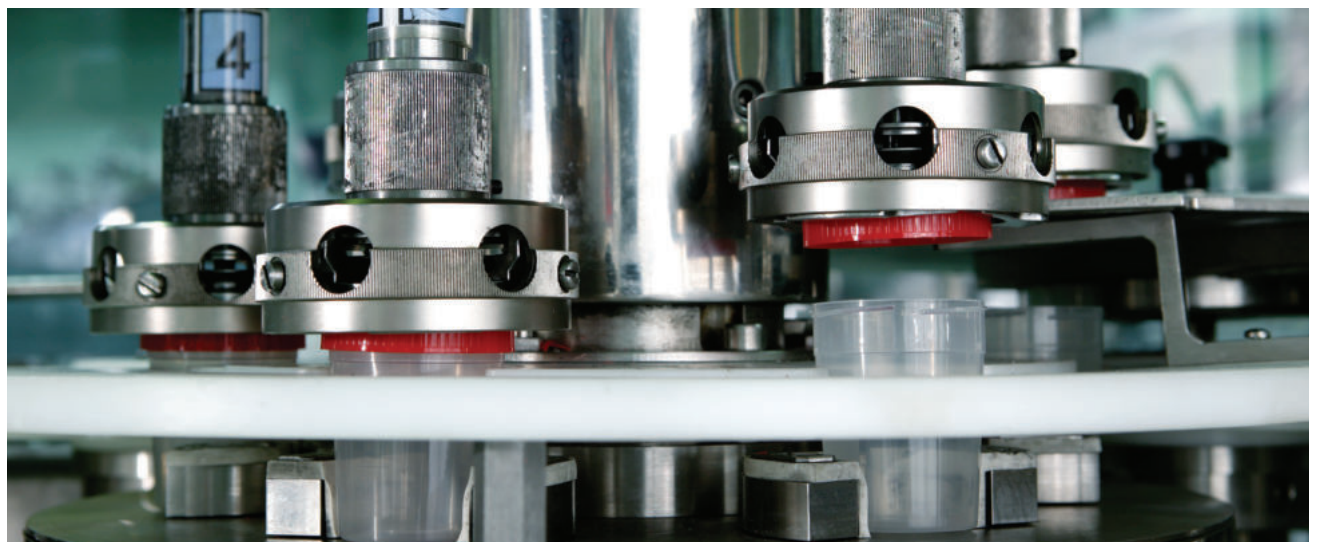

60 ml polystyrene containers (38 x 65 mm)

New generation of 60 ml containers with high safety closure biflex caps.

Caps made of polyethylene.

Standard colour of the cap: red. Possibility of supplying the labeled bottles. (Consult minimum quantities).

mod.	code	description	sterile	case quantity	case weight	case volume	cases pallet
1	309502	polystyrene	aseptic	600	9.10	0.096	20
2	309552	polystyrene with spoon	aseptic	600	9.10	0.096	16
3	309526	polystyrene individually wrapped	STERILE A	750	11.06	0.140	12

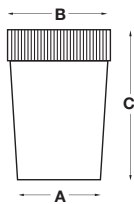

Dimensions:

A: 39.3 mm; B: 44.2 mm;

C: 66.0 mm.

Maximum volume: 63 ml.

Recommended volume: 50 ml.

STERILE A STERILIZATION TYPE: in this case the parts are not sterilized at the end of its manufacture process since is the process by itself which is able to obtain a sterile product. This is because the entire process from injection of different plastic components to the assembly is protected by a sterile atmosphere, thanks to the cowl of the entire installation and the placement of laminar flows that create an overpressure sterile air inside the facilities.

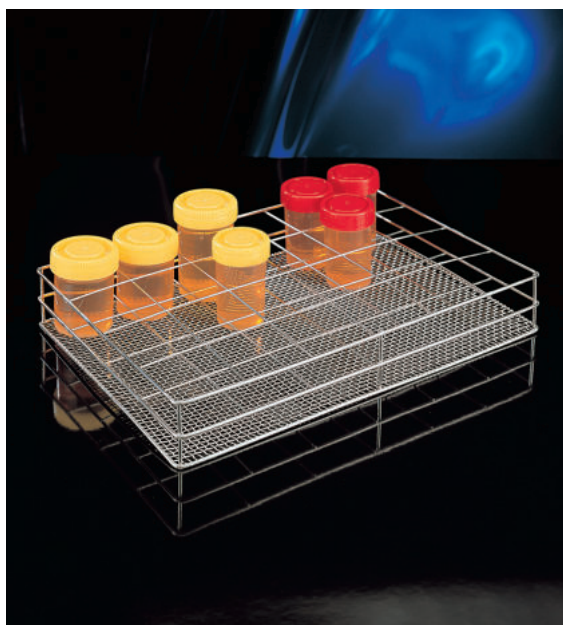

Racks for containers up to 47 mm Ø

Stainless steel. 50 mm square holes.

With a strong woven mesh base.



See metal racks in chapter **Sample Storage**



code	dimensions mm	distribution	quantity	weight	volume
I-240	315 x 210 x 45	24 (6 x 4)	1	0.35	0.0042
I-250	210 x 160 x 45	12 (4 x 3)	1	0.25	0.0022

60 ml polypropylene containers (38 x 65 mm)

New generation of 60 ml sterile containers with high safety closure biflex caps. Specially designed for pneumatic transport of specimens. Caps made of polyethylene. Standard colour of the cap: red.

mod.	code	description	sterile	case quantity	case weight	case volume	cases pallet
1	409501	polypropylene labelled	aseptic	600	8.00	0.096	16
2	409502	polypropylene	aseptic	600	7.90	0.096	16
3	409552	polypropylene with spoon	aseptic	600	8.25	0.096	16
4	409526	polypropylene individually wrapped	STERILE A	750	10.15	0.140	12
-	409526.0	polypropylene individually wrapped	STERILE EO	750	10.30	0.140	12
5	409526.1	polypropylene individually wrapped, labelled	STERILE A	750	10.13	0.140	12

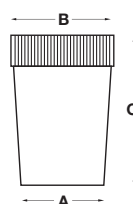

Dimensions:
 A: 38.8 mm; B: 44.2 mm; C: 66.1 mm.
Maximum volume:62 ml.
Recommended volume: 50 ml.



Graduated 60 ml containers 38 x 65 mm

Made of transparent polypropylene. Moulded graduation in 5 ml increments. Red polyethylene cap, biflex. For other cap colours ask the minimum order quantities. Supplied capped.

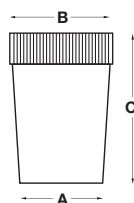

Dimensions:
 A: 38.8 mm; B: 44.2 mm; C: 66.1 mm.
Maximum volume:62 ml.
Recommended volume: 50 ml.



code	description	sterile	case quantity	case weight	case volume	cases pallet
409502G	polypropylene	aseptic	600	8.07	0.096	16
409526G	polypropylene, individually wrapped	STERILE A	750	10.50	0.140	12



150 ml containers (57 x 73 mm) with spoon

Ultra clear polypropylene containers with polyethylene leak proof screw caps. Spoon made of Polystyrene. Graduated in 100 ml increments. Frosted panel on side for easy writing. Standard colour of the cap: red. Possibility of supplying sterile bottles by radiation. (Consult minimum quantities).

mod.	code	description	sterile	case quantity	case weight	case volume	cases pallet
1	409752	polypropylene with PS spoon	no	450	8.14	0.140	16
2	409756	polypropylene individually wrapped with PS spoon	no	350	6.80	0.140	16
2	409756.B	polypropylene individually wrapped with PS spoon	STERILE R	350	6.50	0.140	16

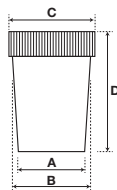

Dimensions:
 A: 48.3 mm; B: 56.3 mm; C: 62.1 mm; D: 74.3 mm.
Maximum volume:150 ml.
Recommended volume: 125 ml.

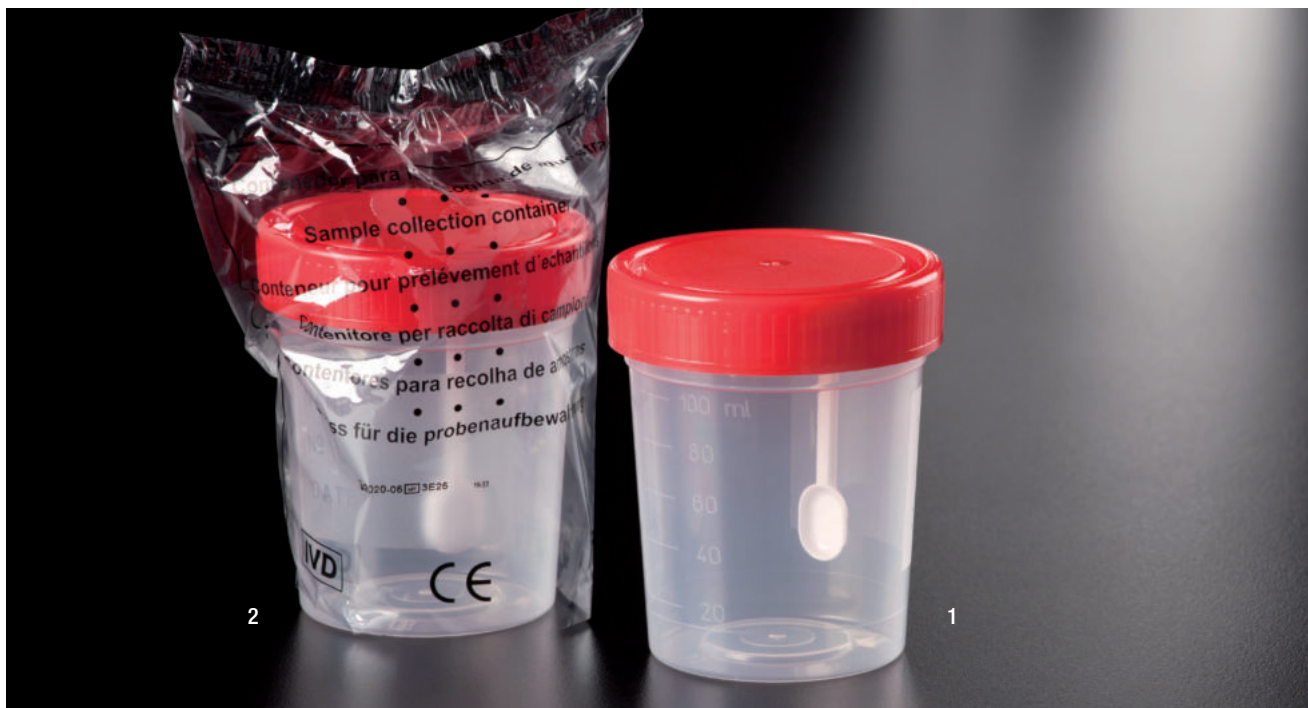

150 ml screw cap containers (58 x 69 mm)

Manufactured in polystyrene or polypropylene depending on the model. Cap manufactured in polyethylene. Code 309752 is supplied with a polystyrene spoon inside. Code 409700 is sterile by radiation.

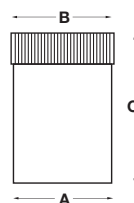

Dimensions:
 A: 58 mm; B: 62 mm; C: 69 mm.
Maximum volume:150 ml.
Recommended volume: 125 ml.

mod.	code	description	sterile	case quantity	case weight	case volume
1	309752	polystyrene white cap and spoon	no	360	13.45	0.106
2	409700	polypropylene red cap	STERILE R	360	11.58	0.106

150 ml containers (57 x 73 mm)

Ultra clear polypropylene containers with polyethylene leak proof screw caps. Moulded graduation in 20 ml increments up to 100 ml. Frosted panel on side for easy writing. Standard colour of the cap: red.

mod.	code	description	sterile	case quantity	case weight	case volume	cases pallet
1	409701	polypropylene labelled	aseptic	450	7.95	0.140	16
2	409702	polypropylene	aseptic	450	7.72	0.140	16
3	409726	polypropylene individually wrapped	STERILE A	350	6.45	0.140	16
-	409726.G	polypropylene individually wrapped	STERILE R	350	6.45	0.140	16

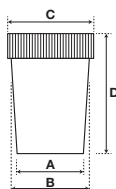

Dimensions:
 A: 48.3 mm; B: 56.3 mm; C: 62.1 mm; D: 74.3 mm.
Maximum volume: 150 ml.
Recommended volume: 125 ml.



150 ml containers uncapped (57 x 73 mm)

With the same characteristics as the previous model, but these containers are supplied uncapped.
 Containers and caps are supplied in the same box.

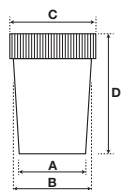

Dimensions:
 A: 48.3 mm; B: 56.3 mm; C: 62.1 mm;
 D: 74.3 mm.
Maximum volume: 150 ml.
Recommended volume: 125 ml.



code	description	case quantity	case weight	case volume	cases pallet
409703	polypropylene uncapped	620	10.05	0.089	20



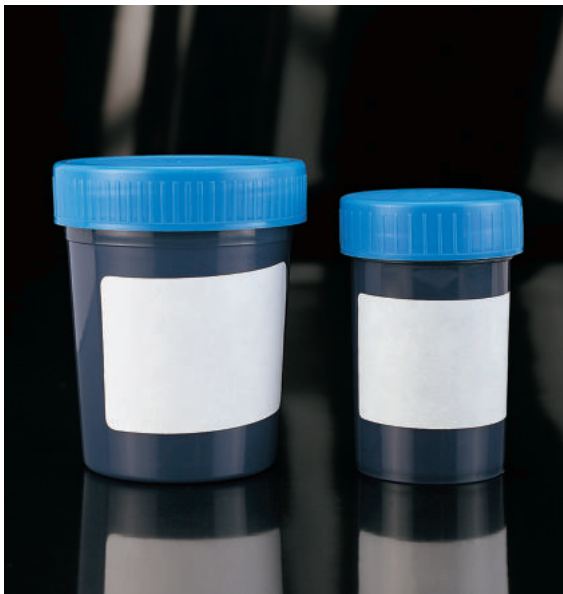

Blue containers (60 and 150 ml)

With the same characteristics as codes **409702** and **409502** but in blue colour (containers and cap). Ideal for photosensitive samples or when it is required not to show the content. Ask for other labeling or for not labeled containers to our commercial department.

Minimum order quantity: 30,000 units.

Minimum order quantity: 1 pallet.



code	description	case quantity	case weight	case volume	cases pallet	quantity pallet
409511	60 ml container white label	600	8.20	0.096	16	9,600
409711	150 ml container white label	450	7.80	0.140	16	7,200



200 ml graduated container (57x116 mm)

Containers made of ultra clear polypropylene and caps made of polyethylene. Those containers have double moulded-in graduations, (in 20 ml increments up to 200 ml and in 1 oz increments up to 7 oz), and feature a frosted panel on their side for easy writing. Standard colour of caps: red.

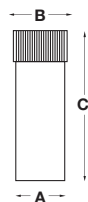

Dimensions:

A: 56.5 mm; B: 62.2 mm;

C: 115.5 mm.

Maximum volume:240 ml.

Recommended volume: 210 ml.



code	max. capacity	case quantity	case weight	case volume	cases pallet
409902	240 ml	275	7.20	0.140	16



200 ml screw cap container (58 x 95 mm)

Manufactured in polystyrene, cap made of white polyethylene.

Total volume: 220 ml.

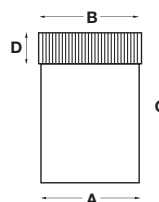
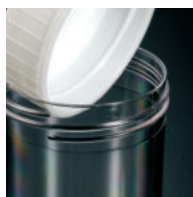

Dimensions:

A: 58 mm; B: 62 mm;

C: 95 mm; D: 22 mm.

Maximum volume:240 ml.

Recommended volume: 210 ml.

code	max. capacity	case quantity	case weight	case volume	cases pallet
309903	220 ml	300	9.6	0.090	16

Urine container set

Urine collection system designed to save space in the lab, and to be used when urine samples need to be collected into tubes for a subsequent centrifugation. Designed to be user friendly. The patient urinates in the 150 ml plastic cup and then pours the urine into the tube. Once the tube is filled up, the patient caps it and delivers the sample to the lab, where the health assistant will fill in the label with the required data. The patient just has to follow the hospital or laboratory instructions. **Manufactured under aseptic conditions.** There are several versions and custom-designed versions can be manufactured. Bad printed with batch number and expiry date. Easy pouring. We can manufacture sets with boric acid.



150 ml cup



150 ml container (body)



code	bag	container	tube	cap	capped	cap colour	label 25 x 35 mm	labelled	case quantity	case weight	case volume
309324.E3	☑	150 ml cup	400705	308102	☒	natural	☒	☒	300	4.15	0.140
309316	☑	150 ml cup	400705	308107	☑	green	☒	☒	300	4.10	0.140
319324.E13	☑	150 ml cup	2 x 400705 with boric acid	308102 / 308105	☑	natural/blue	☑	☑	300	5.96	0.140
309324	☑	150 ml cup	401204	308207	☑	green	☒	☒	300	4.70	0.140
309324.PS	☑	150 ml cup	301201	308202	☑	natural	☒	☒	300	4.70	0.140
319324.E10	☑	150 ml cup	300705	308102	☒	natural	☒	☒	4800	4.30	0.140

Disposable cups

Disposable sample cups, for general sample collection. Cups are supplied stacked.



code	volume ml	material	mouth Ø x height	case quantity	case weight	case volume
202248	100	polypropylene	57.5 x 62	40 x 100	5.53	0.070
202317	150	polystyrene	70 x 70	30 x 100	8.32	0.080

“Fast read” plate for urinary sediment cell count

Disposable plate for determining µl cells in the sample. Using this system a smaller number of epithelial cells present in each field can be achieved, reducing the possibility of overlap with other cells. Ensures a more careful and precise result, providing technical staff to determine presence of cellular elements.

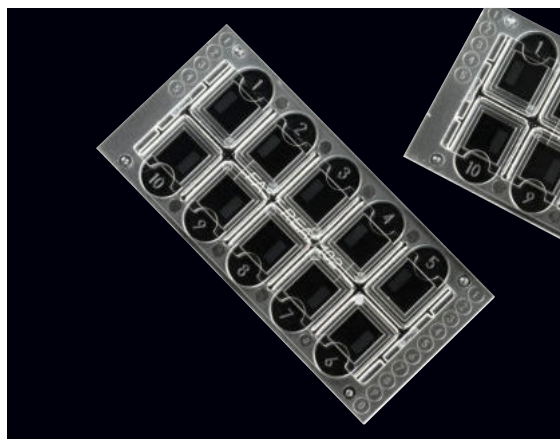

code	description	case quantity	case weight	case volume
141746	fast read plate for urinary sediment cell count	100	0.30	0.0008

Containers and tubes for vacuum system

120 ml containers designed to use with vacuum tubes. It allows a clean transfer of the urine from the container to the vacuum tube.

Manufactured in transparent **Polypropylene**.

Leakproof cap made of yellow **polyethylene**, with an internal obturating ring. It includes a cannula with a needle inside protected by a rubber cap and a plastic suction nozzle.

The cap features a label that seals the cannula in order to prevent contact with the collection needle. The container features a wide marking area for sample identification and a graduation that helps to quantify the sample when uncapped. Once capped, the graduation is inaccurate as the volume is altered by the cannula.

Maximum volume with cap: 120 ml,

Recommended volume: 60 ml.

Tubes in PET produced with the inner cap in caoutchouc and outer cap in yellow polyethylene. Incorporate label for sample identification, with white background and a transverse line in yellow to easily see that it is a tube for urine. Printed with the lot, expiration date, CE mark, volume of suction, manufacturer, and only one-use symbol.

Label dimensions: 36 x 20 mm.

Supplied in foam racks of 100 units, shrink-wrapped and labelled.

This is a completely hygienic and safe system.
It prevents sample loss and avoid the contamination of the sample, the user or the work environment.

code	presentation	expiration	sterile	case quantity	case weight	case volume
1- 120 ML CONTAINER (dimensions: 57x73 mm)						
408702	in bulk	60 months	no	475	9.31	0.140
408726	individually wrapped	60 months	no	350	7.39	0.140
408702.G	in bulk	48 months	STERILE R	400	8.16	0.140
408726.G	individually wrapped	48 months	STERILE R	350	7.40	0.140
2- VACUUM TUBE (dimensions: 16x100 mm)						
408900.K	vacuum tube, 9 ml	18 months	STERILE R	10 x 100	12.60	0.062
408910.K	vacuum tube, 9 ml with boric acid	18 months	STERILE R	10 x 100	13.70	0.044
3- KIT CONTAINER AND VACUUM TUBE						
408720	KIT 408702.G + 408900.K	18 months	STERILE R	250	3.90	0.100
408721	KIT 408702.G + 408910.K	18 months	STERILE R	250	4.10	0.110
408711	KIT 408702 + 408910.K	18 months	CONTAINER NO TUBO: STERILE R	250	3.90	0.100



System for vacuum collection

Device for vacuum urine collection designed for use with tubes with the vacuum system.

Is composed by:

- Transparent polypropylene holder
- Needle adaptor in White colour. The needle is made of stainless steel AISI 304 wrapped with a synthetic rubber protection.
- Polypropilene cannula diametre 2.4-2.5mm
- Individually wrapped

code	total lenght mm	cannula lenght mm	case quantity	case weight	case volume
408914	140	75	1,200	5.20	0.070
408922	220	160	1,200	5.20	0.070

*Suitable with vacuum tubes **408900.K** and **408910.K**.



Rectangular graduated until 3 litres container with handle

Product designed for collection of 24 hours urine samples. Container made of polyethylene and cap of polypropylene.

Brown opaque body and cap depending on the model:

- **408600** Yellow cap with vacuum system
- **408601** Yellow cap with vacuum system with long canula
- **408610** Standard white cap

The three of them are completely leakproof thanks to its sealing ring and ensure a total sealing of the sample.

The vacuum system ensures a clean transfer of the urine from the container to the vacuum tube and prevents the risk of cross contamination in the handling of the sample. It also avoids sample loss by splashing or outpouring.

The container has a handle with ergonomic empty space to facilitate a much more comfortable dump and the manual transport of the sample. It incorporates a translucent vertical stripe on one side where the graduation allows the control of the level of sample containing. Graduated each 100 ml, to 3,000 ml.

Total capacity: 3.3 l.

Unit weight (without cap): 115 g (\pm 3 g).

Cap weight (vacuum system): 8.2 g (\pm 0.2 g).

Cap weight (standard system): 5.5 g (\pm 0.2 g).

code	presentation	sterile	case quantity	case weight	case volume	cases pallet
408600*	3 l rectangular container with vacuum system	no	30	4.57	0.150	12
408601*	3 l rectangular container with vacuum system and long canula	no	30	4.57	0.150	12
408610	standard 3 l rectangular container	no	30	4.52	0.150	12

*Suitable with vacuum tubes **408900.K** and **408910.K**.



Security screw cap containers

Ultra clear polypropylene containers with yellow polyethylene cap. They have moulded graduations in ml.

Supplied uncapped with the caps and containers in the same box.

Ideal for the pneumatic transport of liquid samples, including those that have phormaline, because they have a watertight closure. The cap, with an innovative inner shape, has a double closure. (see the figure). The base and the cap are ribbed so the handling with gloves is comfortable and reliable. There is a ring in the upper part of the body, in order to avoid the dripping in case of liquid decanting.

For other cap colours (blue, orange, magenta), ask for the minimum order quantities.

mod.	code	grad. volume ml	total volume ml	mouth Ø mm	height mm	case quantity	case weight	case volume
1	202840	20	26	34	43	1,000	8.84	0.090
2	202841	40	50	45	43	600	8.41	0.090
3	202842	60	76	45	60	500	8.00	0.110
4	202843	90	92	48	75	400	7.32	0.101
5	202848	90	108	53	68	300	6.35	0.102
6	202844	120	146	53	78	300	7.50	0.102



EUROTUBO® Leak proof screw cap containers

Specially designed for histology, they are provided with double internal security closure. Manufactured in translucent polypropylene with polyethylene ribbed yellow cap. They have moulded graduations.

Their leakproof closure makes them ideal for liquid or solid sample storage. They meet the standard UNE-EN 14401.

Rigid plastic containers. Methods to test the effectiveness of closures.

Supplied uncapped.



See more information about this product in the **chapter Histology, microscopy and staining**

Cylindrical container graduated up to 2 litres with handle

High density polyethylene container and cap. Ideal for 24 hour urine collection and any other liquid samples.

We recommend references with white and ribbed cap, that features a pharmaceutical grade liner, **which eliminates the need for an insert plug**, allows a better handling and provides a watertight seal.

Containers are graduated in 50 ml increments up to 2 l. Include a convenient handle for an easy single-handed use.

Base diameter: 108 mm.

Height, cap included: 290 mm.

Cases per pallet: 16.

Codes **408001.1** and **408001.0** are individually wrapped by retractile system.

Ask for other versions cap colours, capped containers and sterile containers.

code	body colour	cap description	presentation	individually wrapped	sterile	internal mouth Ø mm	case quantity	case weight	case volume
408001	natural	white, with liner	unscrewed	no	no	65	34	4.50	0.140
408001.0	natural	white, with liner	screwed	yes	STERILE R	65	34	4.50	0.140
408001.1	natural	white, with liner	screwed	yes	no	65	34	4.38	0.140
4080010BT	natural	black + plug	unscrewed	no	no	66.5	33	4.20	0.140
4080010/T	natural	black + plug	screwed	no	no	66.5	33	4.59	0.140
408001-86	natural	black + plug	unscrewed	no	no	86	33	4.70	0.140



Rectangular containers, graduated up to 2 litres

Containers and caps made of high density polyethylene.

Ideal for 24 hour urine collection and other liquid samples.

Containers are in translucent or brown colours and moulded graduation in 50 ml increments up to 2 l.

Ergonomically designed for single-handed use with a lateral tap of 66 mm length Height, cap included: 253 mm.

Base: 84 x 125 mm.

Cases per pallet: 16.

Models with white cap, have polyan liner, which **eliminates the need of a plug**, allows a better handling and provides a leakproof closure.

Individually wrapped models are supplied capped.

Ask for other versions: colour (both, cap or body), and sterile containers.

code	body colour	cap description	presentation	individually wrapped	sterile	internal mouth Ø mm	case quantity	case weight	case volume
407001	natural	A- white, with liner*	unscrewed	no	no	65	43	6.00	0.140
407001/T	natural	A- white, with liner*	screwed	no	no	65	43	6.00	0.140
407008	natural	A- white, with liner*	screwed	yes	no	65	43	6.40	0.140
407008.0	natural	A- white, with liner*	screwed	yes	STERILE R	65	43	6.40	0.140
4070010BT	natural	B- black + plug PE	unscrewed	no	no	66	41	5.90	0.140
4070080BT	natural	B- black + plug PE	screwed	yes	no	66	41	5.90	0.140
407003	brown	A- white, with liner*	unscrewed	no	no	65	43	6.00	0.140

* Internal joint that acts as a shutter and guarantees a tightness



Squared containers, graduated up to 2.7 l

High density polyethylene container and cap. Ideal for 24 hour urine collection and other liquid samples.

The ribbed cap features a polexan liner, which **eliminates the need for an insert plug**, allows a better handling and provides a watertight seal.

Containers are graduated in 50 ml increments up to 2.7 l.

Ergonomically designed for single-handed use.

A ring on the neck of the containers avoids dripping when pouring.

Length x width: 130 x 126 mm (± 1 mm).

Height, cap excluded: 249 mm (± 1.5 mm).

Individually wrapped models are supplied capped.

Cases per pallet: 12.



code	body colour	cap description	presentation	individually wrapped	sterile	internal mouth Ø mm	case quantity	case weight	case volume
407005	natural	white, with liner	unscrewed	no	no	64	34	5.52	0.150
407005/T	natural	white, with liner	screwed	no	no	64	34	5.52	0.150
407005.0	natural	white, with liner	screwed	yes	STERILE R	64	34	5.70	0.152
407006	brown	white, with liner	unscrewed	no	no	64	34	5.70	0.154
407006/T	brown	white, with liner	screwed	no	no	64	34	5.50	0.150



Hinged lid container

Specially designed for **milk, wine and agroalimentary oil**, although it is also suitable for other liquid or solid samples. Recommended for its use with **FOSS® and DELTA® analytical systems**, among others.

Made of **autoclavable** polypropylene. Tamper evident Lid, attached to the body by means of a hinge.

The lid is conceived to maintain 90° after its opening, enabling this pot to be used with just one hand. It has a frosted squared surface for identification. Excellent mechanical and chemical resistance.

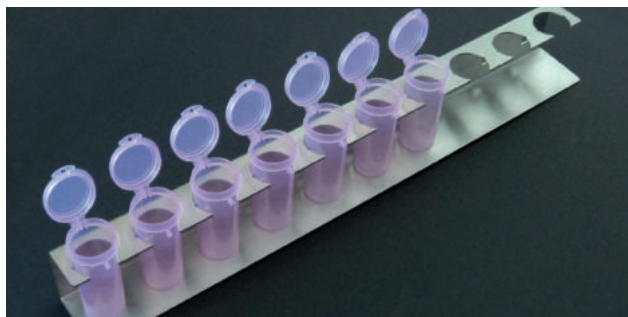
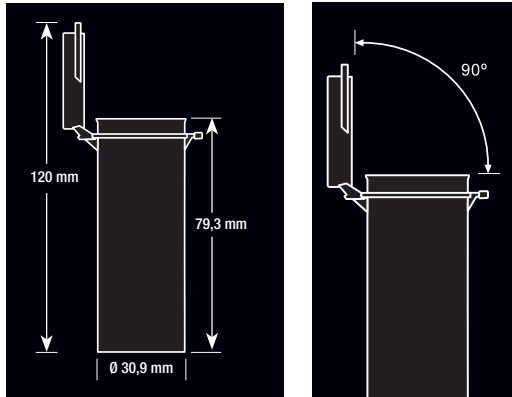

We can manufacture special racks in aluminium or stainless steel under request. Please ask the commercial department.



For coloured versions, please ask our commercial department.

code	description	case quantity	case weight	case volume	cases pallet
410046	50 ml container	800	7.5	0.140	12
410056	50 ml container individually wrapped	800	7.5	0.140	12



1. Open
2. Open at 90°
3. Closed but non tampered
4. Tampered lid
5. Untampered



Security screw cap containers

Natural colour high density polyethylene containers. Capacities: 30, 60 and 125 ml. Ideal for liquids. 60 and 125 ml containers: Bottles with screw cap, leakproof closure with child-proof system and split seal. The cap is compound by two pieces that turn around themselves avoiding the cap to be opened, working as a security closure avoiding the accidental manipulation. To open the cap push it down following the figure on the cap. The sealed caps need to be unscrewed to break the seal, showing that it has not been manipulated. 30 ml container **444603202** has a security seal, not the child-proof system closure. Pallet cases quantity: 16.

code	cap colour	body colour	height mm	Ø base mm	body weight g	case quantity	case weight	case volume
1. Capacity: 30 ml. Ø Pilfer mouth 25, security closure tamper evident								
444603202	white	natural	69.0	31.0	6.2	1.100	11.32	0.103
1. Capacity: 30 ml. Ø Pilfer mouth 28, security closure childproof system								
444603204	white	white	60.5	35.6	7.0	600	10.00	0.078
2. Capacity: 60 ml. Ø Pilfer mouth 28, security closure childproof system								
444603300	white	natural	93.7	37.6	9.5	600	11.80	0.113
444602903	white	white	93.7	37.6	9.5	600	8.00	0.110
444602901	blue	natural	87.5	37.6	9.5	600	7.50	0.110
444602801	blue	white	87.5	37.6	9.5	600	7.50	0.110
3. Capacity: 125 ml. Ø Pilfer mouth 28, security closure childproof system								
444603402	white	natural	114.8	48.0	13.6	300	5.15	0.110

We can supply other colours if required.

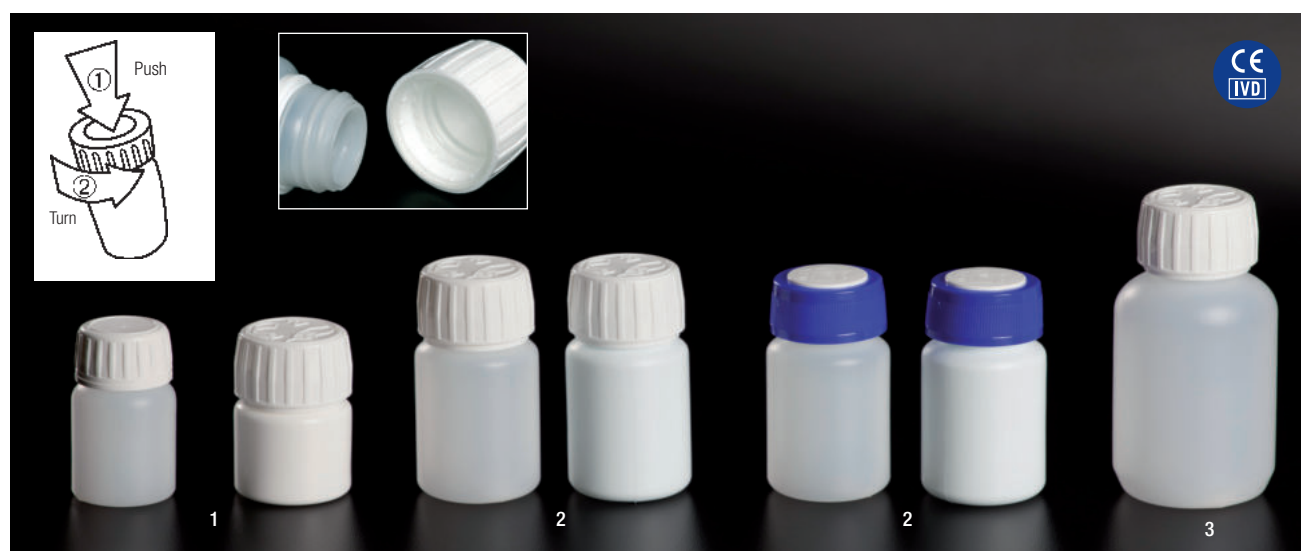

25 ml cups

Ultra clear polypropylene cup with cover in natural polyethylene, graduated up to 25 ml.

Dimensions: Ø mouth: 35 mm, Ø base: 27 mm, height 40 mm.

The cups are supplied bagged in stacks of 100 units.



See chapter
Sample storage



code	description	case quantity	case weight	case volume
430130	standard graduated cup	60 x 100	9.29	0.061
430130.1	reinforced graduated cup	60 x 100	13.00	0.065
430100.1	push cover	3 x 2,000	5.80	0.060



Characteristics of Whirl-Pak® bags

Made of a **low density polyethylene** blend, resulting in a **very resistant** and **transparent bags**. Suitable for both solid and liquid samples. The plastic thickness depends on the model (57 to 102 μ). **Hermetic closure** by rounded and flat metal rods (code 200356). Whirl-Pak® bags stand out for their unique feature: the seam of each bag is **made in one piece, which eliminates the risk of loss by the corners of the bag**. All bags (except code 200372) are **sterile by ethylene oxide**. All bags (except code 200372) are **made with materials suitable for food use**. All bags have rounded rods except code 200356 which it has flat rods. There are some codes with white bands to write.

Instructions for use of Whirl-Pak® bags



1. Tear off top of bag along perforation.
2. Use pull tabs to open bag.
3. Place sample in bag.
- 4a. Hold bag by wire ends and whirl three times to close.
- 4b. Or, fold the tab over tightly three times to close (used to close larger bags).
5. Bend wire ends onto bag.



Whirl-Pak® bags with flat wires

Same features as those from the following page but with a flat thicker wire instead of rounded wire resulting in a safer closure.

With white write-on strip.
Made with materials suitable for alimentary use.
Steriles by ethylene oxide.



1. Rounded wire
2. Flat thicker wire

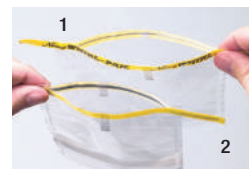

code	capacity ml	dimensions cm	thickness microns	case quantity	case weight	case volume
200356	540	11.5 x 23	64	500	2.18	0.0074



Whirl-Pak® stand-up bags

Same characteristics as Whirl-Pak® standard bags. However, they have a flat bottom which permits them to remain stand up when the sample is inside the bag. This allows to have both hands free when working so you can add or to extract the content comfortably. No need of any rack. Working as a beaker or bottle, when they are empty they take up much less space.

They have a write-on white strip.
Made with materials suitable for alimentary use.
Steriles by ethylene oxide.



code	capacity ml	dimensions cm	thickness microns	case quantity	case weight	case volume
200361	540	11.5 x 23	64	500	2.50	0.017
200365	2,070	19 x 38	102	250	4.52	0.019

Sterile Whirl-Pak® sampling bags

Suitable for both solid and liquid samples.

Leakproof closure by several metallic rounded sticks when you turn closure bands three times (see scheme).

No autoclavable. Do not use temperatures up to 82 °C.

Steriles by ethylene oxide.

Made with materials suitable for alimentary use.

Suitable for liquid nitrogen.



Without strips

code	capacity ml	dimensions cm	thickness microns	case quantity	case weight	case volume
200325	60	7.5 x 12.5	57	500	0.84	0.005
200340	120	7.5 x 18.5	57	500	1.06	0.005
200341	210	9.5 x 18	76	500	1.50	0.005
200342	390	13 x 19	76	500	2.50	0.017
200329	540	11.5 x 23	64	500	2.04	0.007
200332	720	15 x 23	76	500	2.94	0.017
200343	720	15 x 23	102	500	3.88	0.017
200345	1,080	12.5 x 38	76	500	3.90	0.017
200346	1,260	15 x 38	76	500	3.92	0.017
200347	2,070	19 x 38	76	500	5.76	0.017

Avec bande blanche pour identification

code	capacity ml	dimensions cm	thickness microns	case quantity	case weight	case volume
200326	60	7.5 x 12.5	57	500	0.78	0.005
200349	120	7.5 x 18.5	57	500	1.02	0.005
200364	390	13 x 19	64	500	2.02	0.017
200330	540	11.5 x 23	64	500	1.97	0.008
200333	720	15 x 23	76	500	3.06	0.017
200351	1,650	19 x 30	102	500	5.66	0.018
200363	2,070	19 x 38	76	500	5.54	0.019
200357	2,700	25.4 x 38	102	250	5.32	0.022
200358	3,600	25.4 x 50.8	102	250	6.46	0.022
200359	5,400	38 x 50.8	102	100	5.26	0.023



*The bags capacity is the one achieved with the closing achieved following the instructions described above and the volumes are only approximated.

Whirl-Pak® specimen transport kangaroo bag

Non-sterile bag made of a low density polyethylene blend, resulting in a **very resistant and transparent bag**.

Designed for both solid and liquid samples.

Leakproof closure with several metallic rounded sticks.

Double pouch design: one for specimen tubes and the other one for documents. It features the biohazard symbol.

Bag with a **one-piece seam**, avoiding the possible risks of the loss of the corners bags. **Suitable for liquid nitrogen.**



See blender bags in chapter **Microbiology**

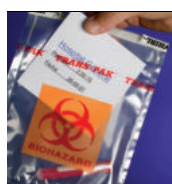

code	capacity ml	dimensions cm	thickness microns	case quantity	case weight	case volume
200372	720	15 x 23	64	500	3.38	0.017





Specimen transport kangaroo bags

For tube transport. Double pouch design: one for specimen tubes and the other for documents. Includes a safety seal.
 Reclosable (zip-lock design). Dimensions: 16x16.5 cm.
 Made of polyethylene.

code	colour	thickness My	case quantity	cases weight	case volume
V 160230	green	50	2 x 1,000	10.89	0.029
N 160230	orange	50	2 x 1,000	11.25	0.025

Zip-lock bags

Made of transparent polyethylene, very resistant to shocks and tearing. For all solid samples.
 Suitable for laboratories (for tubes, swabs, etc.) as well as industries (to contain, spare pieces, small electronic components, buttons, sweets, etc.).
Made with materials suitable for alimentary use.



code	gauge	dimensions* mm	case quantity	case weight	case volume
M 5555	200	55 x 55	2,000	1.17	0.0028
M 6080	200	60 x 80	2,000	1.41	0.0046
M 70100	200	70 x 100	2,000	1.63	0.0046
M 80120	200	80 x 120	2,000	2.64	0.0052
M 80160	200	80 x 160	2,000	2.88	0.0078
M 100150	200	100 x 150	2,000	3.96	0.0080
M 110110	200	110 x 110	2,000	3.10	0.0080
M 120180	200	120 x 180	2,000	4.64	0.0125
M 150220	200	150 x 220	2,000	7.02	0.0180
M 180250	200	180 x 250	2,000	9.16	0.0230
M 200300	200	200 x 300	2,000	11.52	0.0260
M 250330	200	250 x 330	2,000	14.91	0.0321
M 300400	200	300 x 400	1,000	12.50	0.0260

* Useful measures of the bag are contemplated.

White strip zip-lock bags

Same features as the above products.
Made with materials suitable for alimentary use.
 Feature white strip for writing for better sample identification.

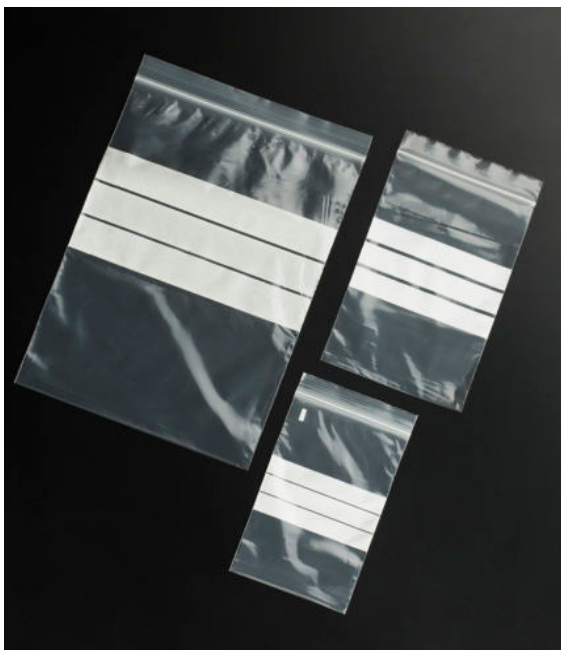

See blender bags in chapter **Microbiology**



code	gauge	dimensions* mm	case quantity	case weight	case volume
M 5555B	200	55 x 55	2,000	1.17	0.0028
M 6080B	200	60 x 80	1,000	0.70	0.0026
M 80120B	200	80 x 120	1,000	1.32	0.0038
M 70110B	200	70 x 110	1,000	0.98	0.0037
M 100150B	200	100 x 150	1,000	1.62	0.0044
M 120180B	200	120 x 180	1,000	2.40	0.0065
M 160220B	200	160 x 220	1,000	3.42	0.0099
M 180250B	200	180 x 250	1,000	4.58	0.0125
M 200300B	200	200 x 300	1,000	7.39	0.0190

* Useful measures of the bag are contemplated.

Syringes

3-piece syringes formed by body, plunger and sealing gasket. Transparent PP cylindrical body, with support fins and provided with a ring Safety that prevents accidental exit of the piston.

With an indelible graduated scale according to the International System of Measurements.

In unitary container, sterilized by ethylene oxide.

Non-pyrogenic and latex free product, PVC and Phthalates.

For version with ajuga, contact the commercial department.

code	volume	description	case quantity	case weight	case volume
JS1	1ml	3C centered luer	32 x 100	13	0.113
JS2	2ml	3C centered luer	30 x 100	13	0.113
JS3	5ml	3C centered luer	24 x 100	15	0.113
JS4	10ml	3C eccentric luer	16 x 100	15.5	0.113
JS5	20ml	3C eccentric luer	16 x 50	14	0.100
JS6	60ml	3C eccentric luer	16 x 25	16	0.120
JS8	60ml	3C catheter	16 x 25	17	0.120
JS9	100ml	3C catheter luer adapter	4 x 25	6.5	0.060



Isothermal bags

Isothermal bags for the transport of biological samples, manufactured from PEVA, PE and polyurethane (foam). The isothermal bags have two functions: keeping the temperature of samples for 6 hours while being transported, whatever the climatic conditions; protecting the samples and their contents. Available in green.

Description: for added security, isothermal bags feature three different locks: by velcro (excepting 6 l model), by zip fastener and by a coded padlock. Bags include the following elements:

- An inner pocket designed to hold the cold packs,
- A transparent outer pocket, at the front of the bag, for laboratory identification,
- A transparent pocket, over the top of the bag, to insert documents.
- Two cold packs (except **900073** which incorporates only 1) consisting of HDPE packs filled with a non toxic gel.

Before use, place cold packs in the freezer and keep at $-20\text{ }^{\circ}\text{C}/-24\text{ }^{\circ}\text{C}$ for 24 hours.

Quality features:

- Bags manufactured from sturdy and shockproof materials.
- Stand out from other isothermal bags existing on the market for their lightness and convenience.
- Offer a total security seal thanks to padlock.
- Space-saving and supplied folded in to reduce volume by 50 %.
- To clean, simply use standard detergents.
- Corners are rounded and reinforced by a double seam. Handles are sewn all around the bag for increased strength.
- Isothermal bags are traditionally manufactured (non-automated production), and each product undergoes rigid quality controls.

code	internal dimensions mm	external dimensions mm	capacity	case quantity	case weight	case volume
900073	230x230x170	200x200x150	6	1	0.63	0.004
900074	220x220x260	200x200x240	10	1	1.17	0.010
900076	390x250x280	370x230x260	27	1	1.38	0.011
900078	450x300x300	430x280x280	40	1	1.51	0.014



Bottles for water sampling

Sterile bottles, designed according to ISO standards for sampling of consumption water.

Available with thiosulfate (microbiological analysis) and without thiosulfate (physico-chemical analysis).

Bottles are available in polyethylene or PET.

Capacities vary from 500 to 1,000 ml.

Different options available:

- Personalized labels,
- Individually bagged bottles,
- Special dosifications of thiosulfate,
- Other bottles or jars from the catalogue, etc.

See more information in chapter **Microbiology**



Cytology brush

Blue ABS shaft. For cervical specimen collection, designed for taking cell samples without damaging them.

Includes a soft tip to provide more comfort for patients.

Total length: 19.5 cm.

Sterile model is sterilised by ethylene oxide and includes instructions.



code		description	case quantity	case weight	case volume
440150		non sterile	50 x 50	3.55	0.009
440151	STERILE EO	individual peel-pack	2 x 500	3.23	0.029



Vaginal speculum

Manufactured in transparent polystyrene. Handle design that allows one-handed quick and convenient manner. Zip system for opening and closing. Aseptic. Rounded edges and ergonomically designed for single-handed use. Free of heavy materials as CE/94/62 directive.

Packaged individually with a peel-pack that facilitates the traceability and also indicates expiration date.

Available in 3 different sizes.



code	dimensions mm	case quantity	case weight	case volume
440157	17	100	3.89	0.060
440158	30	100	4.10	0.060
440159	33	100	4.62	0.060



AYRE wood spatula

Rounded edges.

Sterile model is sterilised by **ethylene oxide** and includes instructions.

Total length 178 ± 5 mm.



code		description	case quantity	case weight	case volume
440142.0		non sterile	50 x 100	10.00	0.025
444150	STERILE EO	individual peel-pack	2 x 500	5.10	0.029



AYRE plastic spatula

Made of **autoclavable** polypropylene.

Rounded edges.

Sterile model is sterilised by **ethylene oxide** and include instructions.

Total length 179 ± 1 mm.



code		description	case quantity	case weight	case volume
440142		non sterile	5 x 500	7.00	0.025
444142	STERILE EO	individual peel-pack	2 x 500	4.60	0.029
444242	STERILE EO	individual flow-pack	2 x 500	4.60	0.029

Minimum ordering quantity: 500.







TUBES, MICROTUBES AND CRYOVIALS

 deltalab

Round bottom polystyrene tubes

Manufactured from high technology, new generation moulds to ensure the reproducibility of each tube. Tubes are made in one piece to ensure uniformity and dimensional accuracy from tube to tube.

mod.	code	dimensions mm	volume ml	case quantity	case weight	case volume	cases per pallet
1	300500	11 x 55	3	2 x 2,000	6.50	0.046	32
2	300300	11 x 70	4	3 x 1,000	6.20	0.045	32
3	300800*	12 x 75	5	4 x 1,000	9.52	0.075	20
4	300800.2	12 x 75 thick wall	5	4 x 1,000	10.70	0.075	20
5	300800.1	12 x 75	5	4 x 1,000	9.75	0.072	20
6	300400*	12 x 88	6	4 x 1,000	11.30	0.082	20

*Codes with graduation rings.

Code 300800 (mod. 3) is graduated at 1, 2.5 and 4 ml. Code 300400 (mod. 6) is graduated at 1, 2.5 and 5 ml.

Suitable for centrifugation up to 7,500 xg.

All tubes are suitable for laboratory use.

A complete range of test tube caps is detailed on page 147 of this catalogue.

Dimensions (± 0.09)

code	internal diameter mm	external diameter mm	total length mm	maximum volume ml
300500	10	11.5	54.4	3.5
300300	9.1	10.8	69.4	4.0
300800	10.3	11.8	74.5	5.5
300800.1	10.2	11.8	74.5	5.5
300800.2	10	11.8	74.5	5.3
300400	10.4	12	87.6	5.9

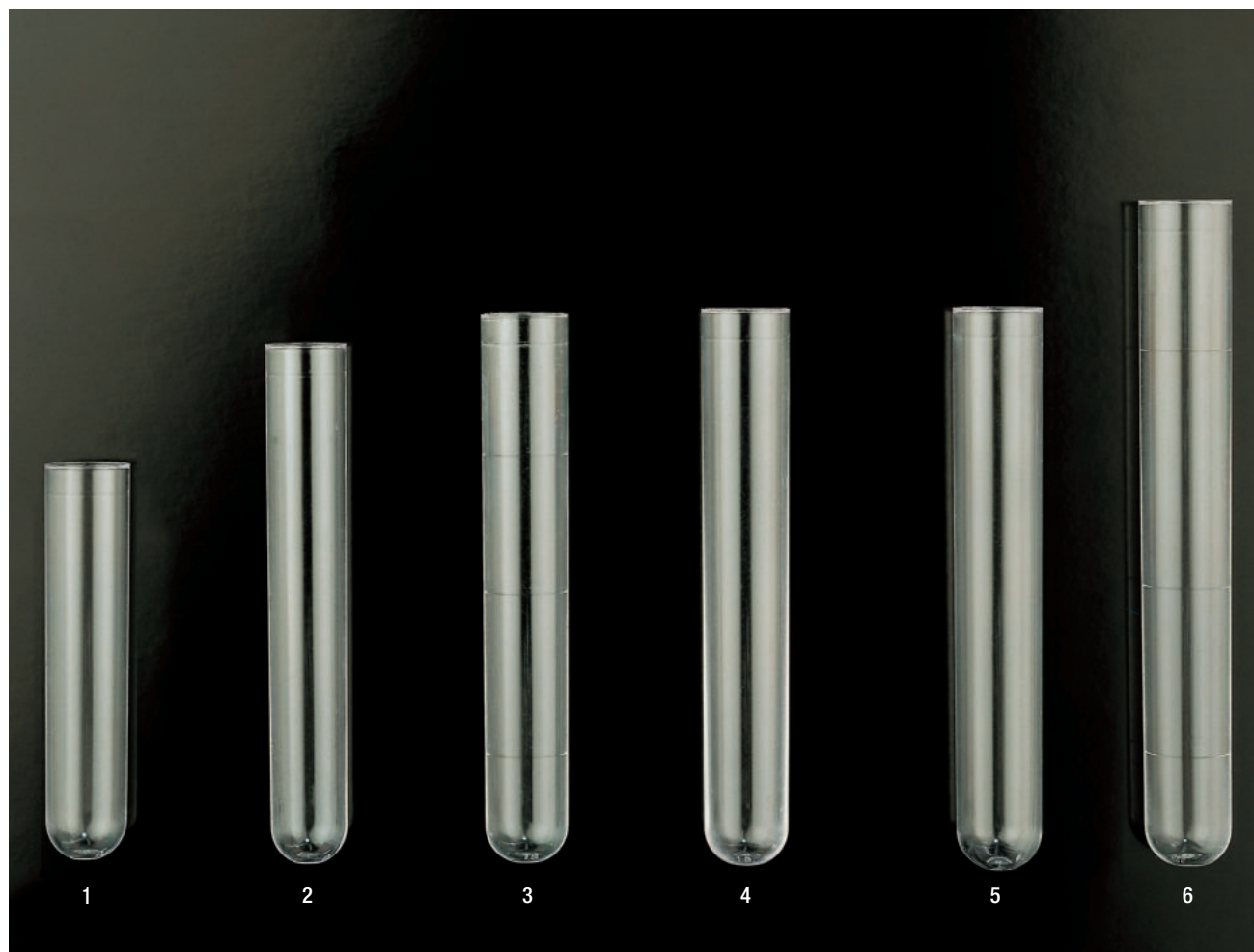

Round bottom polystyrene tubes

Manufactured from high technology, new generation moulds to ensure the reproducibility of each tube. Tubes are made in one piece to ensure uniformity and dimensional accuracy from tube to tube.

mod.	code	dimensions mm	volume ml	case quantity	case weight	case volume	cases per pallet
1	300700	13 x 75	5	4 x 1,000	13.04	0.082	20
2	301700	13 x 100	7	6 x 500	11.24	0.084	20
3	300900*	16 x 95	10	5 x 500	12.10	0.096	16
4	300705	16 x 100	10	5 x 500	15.00	0.110	16
5	300100	16 x 150	17	1,000	9.84	0.093	20

*Code with graduation rings at 2.5, 5 and 10 ml.

Dimensions (± 0.09)

code	internal diameter mm	external diameter mm	total length mm	maximum volume ml
300700	10.9	12.9	74.7	6.7
301700	11.0	12.9	99.6	8.3
300900	13.8	15.8	94.6	12.2
300705	13.8	16.0	99.8	13.2
300100	14.6	16.3	151.0	21.1

Suitable for centrifugation up to 7,500 xg.

All tubes are suitable for laboratory use (excepting code **300100**, which does not withstand centrifugation).

A complete range of test tube caps is detailed on page 147 of this catalogue.



Ultra clear polypropylene round bottom tubes

Manufactured from high technology, new generation moulds to ensure the reproducibility of each tube.

Tubes are made in one piece to ensure uniformity and dimensional accuracy from tube to tube.

Autoclavable up to 121 °C.

mod.	code	dimensions mm	volume ml	case quantity	case weight	case volume	cases per pallet
1	400500	11 x 55	3	2 x 2,000	6.50	0.045	32
2	400800*	12 x 75	5	4 x 1,000	8.00	0.075	20
3	400800.1	12 x 75	5	4 x 1,000	8.00	0.075	20
4	400700	13 x 75	5	4 x 1,000	11.15	0.082	20
5	400400*	12 x 88	6	4 x 1,000	9.60	0.082	20
6	401700	13 x 100	7	6 x 500	9.40	0.082	20
7	400900*	16 x 95	10	5 x 500	10.10	0.096	16
8	400705	16 x 100	10	5 x 500	12.20	0.096	16
9	401100*	15 x 50	5	5 x 1,000	10.40	0.082	20

*Codes with graduation rings.

400800 (mod. 2): graduated at 1, 2.5 and 4.0 ml; code 400400 (mod. 5): graduated at 1, 2.5 and 5.0 ml; 400900 (mod. 7): graduated at 2.5, 5 and 10 ml; 401100 (mod. 9): graduated at 2.5 and 5 ml.

Suitable for centrifugation up to 15,000 xg.

All tubes are suitable for laboratory use.

A complete range of test tube caps is detailed on page 147 of this catalogue.

Dimensions (±0.09)

code	internal diameter mm	external diameter mm	total length mm	maximum volume ml
400500	9.9	11.4	53.9	3.4
400800	10.3	11.7	73.9	5.3
400800.1	10.2	11.7	73.9	5.3
400700	10.9	12.7	73.7	6.4
400400	10.3	11.9	86.9	5.8
401700	11.0	12.7	98.4	8.1
400900	13.7	15.5	93.7	11.9
400705	13.7	15.8	98.6	12.7
401100	13.7	15.5	48.9	6.5

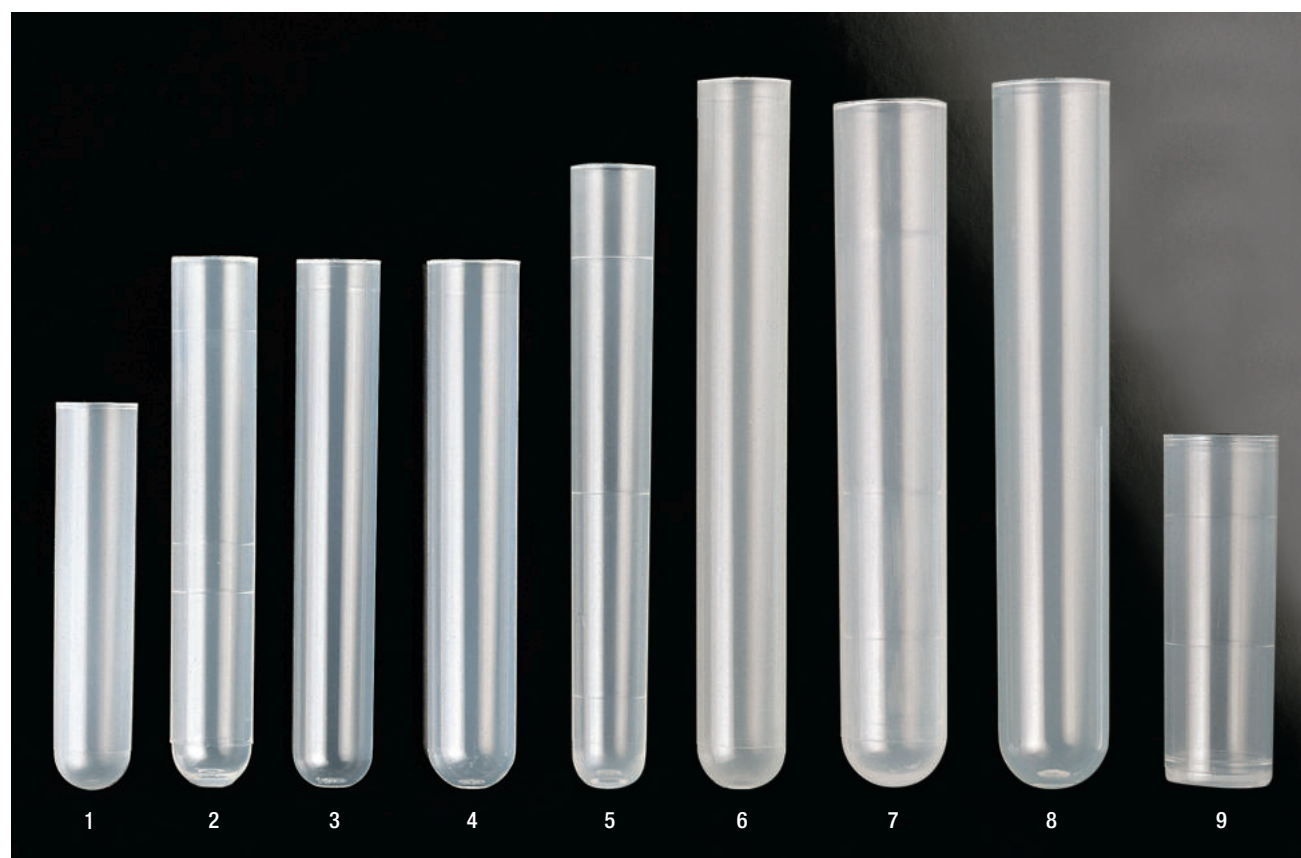

Polystyrene round bottom tubes capped

Volume:

- code 300702: 5 ml.
- code 300903: 10 ml.
- code 300907: 11 ml.

Suitable for centrifugation up to 7,500 xg.



mod.	code	dimensions tube mm	height tube + cap mm	case quantity	case weight	case volume	cases pallet
1	300702	13 x 75	83.4	2 x 1,000	7.92	0.045	32
2	300903	16 x 95	105.2	4 x 500	13.00	0.110	48
3	300907	16 x 100	109.6	4 x 500	15.41	0.110	12

Components :

mod.	code	tube	cap
1	300702	300700	+ 307107
2	300903	300900	+ 308107
3	300907	300705	+ 308107



Polystyrene round bottom tubes, capped and labelled

Volume:

- code 300704: 5 ml.
- code 300904: 10 ml.
- code 300908: 11 ml.

Dimensions of the label: 35 x 25 mm.

Suitable for centrifugation up to 7,500 xg.



mod.	code	dimensions tube mm	height tube + cap mm	case quantity	case weight	case volume	cases pallet
1	300704	13 x 75	83.4	2 x 1,000	7.50	0.046	40
2	300904	16 x 95	105.0	4 x 500	13.00	0.110	48
3	300908	16 x 100	110.4	4 x 500	14.00	0.110	16

Components :

mod.	code	tube	cap	label
1	300704	300700	+ 307107	+ ✓
2	300904	300900	+ 308107	+ ✓
3	300908	300705	+ 308107	+ ✓

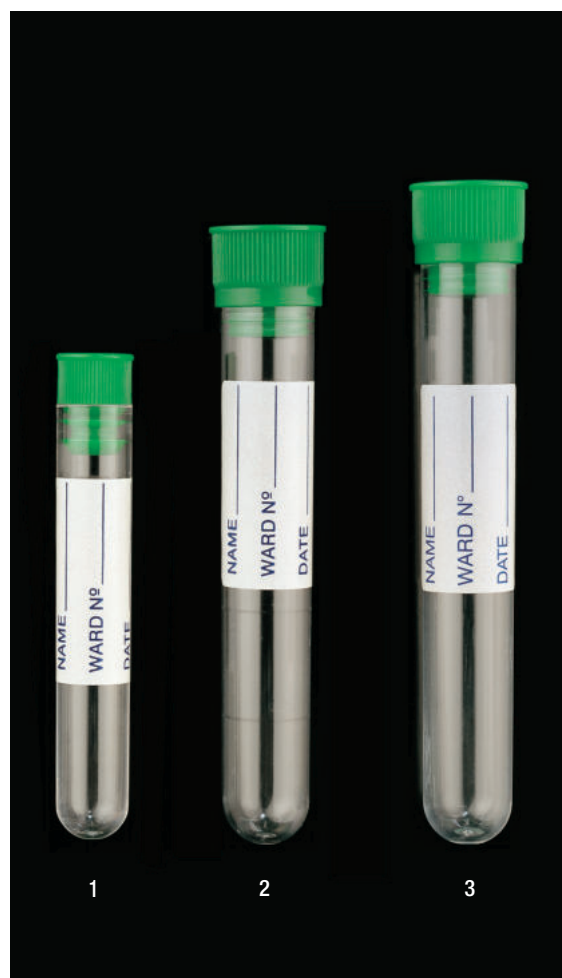

See chapter Containers. Sampling

Conical tubes

Manufactured in polypropylene (PP) and polystyrene (PS).

mod.	code	autoclavable	dimensions mm	material	volume ml	case quantity	case weight	case volume	cases per pallet
1	301200*		16 x 102	PS	12	5 x 500	12.92	0.096	16
2	401200*	✓	16 x 102	PP	12	5 x 500	10.60	0.096	16
3	301213		17 x 105	PS	12	1,500	8.80	0.088	20
4	301212		17 x 105	PS	12	1,500	8.80	0.088	20
5	301201		16 x 100	PS	12	5 x 500	12.63	0.096	16
6	401201	✓	16 x 100	PP	12	5 x 500	10.75	0.096	16
7	301202		16 x 102	PS	12	5 x 500	12.90	0.096	16
8	401204*	✓	16 x 100	PP	12	5 x 500	10.20	0.096	16

* Codes with internal graduations.

Codes **301213** (mod. 3) and **301212** (mod. 4) are flared at their top for easy pouring and have a special sedimentation base.

Codes **301200** (mod. 1), **401200** (mod. 2) and **301202** (mod. 7) have an external rim.

All models are suitable for centrifugation.
 PS tubes: **7,500 xg**; PP tubes: **15,000 xg**.
 Except code **301212** and **301213** to **3,000 xg**.

Dimensions (±0.09)

code	internal diameter mm	external diameter mm	total length mm	maximum volume ml
• 301200	14.5	19.1/16.4	100.8	12.9
• 401200	14.4	18.8/16.2	99.8	12.5
• 301213	15.4/19.2	17.1/19.2	105.1	16.5
• 301212	15.4/19.2	17.1/22.0	105.0	16.4
301201	14.5	16.4	99.5	12.9
401201	14.4	16.2	98.4	12.5
• 301202	14.5	19.1/16.4	100.8	12.9
401204	14.4	16.2	98.4	12.5

• External diameter of the rim.



PP
mod. 2, 6, 8

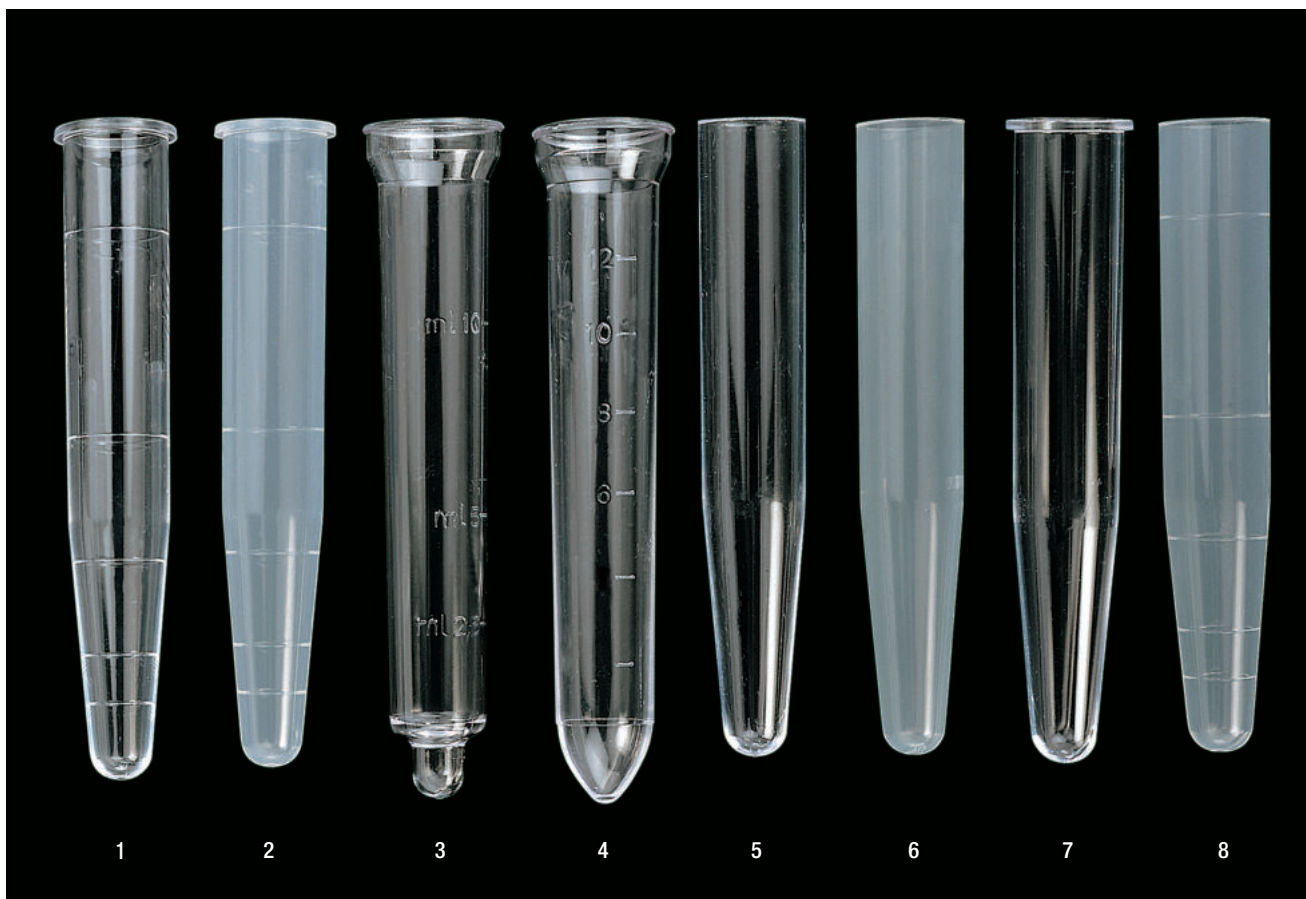

Bouchons polyéthylène

mod.	code	to fit tubes	yellow	natural	brown	malve	blue	green	red	black	bag quantity	bag weight	bag volume
			(to add at the end of the code)										
1	3053	300500, 400500, 300800.2		02	03	08		07	06		2 x 2.000	1.60	0.009
2	3058	300800, 400800, 300800.1, 300400, 400400, 400800.1		02		08	05	07	06	09	2.000	1.76	0.007
3	3071	300700, 301700, 400700, 401700, 300701, serie 300700.6	01	02		08	05	07	06	09	2.000	1.50	0.007
4	3072	300705, 300900, 400705, 400900, 401100, 300707		02			05	07	06		2.500	3.00	0.018
5	3050	300705, 300900, 400705, 400900, 401100, 300907, 300904, 300908		02		08		07			2.500	3.26	0.019
6	3081	300705, 300900, 400705, 400900, 401100, 300707, 300907, 300904, 300908		02				07	06		2.500	5.00	0.023
7	3070	300100							06		1.000	1.20	0.012
8	3055	301201, 401201, 301200, 401200, 301202, 401204		02				07			2.500	4.00	0.018
9	3082	301201, 401201, 401204		02			05				2.500	5.10	0.023
10	3066	301213, 301212	01								1.500	1.28	0.012

Ask for other colours.



mod.	code	recommended tubes	colour	bag quantity	bag weight	bag volume
NEW 11	705722	300705, 300900, 400705, 400900, 401100	red	1.000	1,08	0,096
NEW 12	701061	300800, 300801	green	1.000	0,70	0,003
NEW 13	701034	300300	natural	1.000	0,66	0,003
NEW 14	705595	300500, 300800.2	red	1.000	0,70	0,003

Ask for other colours.

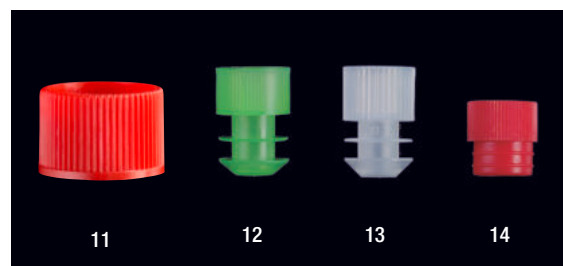

Re-caps

Ideal for re-capping blood collection tubes «vacuum type». Suitable for other glass and plastic tubes. Manufactured in flexible polyethylene. Easy to cap and remove.

Please find racks for these tubes on chapter **Sample Storage**



code	description	bag quantity	bag weight	bag volume
308502	Ø 12-13 mm natural colour	6 x 1,000	1.70	0.025
308506	Ø 12-13 mm red colour	6 x 1,000	2.18	0.025
308602	Ø 15,2-16 mm natural colour	6 x 1,000	1.70	0.025
308606	Ø 15,2-16 mm red colour	6 x 1,000	2.18	0.025

Other colours available on request, minimum order quantity is 6,000 units.

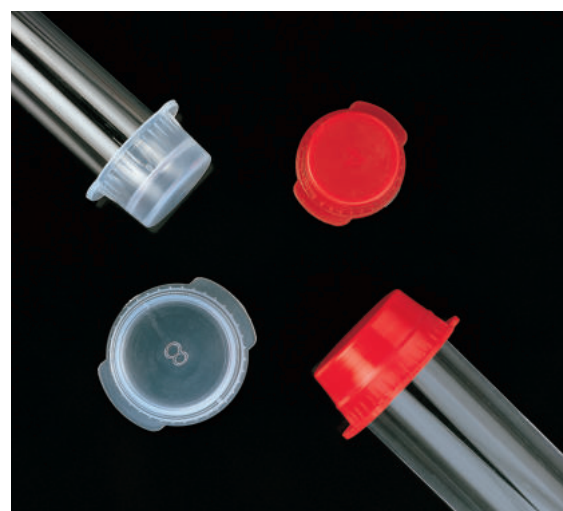

General features of our caps



Includes an internal chamber for more liquid filling, thus compensating for the loss of space inside the tube caused by the insertion of a cap.



code	internal diameter mm	external diameter mm	total length mm
3050	13.95	19.30	13.15



Includes a small internal chamber. Light-weighted. Ergonomical. Ribbed for a better handling while using gloves.



code	internal diameter mm	external diameter mm	total length mm
3053	10.00	11.85	11.30



Those three flange plug caps present significant advantages over other flange caps existing on the market.

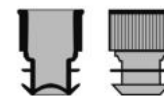

code	internal diameter mm	external diameter mm	total length mm
3055	14.50	17.05	21.77
3072	15.40	17.00	21.60
3071	11.25	13.30	17.40



Light-weighted. Includes a lifting tab for easy opening.



code	internal diameter mm	external diameter mm	total length mm
3066		23.30	5.90



Includes a small internal cavity designed to prevent possible drop spillage. Ergonomical. Ribbed for a better handling while using gloves.



code	internal diameter mm	external diameter mm	total length mm
3058	10.60	15.00	15.30



Ribbed for a better handling while using gloves. No chamber. Leakproof. Includes four internal rims to clamp firmly on tube.

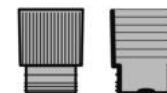

code	internal diameter mm	external diameter mm	total length mm
3070	14.90	19.20	25.35



One of the caps offering the largest chamber on the market, thus compensating for the loss of space inside the tube caused by the insertion of a cap.



code	internal diameter mm	external diameter mm	total length mm
3081	13.80	19.68	19.00



It has the same characteristics than the previous cap.



code	internal diameter mm	external diameter mm	total length mm
3082	14.55	20.45	18.50

EUROTUBO® 12 ml screw cap tubes, round bottom

Made of **autoclavable** (121 °C) transparent polypropylene or polystyrene. Green cap made of high density polyethylene. Dimensions: 15 x 102 mm. The external skirt allows the tubes to remain **free-standing**. Supplied screwed. Recommended volume: 12 ml. The sterile model (ethylene oxide) is supplied individually in flow-pack bag, with indication of batch, expiration date, etc. According to the guidelines for sterile products.

Attention: For autoclaving, the cap should be loose on the thread and not tightly fitted.

Dimensions (±0,09):

code	external cap Ø mm A	external tube Ø mm B	internal tube Ø mm C	length with cap mm D	length without cap mm E
301402, 301403	20.9	16.3	14.4	103.9	102.5
401402, 401403	20.9	16.2	14.3	102.9	101.5

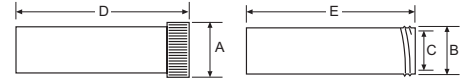

mod.	code	description	autoclavable	sterile	maximum volume ml	volume recom. ml	case quantity	case weight	case volume	cases pallet
1	301403	polystyrene		no	14.4	12	6 x 250	12.90	0.082	20
2	301402	polystyrene individually wrapped		STERILE EO	14.4	12	6 x 250	13.40	0.096	16
3	401402	polypropylene individually wrapped	✓	STERILE EO	14.2	12	6 x 250	12.03	0.096	16
4	401403	high transparency polypropylene	✓	no	14.2	12	6 x 250	11.11	0.082	20

Resistance to centrifugation:
PS: 7,500 xg. PP: 15,000 xg.



Sterile culture tubes in polystyrene

Tubes supplied with either a two position ribbed polyethylene cap, which can be left loose for aerobic work or sealed for anaerobic cultures. They are biologically inert, exempt from mold release agents, and withstand up to **70 °C**. Packaged in self-standing resealable zip-lock bags of 125 units.

Resistance to centrifugation: 1,400 xg



Loose position for aerobic work



Sealed position for anaerobic cultures

code	dimensions mm	case quantity	case weight	case volume	volumen caja
300807	12 x 75	5	8 x 125	4.24	0.033
300808	17 x 100	14	8 x 125	7.14	0.060



15 ml and 50 ml centrifugal tubes

Made of polypropylene, suitable for both clinical and research applications. **DNAsa, RNAsa, human DNA and endotoxins.** They are also free from natural rubber and heavy metals. High transparency of the material for a clear visualization during experiments specially for molecular biology and animal tissue culture.

Tube and cap designed with the system of flat threads for a complete leakproof. Highly smooth hydrophobic surface for minimum disturbance during centrifugation. Silk-screen blue graduation in the tube and large white frosted portion for easy writing.

Autoclavable at 121 °C.

Centrifugation resistance: **14.000 xg**, except code **429931: 7.500 xg** and codes **429950, 429951: 3.500 xg**

It is recommended to use adapters to centrifuge and avoid malformations.

Available models: 15 ml non-skirted and 50 ml skirted and non-skirted.

15 ml tubes		50 ml tubes	
∅ Exterior: 16,5	∅ Interior: 121	∅ Exterior: 16,5	∅ Interior: 121

It is recommended that the centrifuge caps fit in size and shape to the tubes to be centrifuged.

code	description	presentation	sterile	case weight	case volume	cases per pallet
15 ml tubes						
429940	non-skirted tube	500 tubes in bulk	no	500	4.50	0.034
429945	non-skirted tube	20 bag to 25 tubes	no	500	4.50	0.0281
429942	non-skirted tube	20 bag to 25 tubes	STERILE R	20 x 25	4.02	0.04
50 ml tubes						
429930	non-skirted tube	20 bag to 25 tubes	no	500	7.70	0.09
429931	non-skirted tube	20 bag to 25 tubes	STERILE R	20 x 25	7.44	0.108
429950	non-skirted tube	20 bag to 25 tubes	no	500	8.80	0.09
429951	non-skirted tube	20 bag to 25 tubes	STERILE R	20 x 25	8.80	0.108



15 ml and 50 ml conical high resistance tubes. Sterile

Tubes made of transparent, copolymer polypropylene. Green caps made of polyethylene with an internal liner which ensures leakproofness.

Tubes feature a solvent resistant white panel and black graduations for use both for clear or dark samples. **DNase, RNase, endotoxins and metal free.** They are **sterile by radiation** and withstand temperatures down to **-90 °C** (15 ml) and **-80 °C** (50 ml). Resistance to centrifugation: **17,000 xg** (15 ml) and **20,000 xg** (50 ml). Autoclavable tube (the liner of the cap is not autoclavable)

Supplied in bags of 50 units.

Bags are printed with instructions for use and feature a double closure: a first tamper evident seal that helps guaranteeing sterility, and a secondary zip-lock, resealable closure.

	code	presentation	capacity ml	dimensions mm	case quantity	case weight	case volume
1	409920	bag 50 units	15	17 x 118	10 x 50	3.90	0.035
2	409922	bag 50 units	50	29.6 x 114.6	10 x 50	8.07	0.076

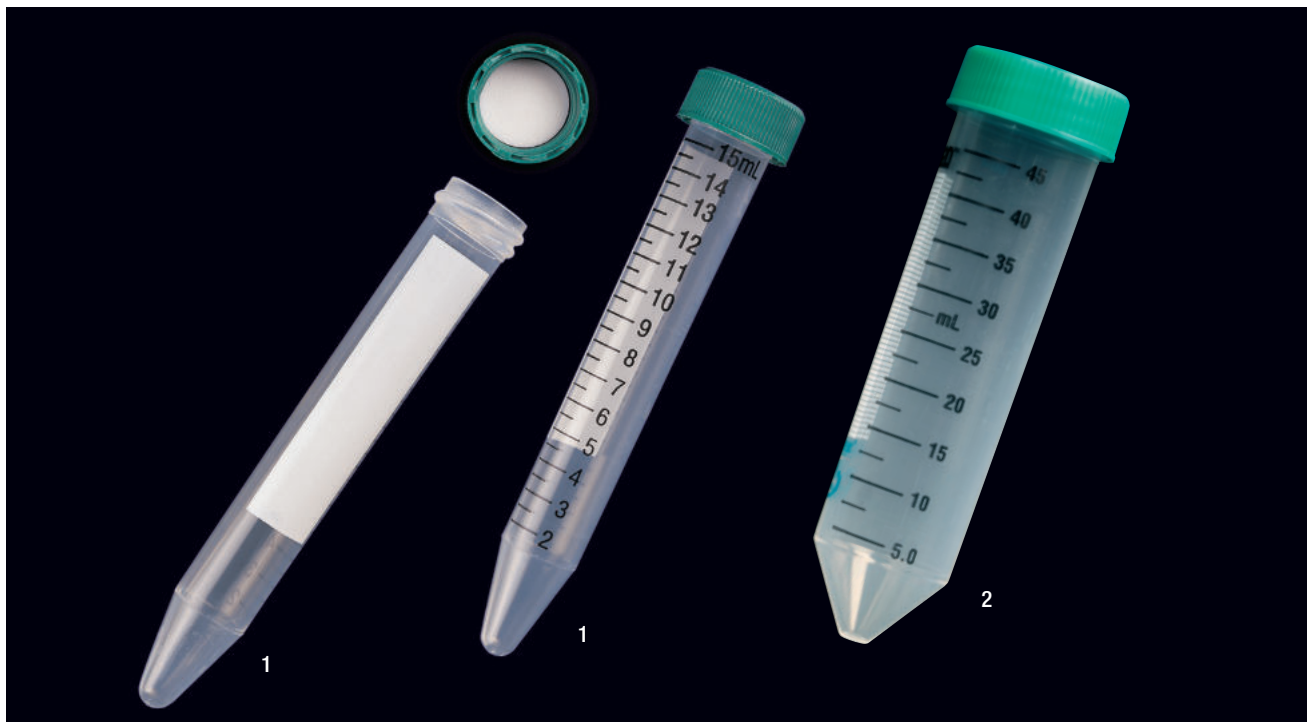

5 and 10 ml freestanding, conical bottom tubes

Freestanding tubes with screw caps. Conceived for sampling, transport and midterm storage. Feature molded graduations at 1 ml increments and a large surface for labeling and identification. Round bottom tubes made of **autoclavable** polypropylene, leakproof caps made of polyethylene.

Withstand temperatures between **121 °C** and **-40 °C**.

Certified to the **IATA 95kPA** standard for safe shipping of samples transport by air.



Dimensions (±0,5):

code	external cap Ø mm	internal tube Ø mm	length with cap mm	length without cap mm
439905	15.8	14.17	60.20	58.62
439910	15.8	14.17	94.74	92.96

code	description	case quantity	case weight	case volume
439905	5 ml PP thread tube	500	2.72	0.016
439910	10 ml PP thread tube	2 x 500	6.35	0.055



EUROTUBO® 15 ml and 50 ml conical tubes

Tubes made of transparent polypropylene, conical bottom. Suitable for centrifugation tests in immunology laboratories, microbiology, etc.

With continuous thread and molded external graduation each 0.5 ml in 15 ml tubes, and each 5 ml in 50 ml tubes.

Blue polyethylene cap with internal elastic obturation to assure an hermetical closure.

Resistance to centrifugation:

15 ml tubes, non sterile models until **7.000 xg**, sterile models **5.000 xg**. The 15ml tubes have a matt area.

50 ml tubes, non sterile models until **12.000 xg**, sterile models **7.000 xg**.

Sterile models are not suitable for autoclaving.

Non sterile models are **autoclavable at 121 °C**, with the cap positioned on the thread but uncapped.

50 ml tubes have skirted and non skirted models.

code	description	sterile	external cap Ø mm	internal tube Ø mm	external tube Ø mm	length with cap mm	case quantity	case weight	case volume	cases per pallet
15 ml conical tubes										
429910	non sterile	no	20.9	14.35	17	120	500	3.94	0.030	54
429920	100 units in bag	STERILE R	20.9	14.35	17	120	5 x 100	3.90	0.029	54
429946	individually bagged	STERILE R	20.9	14.35	17	120	500	3.96	0.040	40
50 ml conical tubes										
429900	non skirted	no	34.4	27.2	29.5	117.5	500	7.80	0.072	20
429900SP	non skirted, unscrewed cap	no	34.4	27.2	29.5	117.5	500	7.90	0.082	20
429901	skirted	no	34.4	27.2	29.5	117.5	500	8.50	0.082	20
429926	non skirted, individually wrapped	STERILE R	34.4	27.2	29.5	117.5	500	8.00	0.080	20
429926.25	non skirted, bag 25 units	STERILE R	34.4	27.2	29.5	117.5	20x25	8.30	0.082	20
429926.10	non skirted, bag 100 units	STERILE R	34.4	27.2	29.5	117.5	5x100	7.90	0.082	20
429927	skirted, individually wrapped	STERILE R	34.4	27.2	29.5	117.5	500	8.80	0.082	20
429927.25	skirted, bag 25 units	STERILE R	34.4	27.2	29.5	117.5	20x25	8.80	0.082	20
429927.10	skirted, bag 100 units	STERILE R	34.4	27.2	29.5	117.5	5x100	8.50	0.082	20

It is recommended that the centrifuge caps fit in size and shape to the tubes to be centrifuged.



GLASS TUBE RANGE

The high quality of our range of disposable glass culture tubes and screw threaded tubes is reflected in the uniformity of their wallthickness, shape of their bottoms, close tolerances, well formed bottoms and well moulded screw-neck. All of our tubes are fully annealed at temperatures above **500 °C** to eliminate contamination, reduce breakage and increase strength. The majority of our tubes are packaged in plain outer cases. Each tube is polished individually.

Culture tubes:

They are available in either borosilicate or soda lime glass. Both glasses differ primarily in their chemical composition and their chemical resistance.

Borosilicate glass is a type of glass with a higher resistance to thermal shock. For this reason borosilicate glass is more suitable when tubes are intended to be heated or cooled rapidly.

Soda lime glass is a more economical alternative and suits for most culture medium, bacteriological and laboratory applications where the tube will not be subjected to extreme temperature changes.

Screw-neck tubes are ideal for tissue culture and general bacteriological work. Tubes are supplied with standard GPI finishes.

The screw – neck vials are made of borosilicate glass and are basically used for diagnosis, pharmaceuticals, chemicals, laboratory analysis, storage of liquids and powders. The caps presented are manufactured in autoclavable polypropylene with internal silicone joint.

Different packagings are available, depending on the model of tube:

Boxes: sturdy cardboard boxes. Each box contains small shrink-wrapped cases. Tubes are presented horizontally.

Trays: sturdy shrink-wrapped cardboard trays. Tubes are presented vertically.



Pressure cap for glass tubes

Made of polypropylene, **autoclavable up to 121 °C**.
Recommended for glass tubes.
Codes **916100, 816100, 916150, 816150** and **816160**.
Vented caps (with inner flats).



code	recommended for tubes Ø mm	colour	case quantity	case weight	case volume
617402	16	naturel	4 x 1,000	5.15	0.059

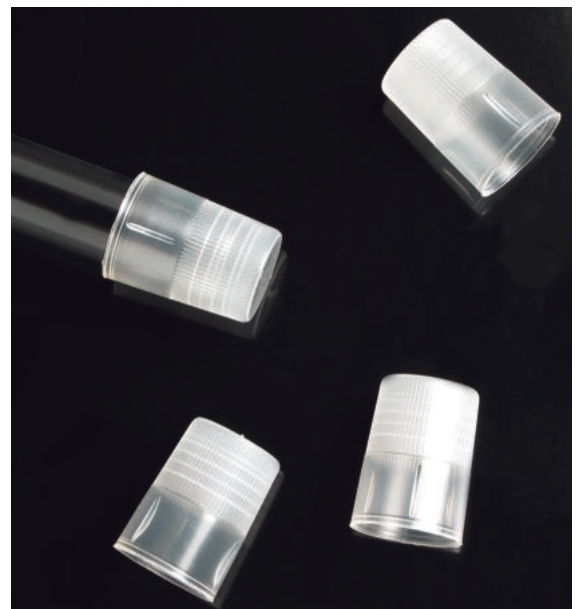

Round bottom glass tubes

Made of **borosilicate** or **soda glass**.

The high quality of those tubes is reflected in the uniformity of their wall thickness and of their diameter and height dimensions.

Supplied in small quantities per case for a more convenient use in laboratory.

Soda tubes

code	total capacity ml	Ø int. mm tube	Ø ext. mm tube	height mm	thickness mm	case quantity	case weight	case volume
Supplied in boxes (1)								
801075	4	8.20	9.75	75	0.60	4 x 250	3.60	0.010
801275	6	10.20	11.60	75	0.60	4 x 250	4.50	0.013
813100	10	11.10	12.70	100	0.60	4 x 250	6.59	0.022
816100	15	13.95	15.75	100	0.60	4 x 250	9.46	0.034
816150	22	13.55	16.00	150	0.70	4 x 250	13.22	0.049
816160	27	14.40	16.00	160	0.55	500	5.50	0.018
818150	28	15.00	18.00	150	0.85	2 x 250	7.30	0.030
820150	34	17.20	20.00	150	0.85	100	1.92	0.006
820200	47	17.15	19.25	200	0.85	250	6.30	0.020
Supplied in trays (2)								
801175T	6	10.10	11.60	75	0.50	550	1.86	0.005

Boro tubes

code	glass type	total capacity ml	Ø int. mm tube	Ø ext. mm tube	height mm	thickness mm	case quantity	case weight	case volume
Supplied in boxes (1)									
901075	Boro 5.1	4	8.20	9.75	75	0.60	4 x 250	3.60	0.010
901275	Boro 5.1	6	10.20	11.60	75	0.60	4 x 250	4.50	0.014
913100	Boro 5.1	10	11.10	12.70	100	0.60	4 x 250	5.92	0.022
916100	Boro 5.1	15	13.95	15.75	100	0.60	4 x 250	9.10	0.034
916150	Boro 5.1	22	13.55	16.00	150	0.70	4 x 250	13.60	0.049
918150	Boro 5.1	28	15.00	18.00	150	0.85	4 x 125	7.30	0.040



Screw threaded glass tubes

Made of **borosilicate** or **soda glass**. The high quality of those screw threaded tubes is reflected in the uniformity of their wall thickness and of their diameter and height dimensions. Supplied in small quantities per case for a more convenient use in laboratory. Tubes are supplied without caps. To order caps see below. Polypropylene caps are designed for the round bottom tubes. Aluminium caps are designed for flat bottom tubes.

Soda glass tubes

code	total capacity ml	screw	Ø int. mm tube	Ø ext. mm tube	height mm	thickness mm	case quantity	case weight	case volume	suitable cap
Flat bottom soda glass tubes supplied in trays										
617145	24	CAPALU 16	14.20	17.75	144.5	1.05	252	5.54	0.010	617000

Borosilicate glass tubes

code	glass type	total capacity ml	screw	Ø int. mm tube	Ø ext. mm tube	height mm	thickness mm	case quantity	case weight	case volume	suitable cap
Round bottom tubes, supplied in boxes.											
713100	Boro 5.1	5	13 - 415	10.65	12.75	100	1.00	4 x 250	9.56	0.021	617100
716100	Boro 5.1	11	15 - 415	14.00	16.00	100	1.05	4 x 250	12.36	0.033	617200
716125	Boro 5.1	14	15 - 415	14.00	16.00	125	1.05	4 x 250	14.91	0.045	617200
716150	Boro 5.1	18	15 - 415	14.00	16.00	150	1.05	4 x 250	17.42	0.047	617200
720150	Boro 3.3	34	18 - 415	17.70	20.00	150	1.15	4 x 125	11.80	0.036	617300



Screw caps for the above tubes

For round bottom borosilicate glass tubes, choose **polypropylene caps (black colour)**. For flat bottom soda glass tubes, choose **aluminium** caps, with an internal liner made of caoutchouc. Code **617000** incorporates a polypropylene gasket. Pharmaceutical quality.

Both models of caps are fully **autoclavable**.

code	suitable tube	type of cap	bag quantity	bag weight	bag volume
617000*	617145	aluminium	500	0.76	0.003
617100	713100/617145	polypropylene	1,000	0.86	0.005
617200	716100 / 716125 / 716150	polypropylene	1,000	1.50	0.007
617300	720150	polypropylene	500	1.03	0.012

* Carry polypropylene gasket.



Flat bottom screw threaded vials

Made of ultra clear borosilicate glass. Fully **autoclavable**.

Supplied in trays individually shrink-wrapped. Thickness: 1 mm. Caps are supplied separately. To order caps see below.

mod.	code	glass type	dimensions mm	volume ml	screw	tray quantity	tray weight	tray volume	suitable cap
1	900204	Boro 5.1	15 x 45	4	13-425	100	0.40	0.0010	917000
2	900205	Boro 4.9	18 x 50	5	15-425	250	1.82	0.0042	918000
3	900211	Boro 5.1	22 x 48	10	18-400	100	0.94	0.0024	922000
4	900212	Boro 5.1	19 x 65	12	18-400	100	1.10	0.0020	922000
5	900220	Boro 4.9	28 x 65	20	22-400	2 x 150	2.70	0.0100	928000
6	900225	Boro 5.1	28 x 70	24	22-400	100	1.52	0.0057	928000

Caps for the above vials

Made of **autoclavable** polypropylene. Black caps feature an internal silicone joint.

mod.	code	screw	bag quantity	bag weight	bag volume
A	917000	13-425	100	0.11	0.0003
B	918000	15-425	250	0.32	0.0006
C	922000	18-400	250	0.53	0.0026
D	928000	22-400	300	0.98	0.0062

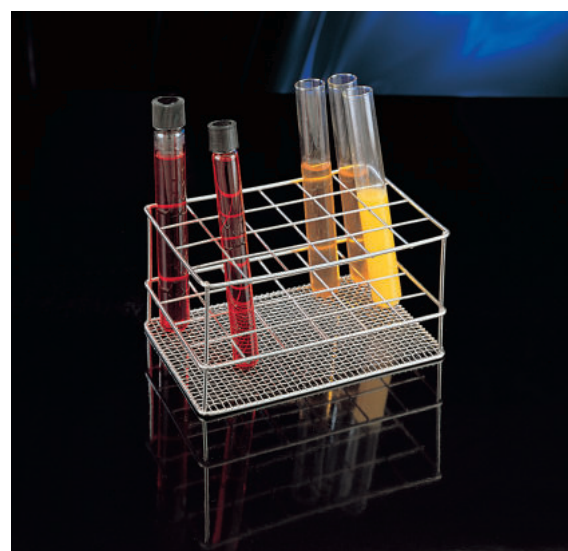

Racks for containers up to 23 mm Ø

Made of stainless steel. 25 mm square holes.

Features a strong woven mesh base.



See other racks for tubes in chapter **Sample Storage**



code	large x width x height mm	tubes capacity	quantity	weight	volume
D-200	265 x 265 x 85	100 (10 x 10)	1	0.50	0.0078
D-230	219 x 166 x 85	48 (8 x 6)	1	0.26	0.0042
D-240	165 x 110 x 85	24 (6 x 4)	1	0.16	0.0020
D-250	111 x 84 x 85	12 (4 x 3)	1	0.10	0.0013

0.4 ml microtubes, Beckman® type

Manufactured in polyethylene.

It can be used at temperatures from **-50 °C** to **75 °C**.

Dimensions: 5.50 x 47.50 mm (Ø x h), capped.

Withstand centrifugation up to **11,000 xg**

See our wide range of racks for microtubes in chapter **Sample Storage**



code	description	case quantity	case weight	case volume
900007	Beckman® type microtube 0.4 ml	1,000	0.63	0.004



0.5 ml microtubes, Vitatron® type

Manufactured in polypropylene.

Autoclavable. Graduated.

Easy handling caps: they can be opened and closed with one hand.

Dimensions: 7.87 x 31.8 mm (diameter x height) capped.

Withstand centrifugation up to **14,000 xg**



code	description	case quantity	case weight	case volume
900118	Vitatron® type microtube 0.5 ml	12 x 1,000	7.00	0.052



0.5 ml microtubes, Vitatron® type

Made of **autoclavable** polypropylene. Ideal for little sample volumes, microtechniques, microsedimentation, etc.

Suitable for transport, storage and freezing of biological samples.

Watertight closing system. Easy handling caps: they can be opened and closed with one hand.

Easily pierceable.

The rim in the inner part of the cap assures an optimum watertightness.

Resist temperatures from **-10 °C** to **130 °C**.

Dimensions: 7,50 x 31,25 mm (Ø x h) capped.

Will withstand centrifugation up to **11,000 xg**.



code	description	case quantity	case weight	case volume
900117	Vitatron® type microtube 0.5 ml	14 x 1,000	7.30	0.069

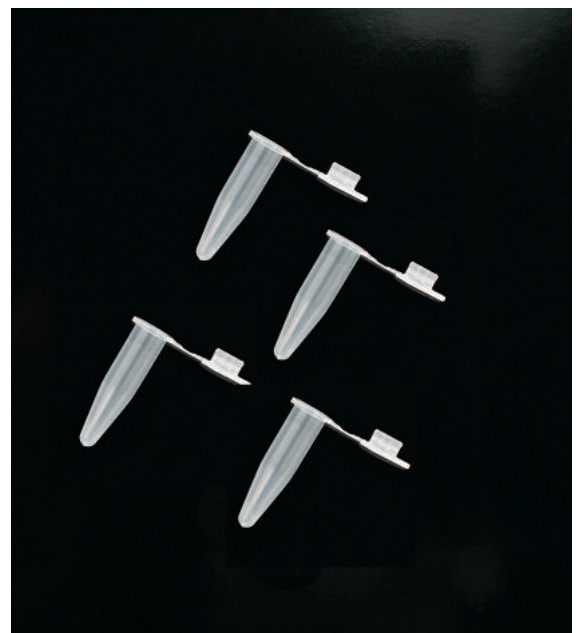



0.5 ml microtubes

Made of ultra clear polypropylene. **Autoclavable**. Tubes have a frosted writing surface on side and on closure for better sample identification.

Caps are easy to handle and can be opened and closed with one hand. Lids are easily pierceable. Tubes have moulded-in graduations in 100 µl increments from 0.1 to 0.6 ml.

Model **4092.1NS**, with a low adhesion surface, is specially designed for research procedures such as protein work and nucleic acid amplifications.

Made from special resins to minimise liquid retention and ensure optimum sample yield, thus eliminating the use of lubricants that may be harmful to samples. The proprietary formulation is completely **non-reactive**.

RNAse, DNase and PCR inhibitors free.

Can be used from **-80 °C to 121 °C**.

Dimensions: 30 x 8 mm.



Will withstand centrifugation up to **17,000 xg**.

code	description	case quantity	case weight	case volume
4092.1N	natural graduated	10 x 1,000	7.28	0.053
4092.1NS	low adherence natural graduated	10 x 500	3.42	0.028



Standard 1.5 ml microtubes

Made of ultra clear polypropylene. **Autoclavable**.

Attached flat caps.

Tubes can be easily opened and closed with one hand. Ideal for the storage and freezing of any kind of biological material (cells, sperm, bacteria, etc.).

Can be used at temperatures down to **-100 °C**.



Will withstand centrifugation up to **21,000 xg**.

code	dimensions Ø x h mm	colour	case quantity	case weight	case volume
200400	10.86 x 39.06	natural	5 x 1,000	5.40	0.051
200401	10.86 x 39.06	yellow	5 x 1,000	5.40	0.051
200405	10.86 x 39.06	blue	5 x 1,000	5.40	0.051
200407	10.86 x 39.06	green	5 x 1,000	5.40	0.051
200410	10.86 x 39.06	orange	5 x 1,000	5.40	0.051



1.5 ml microtubes

Manufactured in polypropylene. **Autoclavable**.

Easy opening and closing.

Graduated tube.

It features a frosted area for writing. Flat cap.



Will withstand centrifugation up to **21,000 xg**.

code	dimensions Ø x h mm	case quantity	case weight	case volume
200400P	10.2 x 39.9	12 x 500	7.4	0.055

1.5 ml safety lock microtubes

Made of ultra clear polypropylene. Feature a special "snap-seal" secure lock. A special locking clasp with a distinctive audible snapseal design ensures tubes will not open during centrifugation. Tubes have a frosted writing surface on side and on attached closure for better sample identification. Caps are easy to handle and can be opened and closed with one hand. Lids are easily pierceable. Tubes have moulded-in graduations in 0.5 ml increments. **Autoclavable.**

Withstand centrifugation up to **15,000 xg**.



code	dimensions Ø x h mm	case quantity	case weight	case volume
4092.4N	11 x 39	10 x 500	7.00	0.046



Premium 1.5 microtube. Safety lock

Same features as code 4092.4N besides is **free of DNA, DNase, RNase and pyrogens**. **Autoclavable.** Can be used from **-90 °C** to **121 °C**.



Withstand centrifugation up to **20,000 xg**.



code	dimensions Ø x h mm	case quantity	case weight	case volume
4092.5N	11 x 39	10 x 500	5.76	0.055



1.5 microtubes with secure lock pick-up tab

Same characteristics as code 4092.5N but these microtubes include a pick-up tab for easier handling without actually touching the tube. **Pierceable cap.** **Autoclavable.** Withstand temperatures from **-175 °C** to **121 °C**.

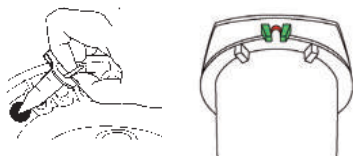

Withstand centrifugation up to **17,000 xg**.



code	colour	case quantity	case weight	case volume
4091.1N	naturel	10 x 500	4.94	0.045

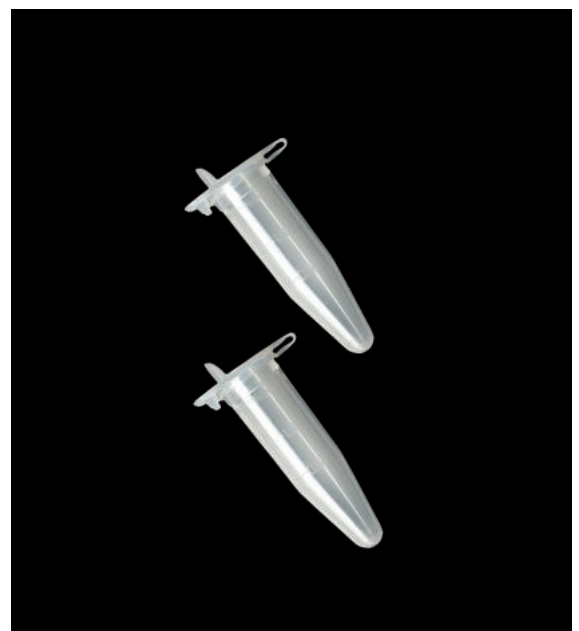



1.5 ml graduated microtubes

Made of ultra clear polypropylene.

Autoclavable.

Feature a frosted writing surface on side and on closure for better sample identification. Caps are easy to handle and can be opened and closed with one hand. Lids are easily pierceable.

Can be used from **-170 °C to 121 °C**.

Dimensions: 39 x 11 mm.

Caps specially designed to reduce popping when centrifugation, freezing, boiling, storing or shipping is required.

- when the objective is to avoid liquid remaining on the wall of the tube, just push the cap slightly and a little centrifugation time is required.
- when centrifugation is required, push the cap firmly to achieve complete closure.



Withstand centrifugation up to **20,000 xg**.

code	colour	case quantity	case weight	case volume
4092.2N	natural	10 x 500	6.82	0.048

Other colours under request.



1.5 ml microtubes. DNASE, RNASE free

Made of ultra clear polypropylene. **Autoclavable.**

Attached flat caps.

Graduated from 100 µl.

Tubes can be easily opened and closed with one hand. Ideal for the storage and freezing of any kind of biological material (cells, sperm, bacteria, etc.).

Can be used at temperatures from **-90 °C to 121 °C**.

DNase, RNase, DNA and PCR inhibitors free.

Dimensions (∅ x h): 10.7 x 39.1 mm.



Withstand centrifugation up to **20,000 xg**.

code	colour	case quantity	case weight	case volume
4092.3N	natural colour	10 x 500	6.77	0.054
4092.3NS	natural colour, clear siliconised	10 x 250	3.70	0.026



2 ml microtubes with attached caps

Made of ultra clear polypropylene. **Autoclavable.**

Certified RNase and DNase free.

Feature a frosted writing surface on side and on closure for better sample identification. Easy handling: tubes can be opened and closed with one hand. Lids are easily pierceable.

Tubes have moulded-in graduations in 100 µl increments up to 2 ml.

Dimensions: 9 x 40 mm.

Can be used at temperatures from **-90 °C up to 121 °C**.

Model **4092.6NS** has a low adhesion surface for special applications such as protein work.



Withstand centrifugation up to **17,000 xg**.

code	colour	case quantity	case weight	case volume
4092.6N	natural colour	10 x 500	7.27	0.053
4092.6NS	natural colour, clear siliconised	10 x 250	4.09	0.036

Minimum order quantity: 500 and 250 units respectively.

2 ml graduated microtube

Microtubes made of ultra clear polypropylene. **Autoclavable.**
 2 ml graduated tubes with frosted area for writing.
 Flat cap that features a secure lock with safety shield.
 Easy handling with just one hand.
 They can be used at temperatures from **-86 °C** up to **121 °C**.

Withstand centrifugation up to **10,000 xg**.

code	dimensions Ø x h mm	case quantity	case weight	case volume
4092.7N	10.3 x 40.5	10 x 500	5.89	0.056

5 ml Graduated Microtube

5 ml microtubules are the perfect choice for intermediate volume between microcentrifuge tubes and 15 ml conical tubes.
 Made of transparent polypropylene. The microtubes are graduated each 250 µL and are supplied with a matte band able to write in.
 Flat cap is attached to the tube. Easy handling; microtube can be opened and close with one hand.
 Can be used from Resistant to temperatures from **-80 °C** to **121 °C**.
Autoclavable. Free of DNA, DNase, RNase and PCR inhibitors.

Whitstand centrifugation up to **25,000 xg**.

code	dimensions Ø x h mm	case quantity	case weight	case volume
4092.8N	1.9 x 6	250	0.813	0.0078

Please find racks for these microtubes on chapter **Sample Storage**



See **M-015** pag. 220



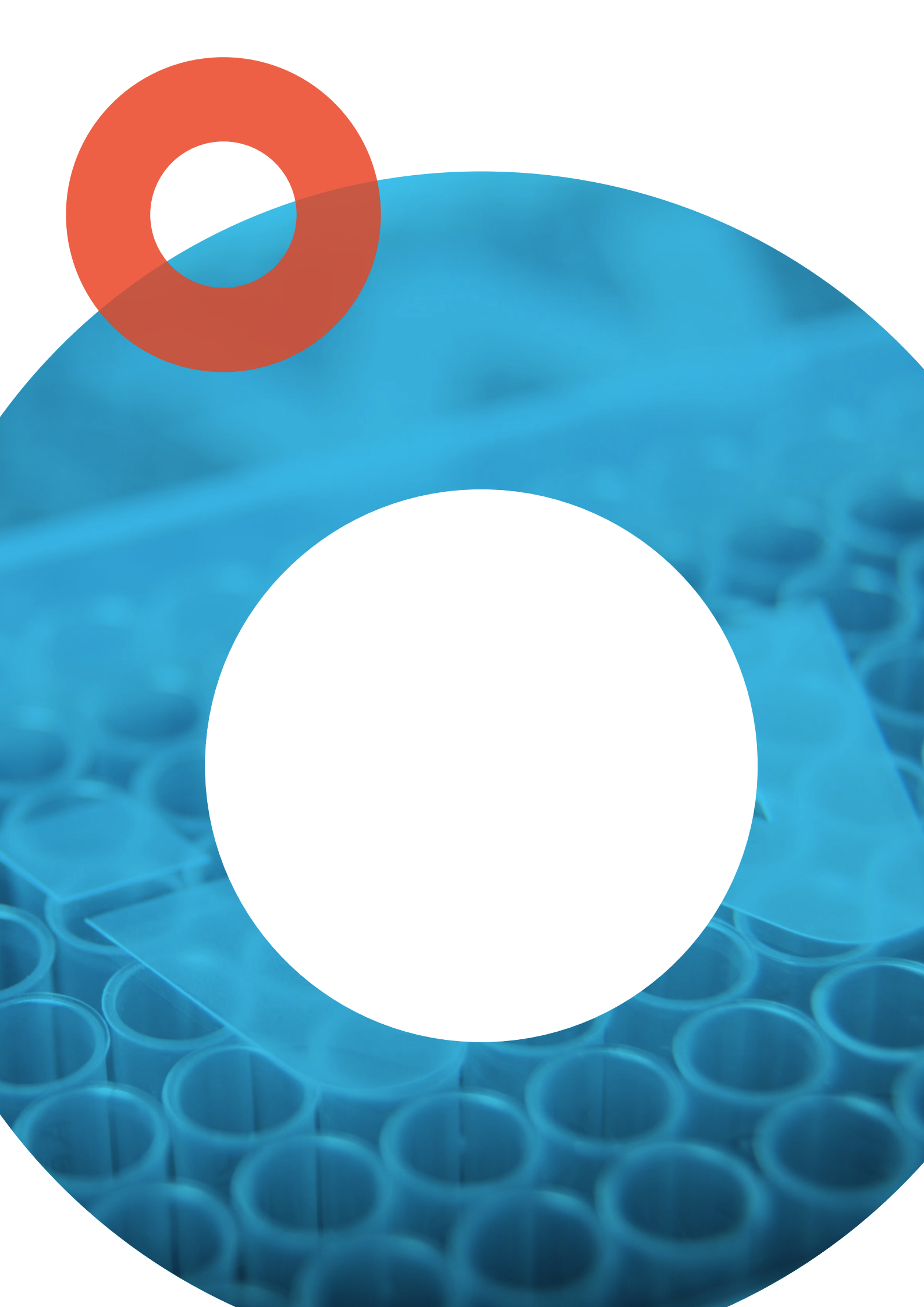

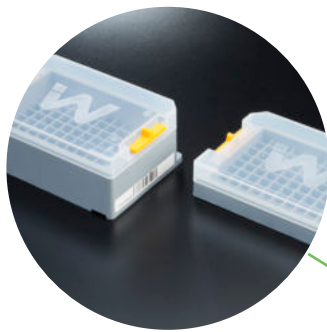

COLD STORAGE

 deltalab



Screw thread microtubes

Made of **autoclavable** polypropylene, they can be used at extreme temperatures from **-190 °C to +121 °C**. Two versions available: in transparent polypropylene, or opaque brown (**UV resistant**, designed to be used with light sensitive samples). **Certified RNase, DNase and pyrogen free**. Caps are supplied separately, see below. Dimensions: 11 x 44 mm.



Tubes and caps Can be centrifuged at **17.000 xg**.

mod.	code	volume ml	skirt	case quantity	case weight	case volume
Transparent polypropylene						
1	409110.1	0.5	yes	1,000	1.47	0.010
2	409110.2	1.5	yes	1,000	1.45	0.009
3	409110.3	1.5	no	1,000	1.42	0.009
4	409110.4	2.0	yes	1,000	1.30	0.010
Brown polypropylene						
5	409113.1	0.5	yes	1,000	1.54	0.009
6	409113.2	1.5	yes	1,000	1.34	0.009
7	409113.3	1.5	no	1,000	1.43	0.009
8	409113.4	2	yes	1,000	1.34	0.009

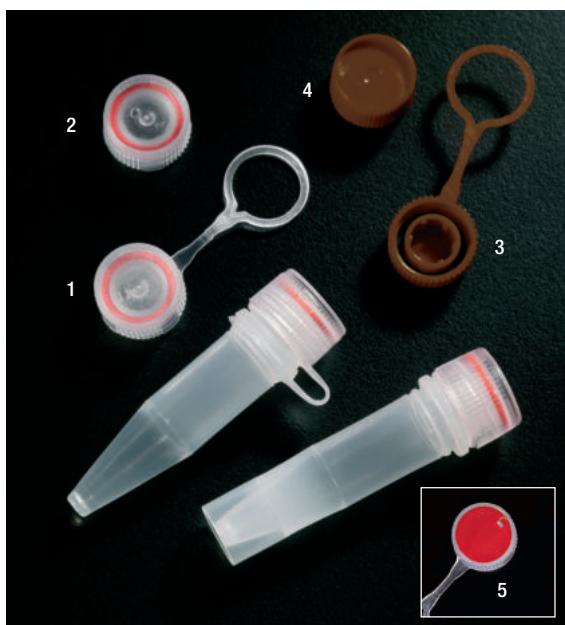

Caps for screw thread microtubes

Made of polypropylene. Caps are available either with an attachment loop or without loop. Both models have a sealing O-ring (red) of silicone to ensure a positive leakproof seal. For sample identification, colour coding inserts can be placed upon caps (made of polypropylene). Cap dimensions: 13 x 8 mm.



mod.	code	description	case quantity	case weight	case volume
Transparent polypropylene					
1	409007.N	cap with loop	1,000	0.41	0.003
2	409008.N	cap without loop	1,000	0.40	0.002
Brown polypropylene					
3	409007.M	brown cap with loop	1,000	0.45	0.003
4	409008.M	brown cap without loop	1,000	0.55	0.010
Inserts					
5	409111R	red insert	500	0.06	0.001



Screw cap microtubes, with cap. Sterile

Tubes and caps in medical grade, transparent polypropylene. The cap embodies a non-reactive ethylene-propylene o-ring. Suitable for **autoclave, liquid nitrogen (gaz) and boiling processes**. Perfect for long term storage.

Withstand temperatures from **-190 °C**.

DNase, RNase, DNA, and PCR inhibitors free.

Graduated models feature a frosted area for writing.

The non-graduated model incorporates an external grip for an easy handling. Microtubes are supplied capped, in bags of 50 units.



Withstand centrifugation at **20.000 xg**.

code	description	sterility	graduation	case quantity	case weight	case volume
409115/4	0.5 ml skirted	STERILE R	no	50 x 50	5.90	0.030
409115/2	1.5 ml non skirted	STERILE R	yes	50 x 50	5.90	0.030
409115/6	2 ml skirted	STERILE R	yes	50 x 50	5.90	0.030
409115/3	2 ml non skirted	STERILE R	yes	50 x 50	5.90	0.030

Screw thread microtubes

Made of transparent polypropylene. Suitable for use in liquid nitrogen, autoclave and for boiling applications, and can be used at temperatures down to $-190\text{ }^{\circ}\text{C}$. **Certified RNase, DNase and PCR inhibitors free.**

Products ideal for long term sample storage. The codes **409111/4**, **409111/5** and **409111/6**, with external moulded slots for better handling with gloves. Dimensions: 10.3 x 44.5 mm (except code **409111/2**: 10.3 x 43.6 mm). Caps are supplied separately, see below.

Withstand centrifugation at **20.000 xg**.



mod.	code	description	graduation	case quantity	case weight	case volume
1	409111/4	0.5 ml skirted	no	500	0.78	0.005
2	409111/2	1.5 ml	yes	500	0.61	0.005
3	409111/5	1.5 ml skirted	no	500	0.73	0.005
4	409111/3	2.0 ml	yes	500	0.71	0.005
5	409111/6	2.0 ml skirted	no	500	0.76	0.005
6	409111/7	2.0 ml skirted	yes	500	0.73	0.005



Caps for screw thread microtubes

Made of medical grade polypropylene. Feature an internal O-ring to ensure leakproof seal. Dimensions 13.0 x 6.0 mm.

Certified RNase, DNase and PCR inhibitors free.

code	colour	case quantity	case weight	case volume
409112/0	natural	500	0,21	0,0009
409112/1	blue	500	0,21	0,0009
409112/2	green	500	0,21	0,0009
409112/4	red	500	0,21	0,0009
409112/6	yellow	500	0,21	0,0009



Screw thread tamper evident microtubes

Microtubes and caps are made of autoclavable ultra clear polypropylene. Ribbed cap with internal silicone O-ring for a positive **leakproof seal**. Super fast $\frac{1}{4}$ turn thread design. **Tamper evident** seal which notices if microtube has been opened. **Rnase, Dnase and Pyrogen free.** They can be used at extreme temperatures from $-196\text{ }^{\circ}\text{C}$ to $121\text{ }^{\circ}\text{C}$. Resistance to centrifugation: **17,000 xg**. Microtube dimensions: 11 x 44 mm. Cap dimensions (with tamper-evident ring): 15 x 9 mm. Used on:

- Test of fertility and DNA testing
- Packaging of diagnostic kits and reagents
- Forensic laboratories

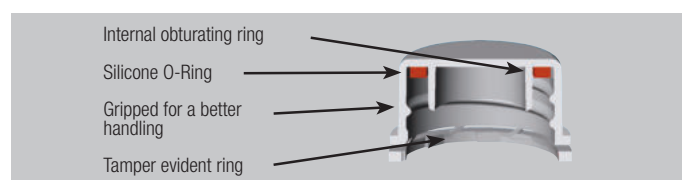

Withstand centrifugation at **17.000 xg**.



mod.	code	volume ml	case quantity	case weight	case volume
1	409110.4T	2	1,000	2.06	0.013
2	409110.2T	1.5	1,000	2.06	0.013

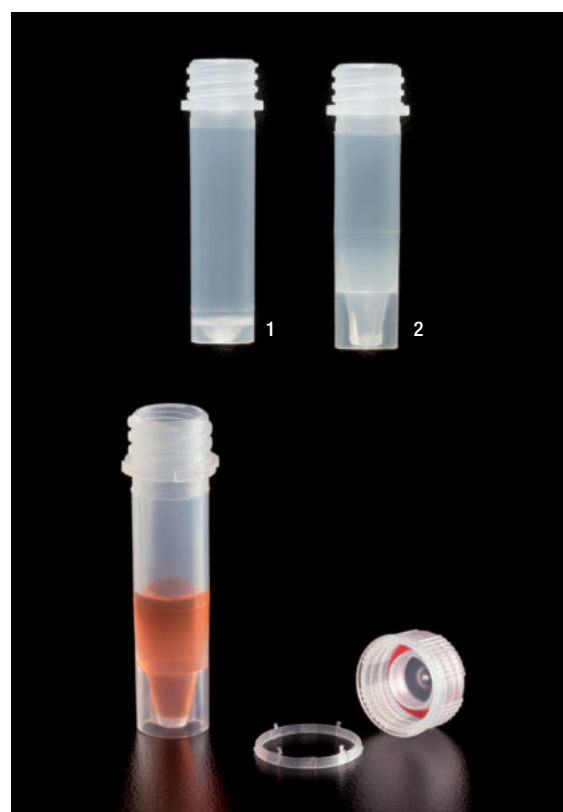

STERILE CRYOVIALS

Tubes made of **autoclavable** polypropylene. Designed for the storage of biological material at temperatures as low as **-196 °C**. (Liquid Nitrogen but in gas state). Cryovials have printed graduations and feature a white marking area for sample identification. Caps and tubes have both the same coefficient of expansion, which further enhances their leakproof qualities at changing temperatures. Caps are manufactured in polyethylene¹ and embody a silicone O-ring that guarantees leakproof. Colour code inserts can be fitted into the caps for identification.

All cryovials are certified RNase, DNase and pyrogen free. Cryovials are **sterilized by radiation** and are packaged in safety-lock bags of 100. Supplied capped.

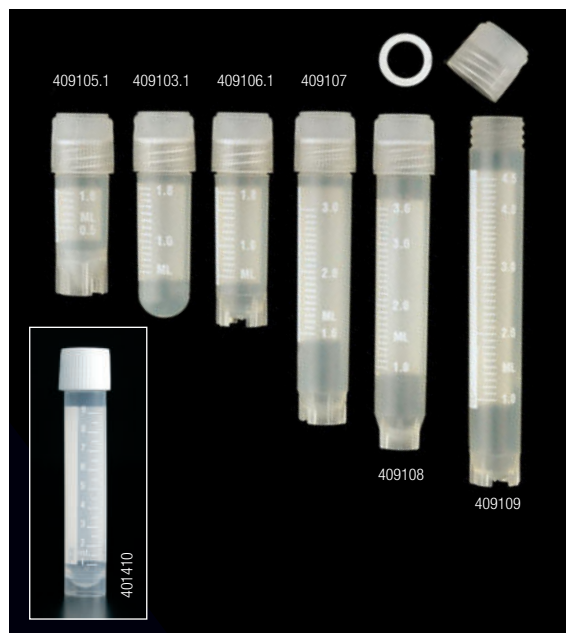

Cryovials with external threads

Minimize liquid retention. Non skirted versions withstand centrifugation up to **17,000 xg**.

¹ 10 ml cryovial (code **401410**) features a polyethylene cap which does not accept inserts.



code	volume ml	skirt	dimensions mm*	case quantity	case weight	case volume
409105.1	1.2	yes	12.5 x 42	10 x 100	2.50	0.014
409103.1	2.0	no	12.5 x 47	10 x 100	2.70	0.017
409106.1	2.0	yes	12.5 x 49	10 x 100	2.68	0.015
409107	3.0	yes	12.5 x 71	10 x 100	3.88	0.023
409108	4.0	yes	12.5 x 77	10 x 100	3.90	0.028
409109	5.0	yes	12.5 x 92	10 x 100	4.60	0.023
401410	10.0	yes	17.0 x 84	10 x 50	2.80	0.020

* Capped.



Cryovials with internal threads

Non skirted versions withstand centrifugation up to **14,000 xg**.



See racks at page 216



code	volume ml	skirt	dimensions mm*	case quantity	case weight	case volume
409001	1.2	yes	12.5 x 41	10 x 100	1.94	0.015
409002	2.0	no	12.5 x 48	10 x 100	2.22	0.016
409002.1	2.0	yes	12.5 x 49	10 x 100	2.24	0.015
409003	4.0	no	12.5 x 70	10 x 100	3.79	0.028
409003.1	4.0	yes	12.5 x 72	10 x 100	3.90	0.028
409003.2	5.0	no	12.5 x 90	10 x 100	4.60	0.024

* Capped.



Colour coded inserts

Made of polypropylene. Very convenient for colour identification in freezers, on benchtops etc.

Fit precisely into the caps of cryovials. They feature a little hole in order to help removing them from the cap. Not suitable for code **401410**.

code	colour	case quantity	case weight	case volume
409003A	blue	500	0.08	0.0005
409003AM	yellow	500	0.08	0.0005
409003R	red	500	0.08	0.0005
409003V	green	500	0.08	0.0005

NON STERILE CRYOVIALS WITH EXTERNAL THREADS

Made of polypropylene. Designed for the storage and transportation of biological material. The external thread design provides a smooth and uniform inner surface, thus reducing the risk of contamination. Tubes can be **autoclaved to 121 °C** and withstand temperatures down to **-190 °C**. The closures and tubes are both manufactured of polypropylene having the same coefficient of expansion, which further enhances their leakproof qualities at changing temperatures. Cryovials withstand centrifugation up to **17,000 xg**. Skirted tubes are not recommended for centrifugation. Available with or without graduation and white band. Caps suitable for these cryovials are supplied separately, see code **409110** and series.

Cryovials printed without graduation



code	volume ml	skirt	dimensions mm*	case quantity	case weight	case volume
409102.1	1.2	yes	12.5 x 43	1,000	1.38	0.007
409104.1	2.0	no	12.5 x 48	1,000	1.49	0.007
409106.2	2.0	yes	12.5 x 49	1,000	1.72	0.007
409107.1	3.0	yes	12.5 x 72	1,000	2.48	0.020
409108.1	4.0	yes	12.5 x 76	1,000	2.89	0.018
409109.1	5.0	yes	12.5 x 93	1,000	3.67	0.026

* Capped

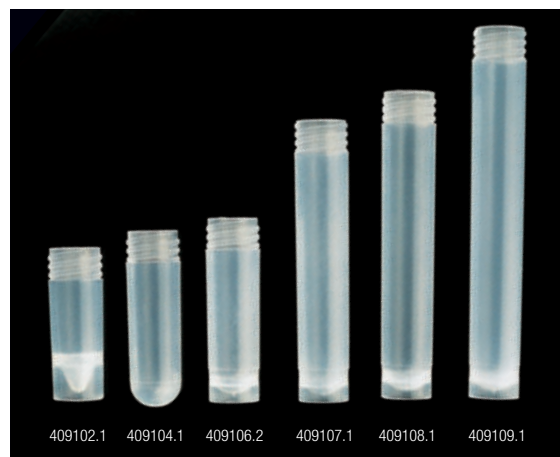

Cryovials with graduation and band



code	volume ml	skirt	dimensions mm*	case quantity	case weight	case volume
409132	2.0	yes	12.5 x 49	1,000	1.69	0.009
409133	3.0	yes	12.5 x 72	1,000	3.77	0.010
409135	4.0	yes	12.5 x 76	1,000	2.92	0.018

* Capped

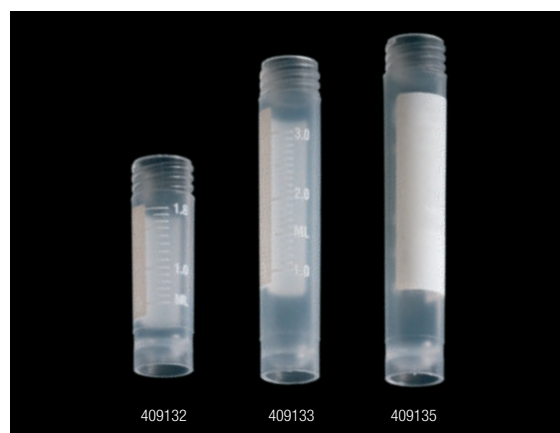

Caps for the above tubes

Made of polypropylene. Feature a long skirt and a special thread design allowing them to be removed or sealed with a single turn and assuring a better protection of the content. A silicone washer ensures a positive leakproof seal at all temperatures. Caps are made of polypropylene having the same coefficient of expansion as the above cryovials. See the previous page for colour inserts to fit into these caps.

code	colour	case quantity	case weight	case volume
409110	natural	1,000	0.80	0.004
409110/1	blue	1,000	0.79	0.004
409110/4	red	1,000	0.79	0.004



Canes for cryovials

Made of aluminium. Suitable for the storage of five or six 1.2 or 2.0 ml tubes in liquid nitrogen freezers such as Dewar flasks.

code	dimensions mm	case quantity	case weight	case volume
409120	290	12	0,11	0,001



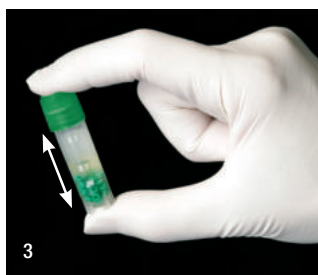

CRYOINSTANT: Cryoplashes for the conservation of microbiological strains

Sterile system for the conservation of microbiological strains (for example, fungi in sporulation phase), consisting of a 2 ml cryovial with a skirt, containing 25 glass cryoprobes treated with cryoprotectants that act as a preservative.

Thanks to this system we can:

- Have a **perfect means of conservation**
- Obtain up to **25 replicas** of the same microbial generation to use progressively for years
- Facilitate the inoculation of the bacteriological medium, since each pearl is equivalent to a culture
- Dispense with the defrosting of the entire vial every time we extract a pearl
- Avoid the formation of ice crystals in recovery
- **Minimize the risk of cross contamination**
- **Save freezer space**

COMPONENTS

The cryovial made of polypropylene is external thread. Resists up to **-190 °C**. Long skirt cap, with silicone gasket To facilitate the classification of samples, our cryovials are offered with caps and pearls in five different colors (except code 409113/6, which is an assortment).

This system allows rapid identification of the sample, differentiating each type of microorganism according to the color of the cap and the pearl. The cryovials are presented in a rack of 100 units, made of cardboard resistant to **-100 °C**. Each box is supplied labeled with indication of code, batch, expiration, cap color, and shrink wrap.

Rack dimensions: 150 x 150 x 55mm. (More information about these boxes on page 214. See code M-600).

Expiration: 48 months from the date of manufacture. **Sterile by autoclave.**

HOW TO USE

1. Take the strain sample using a handle (see our handles on page 34 and 35)
2. Inoculate the vial by inserting the handle into the preservative medium
3. Close the vial and shake it gently so that the strain is impregnated in the cryoplashes
4. Extract the remaining preservative medium using a Pasteur pipette (see our Pasteur pipettes between pages 198-203)
5. Close the cryovial and freeze
6. Every time we want to reproduce the strain, we will extract one of the cryoplashes with a handle or a clamp
7. We will place the cryoperle on a plate with medium, ensuring that the entire surface of the pearl enters in contact with the medium

code	beads and cap colour	case quantity	case weight	case volume
409113/1	○	100	0.59	0.002
409113/2	●	100	0.59	0.002
409113/3	●	100	0.59	0.002
409113/4	●	100	0.59	0.002
409113/5	●	100	0.59	0.002
409113/6	assorted: 5 colours x 20 cryovials	100	0.59	0.002



SOLUTIONS FOR CRYOPRESERVATION

Wilmut offers a **wide range of biological simple storage tubes** that fit in the 96-well plate SBS standard format, and single tubes which are compatible with any freezing box format.

With volumes in between 0.5 ml and 1 ml and different options of codification that allows Wilmut system **adapt to the needs of any laboratory or biobank**. They are products designed and oriented exclusively to the user.

Main features

- It is the tube with more capacity in the minimum space: maximum space optimization of the freezers (from 15 % to 75 % of space saving)
- Maximum traceability: 2D datamatrix code, legible code at the tube, and bar code in the rack
- Traceability files available at www.wilmut.es or using software management

WILMUT tubes:

Made with high quality polypropylene, with volume indicator in the tube, **autoclavables at 121 °C** and allows storage up to **-86 °C**.

WILMUT Cryoboxes:

Polypropylene Cryoboxes with standard SBS 96-well format with security closers easy to open even when are frozen.

Accessoires WILMUT:

Wilmut a une grande gamme d'accessoires pour compléter la gamme de tubes codifiés et non codifiés: caps, lockers, pischers, cappers, decappers, labels, scanners, etc.

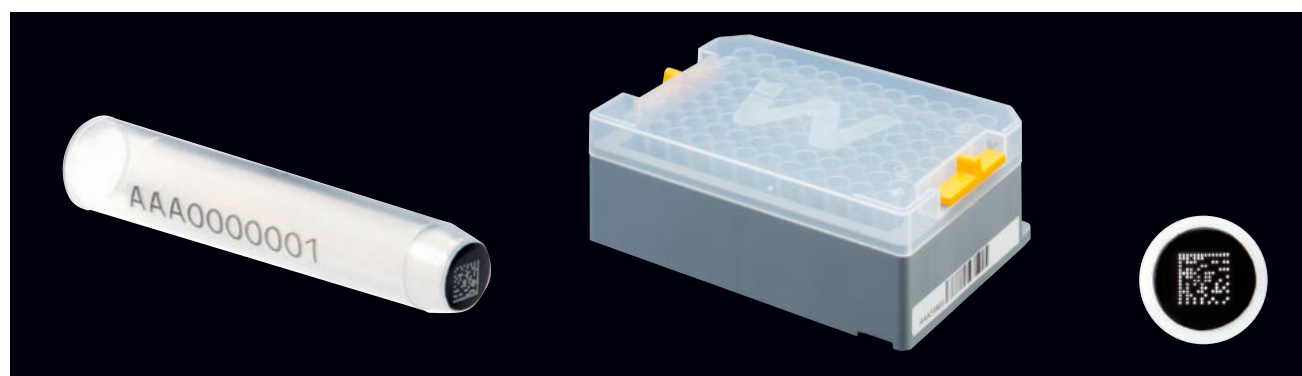

NON CODED TUBES

Wilmut Seroteca (W-SER)

For users who need to process and store biological samples. Low adherence PP, low cytotoxicity and extractable levels, and **DNase, RNase, human DNA and endotoxines free**.



code	gross volume ml	net volume ml	presen- tation	min. order quantity	case quantity	case weight	case volume
W051100	0.65	0.5	bag	960 u	40 x 960	12.90	0.096
W121100	1.4	1	bag	960 u	20 x 960	7.14	0.096

* 20 racks to 96 tubes and 12 racks to 96 tubes.

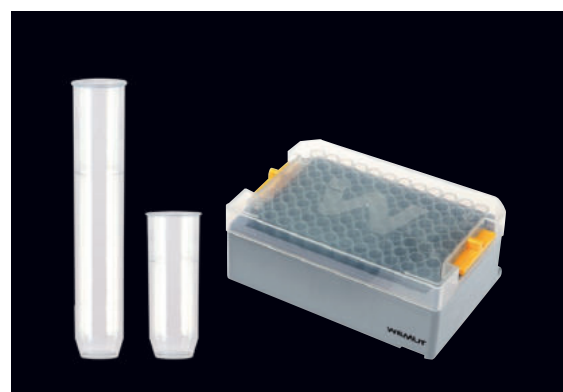

Wilmut Eco (W-ECO)

Low adhesion PP, low levels of cytotoxicity and extractables.



code	gross volume ml	net volume ml	presen- tation	min. order quantity	case quantity	case weight	case volume
W058100	0.65	0.5	bag	960 u	40 x 960	12.50	0.096
W128100	1.4	1	bag	960 u	40 x 960	11.90	0.096
W128960	1.4	1	rack	10 x 96*	10 x 96	1.62	0.006

* 10 racks to 96 tubes.

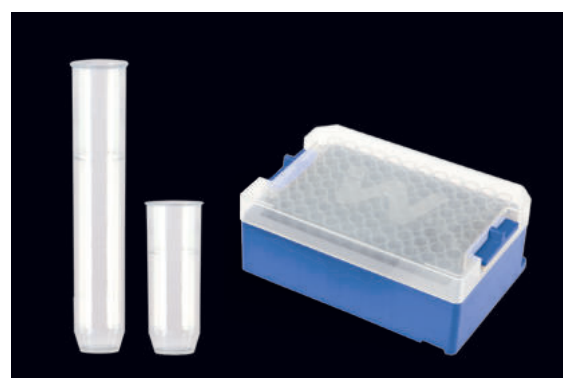

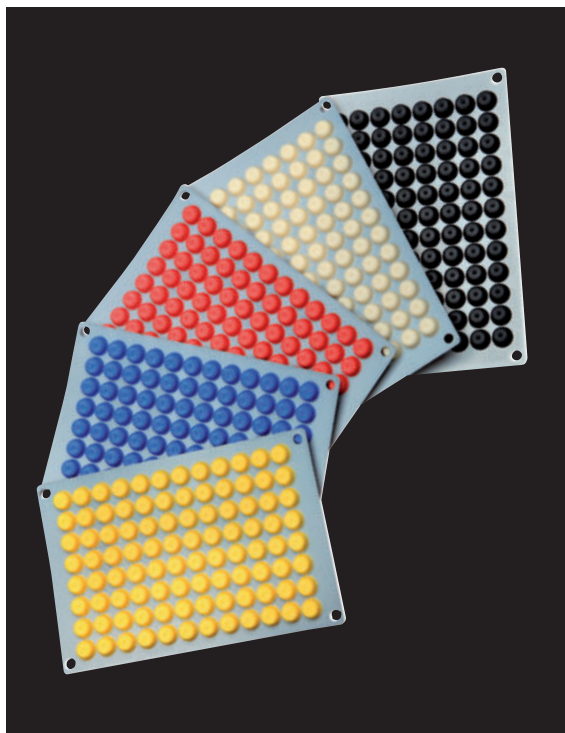

Plug Style caps W-SEAL

Made with high quality TPE that assures a perfect adjustment with the tube and an hermetic sealing at temp. to **-86 °C**.

Available in different colors for visual sample identification.

DNase, RNase, human DNA and endotoxins free.



code	presentation	colour	case quantity	case weight	case volume
W999600	sheet 10x96	light grey	10 x 96	6.08	0.026
W999601	sheet 10x96	blue	10 x 96	6.08	0.026
W999602	sheet 10x96	black	10 x 96	6.08	0.026
W999603	sheet 10x96	red	10 x 96	6.08	0.026
W999604	sheet 10x96	yellow	10 x 96	6.08	0.026
W990000	bag 960 u	light grey	960	9.21	0.026
W990001	bag 960 u	blue	960	9.21	0.026
W990002	bag 960 u	black	960	9.21	0.026
W990003	bag 960 u	red	960	9.21	0.026
W990004	bag 960 u	yellow	960	9.21	0.026

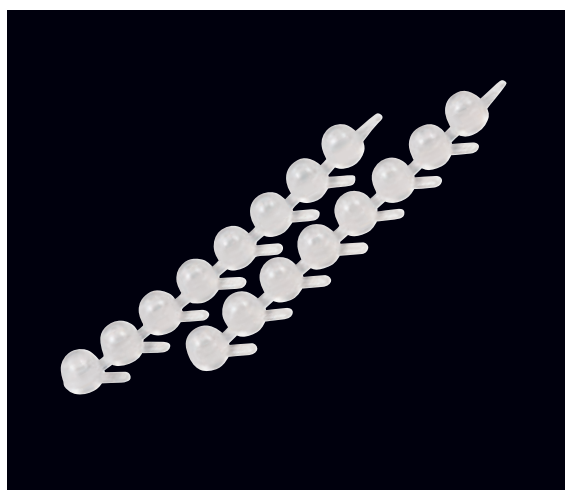

PET 8 strip caps polyethylene

High quality polyethylene 8 strip caps.

code	presentation	case quantity	case weight	case volume
409005	bag 120 u	5 x 120	0.80	0.008

PP WILMUT CRYOBXES

W-RACK 96 Cryoboxes (empty)

Made with high quality PP, resistant up to **-86 °C** and autoclavable at **121 °C**.



code	description	case quantity	case weight	case volume
W000050	cryobox for 0.65 ml tube	18	1,14	0,0069
W000120	cryobox for 1.4 ml tube	10	1,14	0,0069
W000059CL	coded cryobox for 0.65 ml tube	18	1,14	0,0069
W000129CL	coded cryobox for 1.4 ml tube	10	1,16	0,0069

The cryoboxes are supplied with cryolabel compatible with liquid handling robots.

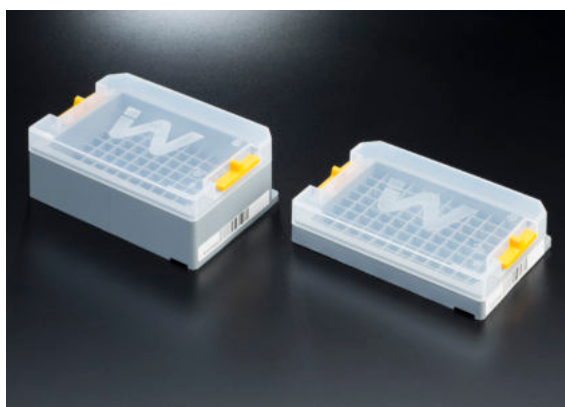

CODIFIED WILMUT TUBES

W-2D I TUBES WITH 2D DATAMATRIX CODIFICATION

Designed for laboratories and biobanks that need maximum security and requirements on the traceability and management of their samples.

W-2D tubes simplify the identification and traceability of the samples during the processing, storage and sending, while offering the highest standards of quality. We present a range of 0.65 ml and 1.40 ml volume tubes, with the possibility of choosing the type of codification that suits the laboratory requirements the best.

- **Laser engraved codes.** The codes are laser engraved directly on each tube so that the codes are permanent, non-transferable and unique.
- **2D Datamatrix codification on the tube.** For an automatic management of traceability using any scanner.
- **Human readable alphanumeric codification on the side of the tube.** For a visual confirmation of the traceability without the need of a scanner.
- **Solid one-piece construction.** Avoids the use of tags or liners that can rip or come off at low temperatures or because of an accidental fail.
- **DNase, RNase, human DNA and Endotoxines free.** Certified by an accredited external laboratory.
- **Low adherence in the interior of the tube.** Manufactured with low binding polypropylene to allow the lowest retention in the tube.
- **Volume visual indicator of the tube.** From 0.5ml to 1ml. Allows a visual identification of mistakes in the dispensation of volume.



W-2DRP I Tubes with 2D Datamatrix codification

code	description	gross volume (ml)	net volume (ml)	sales unit	weight	volume
Bag tubes						
W053100	Tube W-2DST 0,65 ml	0,65	0,50	960 u.	12,90	0,096
W123100	Tube W-2DST 1,40 ml	1,40	1,00	960 u.	11,90	0,096
Rack tubes with cryo label						
W053960CL	Tube W-2DST 0,65 ml	0,65	0,50	20 racks of 96	12,00	0,055
W123960CL	Tube W-2DST 1,40 ml	1,40	1,00	12 racks of 96	12,78	0,060

W-2DRP I Tubes with codification and Right Position System

W-2DRP tubes have an exclusive codification system that visually links the tube code with the rack code and moreover every tube has a defined position on the rack.

MANAGEMENT OF TRACEABILITY

- Downloading of data files through the website. Avoids the scanning of the rack to register it in the management software downloading a file through the data file of the rack, which includes the codes and position of the tubes in the rack.
- Files are compatible and can be integrated with the management software and the aliquot equipment.
- Editable files in excel or TRX format to print or save.
- File management by reading the code of the tube or rack. There are 2 options: manual introduction of the code or by the reading of the rack barcode.

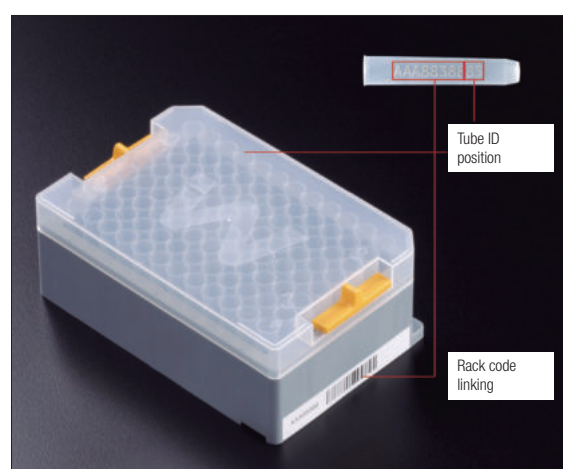

code	description	gross volume (ml)	net volume (ml)	sales unit	weight	volume
W052960CL	Tube W-2DRP 0,65 ml	0,65	0,50	20 racks of 96	12,00	0,055
W122960CL	Tube W-2DRP 1,40 ml	1,40	1,00	12 racks of 96	12,78	0,060



WILMUT ACCESSORIES

Pickers W-PICKER

Tools designed for easily pick tubes from W-rack, one at a time.
Compatible with the whole range of Wilmut tubes, capped or non capped.

code	tubes capacity	presentation	case quantity	case weight	case volume
W000040	1	1	1	0.02	0.0001

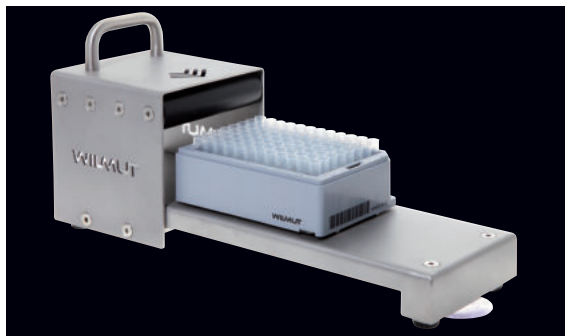

Hand operated capper W-CAPP10

Enables to capp up to 96 tubes at a time in SBS format.
Compatible with the whole range of Wilmut tubes, 1,4 ml and 0,65 ml with an adapter.
Made of top quality materials.

code	description	case quantity	case weight	case volume
W000010	capper W-CAPP10	1	3.30	0.014

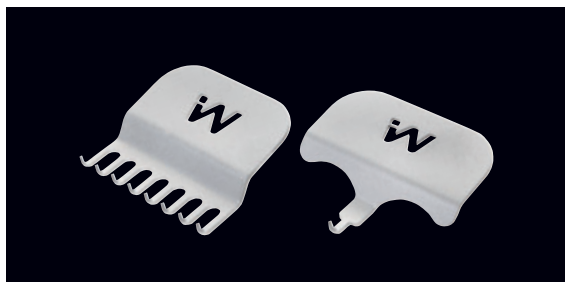

Decappers W-DECAP

Made of aluminum alloy.
Autoclavables and resistant to UV decontamination. Enable to easily remove caps from the tubes, one at a time or in rows of 8 caps.

code	description	case quantity	case weight	case volume
W000011	decapper for 1 tube	5	0.15	0.0001
W000018	decapper for a row of 8 tubes	5	0.20	0.0002



2D Bed Scanner W-DATAPAQ 96

Allows to scann 96 tubes rack in just 10 seconds.
Integrates fully into robotic platforms.
Surface treated specially for avoiding errors while reading freezed tubes.
Rack scanner with cryoprotection: Prevents the scanner window from misting up when a cold rack from a freezer is scanned.
This passive technology does not use heat ot blown air.

code	description	case quantity	case weight	case volume
W009680	bed scanner for 96 tubes	1	3.27	0.033



2D and 1D manual code reader W-READER

Scan of tubes, boxes, or cryoracks one by one.
They are supplied with a support that allows their use in an automatic way.
Allows the reading of codes on shiny surfaces.

code	description	case quantity	case weight	case volume
W001400	USB code reader	1	0.76	0.003

METALIC CRYORACKS FOR SAMPLE STORAGE

Made with high quality materials compatible and adaptable to any storage format: boxes, racks, tubes, moulds, etc., and all types of cryostorage equipment: refrigerators, freezers, deep freezers, nitrogen tanks, walk in cool rooms, etc. We produce all sort of metallic racks: vertical, horizontal, cell system racks, tray racks, etc., including also customized solutions to adapt to the customer needs.

Horizontal metal racks

Horizontal racks in hi-performance stainless steel type AISI 304. With FB system of no-slip trays for easy storage and search of samples. Maximum size of the boxes to storage: 55mm height and 136 mm width

code	number of trays	measures (Z x Y x X) mm	type A boxes capacity (90x130)	type B boxes capacity (135x135)	type C boxes capacity (135x270)	weight	volume
FB534S	4	234 x 427 x 140	16	12	4	3.50	0.050
FB544S	4	234 x 565 x 140	24	16	8	3.90	0.050
FB545S	5	290 x 565 x 140	30	20	10	4.80	0.050

Handmade production enables Deltalab to manufacture racks customised to your own specifications. For more information contact our sales dept.

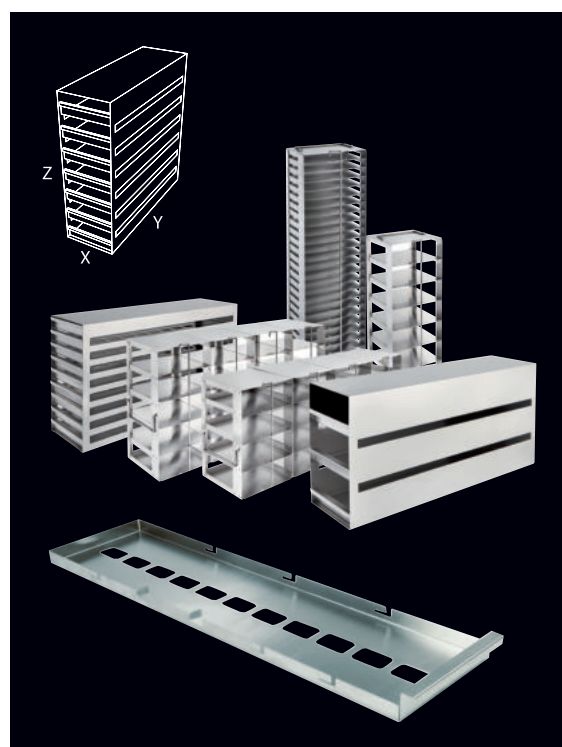

CRYOGENIC STORAGE BOXES

W-Coat

Vegetal fiber storage boxes for biological samples to temp down to **-196 °C** (phase vapour). Made with a spetial moisture repelent coating to ensure greater durability. They are supplied assembled and include divider. Size: 133 x 133 mm.

code	colour	height mm	dividers	cells Ø mm	case quantity	case weight	case volume
With divisors							
W350900	white	50	9x9	13	36	3.50	0.034
W370900	white	75	9x9	13	36	3.50	0.034
W310900	white	100	9x9	13	36	3.50	0.034
Without divisors							
W350990	white	50	no	-	36	2.80	0.034
W370990	white	75	no	-	36	2.80	0.034
W310990	white	100	no	-	36	2.80	0.034

*Disponibles en d'autres couleurs de boîtes et d'autres numéros de cellules pour différents diamètres de tubes. Consulter avec le département commercial.



Dividers to W-Coat and W-Coat AIY

Size: 133 x 133 mm. White colour.

code	dividers	cells Ø mm	height mm	case quantity	case weight	case volume
W031230	12 X 12	10	30	36	1.80	0.0070
W030940	9 X 9	13	40	36	0.81	0.0050

For other measures, contact our commercial department.

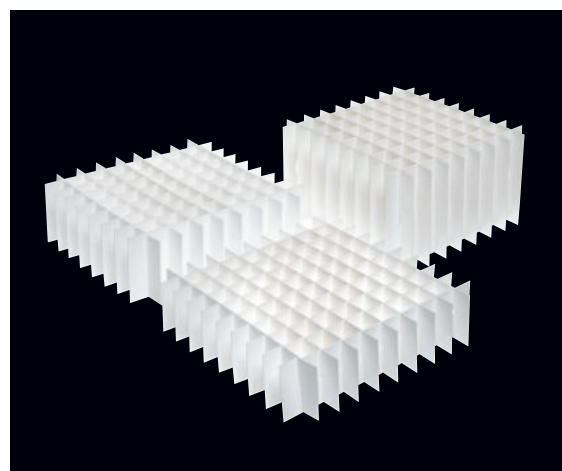

Sample storage system

96 round bottom tubes, supplied in twelve strips of eight tubes each, held in a rack with lid. Rack, lid, tubes and caps are made of **autoclavable** polypropylene, manufactured with the **SBS** standard footprint. Compatible with all robotic applications and multichannel pipetting systems.

Alphanumeric numbered wells, indelibly printed in black, allowing identification in short light conditions. **DNase, RNase, DNA and PCR inhibitors free.**

Used for serial dilutions, mixing, storage and harvesting of cells, cell growth for cell culture assays and DNA screening, and as an ideal long-term storage system. Caps are sold separately in strips of eight units; every cap has a tag to make an easy opening and closing.

Tube dimensions (height): 8 x 44 mm

Rack dimensions (with lid): 128 x 86 x 48 mm

code	description	case quantity	case weight	case volume
409009	rack with 96 tubes (8 x 12)	10	1,63	0,010
409010	strips of 8 tubes each	125 strips	0,27	0,007
409011	strips of 8 caps each	125 strips	0,11	0,012
409012	loose tubes	1.000	0,63	0,005
409013	strips of 12 tubes each	80	0.126	0.001
409014	strips of 12 tubes each	80	0.662	0.006



Sample storage system

Compact sample storing system. It consists on a blue rack with a translucent lid, holding 96 loose round bottom tubes (1,2 ml) arranged in 8 x 12. Robotics suitable version (**RC845TP**). **Autoclavable** and stackable, it resists up to **-100 °C**, and embodies a moulded alphanumeric identification.

Rack, lid and tubes made of polypropylene. Caps made of low density polyethylene.

Caps are sold apart in strips of eight units; every cap has a tag to make an easy opening and closing.

Tube dimensions (height, closed): 8,8 x 45 mm.

Rack dimensions (with lid): 118 x 82 x 50 mm.

DNase, RNase free. *Pyrogen Free.

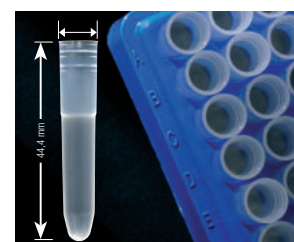

mod.	code	description	case quantity	case weight	case volume
1	409008	rack with 96 tubes (8 x 12)	10	1,40	0,007
2	RC845TP*	rack with 96 tubes for robotics	10	1,14	0,010
	409005	strips of 8 caps each	120 strips	0,16	0,002
	845	tubes in bulk	1.000	0,60	0,004

Sample storage system

It consists on a white rack and a transparent lid, with 96 tubes (12 x 8) 1.2 ml (capped, 1.1 ml).

Tubes and rack are manufactured in polypropylene, being autoclavable.

Caps in non **autoclavable** polyethylene.

Caps are acquired apart, in strips on eight units.

It is ideal to work with robots and multichannel pipetting systems, as well as for sample transport, storage, or freezing (it can withstand up to **-80 °C**).

It stands up the majority of chemical agents.

Both lid and rack embody an alphanumeric identification.

The top left edge of the lid is cut for an exact orientation.

Tube dimensions (capped): 9 x 48 mm.

Rack dimensions (with lid): 126 x 81 x 53 mm.

According to **SBS** standard.

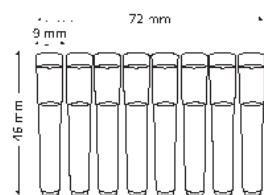

code	description	case quantity	case weight	case volume
409004	rack with 96 tubes (8 x 12)	10	1,80	0,009
408002	tubes of 8 caps each	120 strips	0,73	0,005
408005	strips of 8 caps each	120 strips	0,09	0,001
408003	loose tubes	5 x 960	3,88	0,028



Storage rack with 2 ml tubes

Compatible with most robotic Workstation, this polypropylene storage rack can be used with most cell harvesters and multichannel pipettors.

It contains 96 removable polypropylene square tubes in a 8 x 12 configuration, each having a 2.1 ml capacity.

Although the tubes are square, the bottom is round to facilitate emptying.

Tubes and rack are **autoclavable** and they are ideal for storage of blood and other biological samples at temperatures from **-30°C up to 70°C**.

Racks are stackable to save storage space.

According to **SBS** standard.

code	description	case quantity	case weight	case volume
418003	96 well storage rack with tubes	10	1,81	0,012



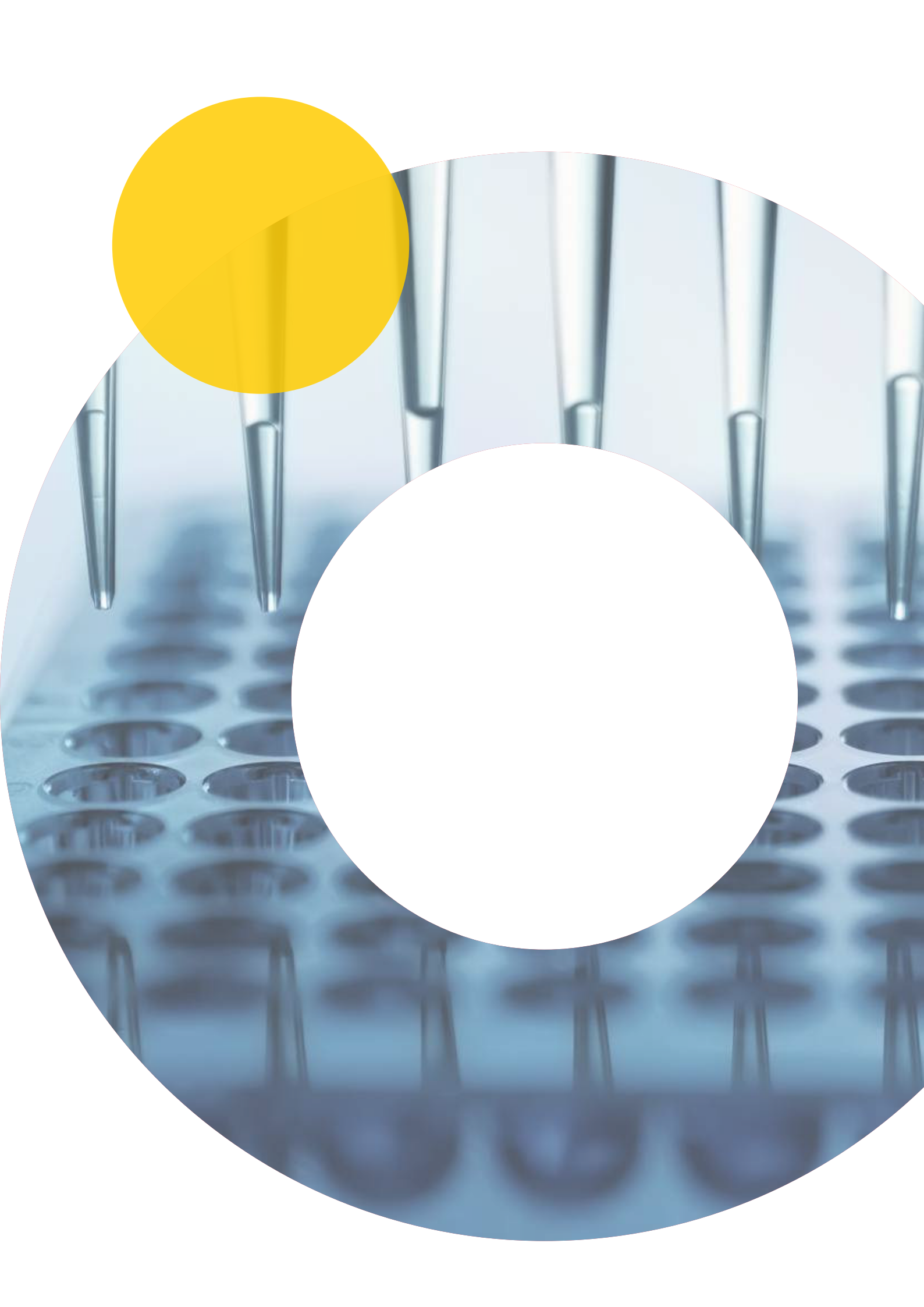

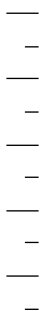
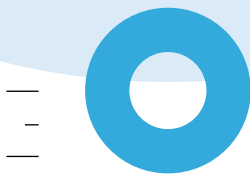
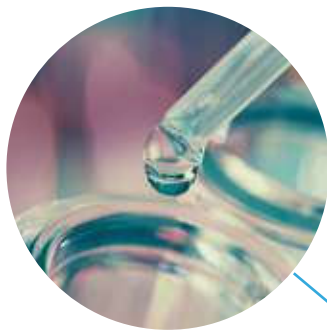

LIQUID HANDLING

 deltalab

Our range

Our range of tips meet almost every liquid handling need, as they are available in a wide scope of options:

- With or without filter in bulk or rack (with hinged, sliding, or free lid).
- Sterile, DNase and RNase free, with Standard or Extra filter, in rack.
- Sterile, without filter, packed in individual bag.

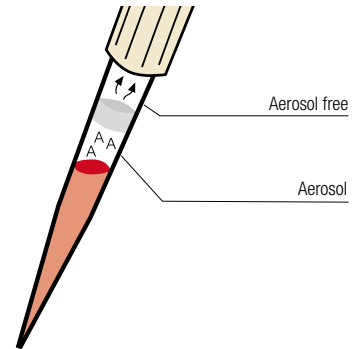
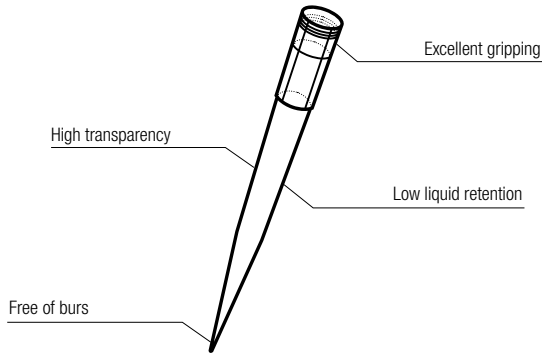

Tips without filter

The perfect aid for a **safe, easy, quick and accurate** liquid handling.

- Low retention
- Autoclave resistant
- Good subsection
- High transparency
- Uniformity
- Free of metals
- Traceability

Tips with filter

The filter tip avoids aerosols and prevents pipette and / or sample contamination.

1. It **purifies the air** that goes through the filter, **removing aerosol and contaminants**
2. It partially **absorbs the sample** in case of overaspiration (10-20%)
3. It **protects the sample** from an accidentally **non sterile pipette**

Our racks are made of **autoclavable** polypropylene.

Types of presentation



Tips in bulk



Individually wrapped flow-pack



Rack for tips



Rack for long tips



Rack for macro tips

0.1 - 10 µl tip

Natural colour universal crystal tip, graduated. Gilson® type.
El Rack made of **autoclavable** polypropylene up to **121 °C**.

Suitable (not exclusive)

Gilson®, Eppendorf®, Biohit®, Dsg®, Elkay®, Finnpiquette®,
Genex®, Jencons®, Nichiryo®, HTL®.



code	description	sterile	case quantity	case weight	case volume
● 200024	tips in bulk	no	20 x 1,000	3.80	0.026
● 199084RC	96 tips rack	no	10 x 96	1.92	0.009
● 326-19	filter tips in bulk	no	20 x 1,000	3.70	0.026
● ● ● 327-19	96 tips rack filter	STERILE R	10 x 96	1.26	0.010

Code 326-19 minimum unit sale: 1 bag..



0.1 - 10 µl tip

Natural colour universal crystal tip, graduated. Gilson® type.
Long shape, perfect to pipette samples in deep vessels.
Rack made of **autoclavable** polypropylene up to **121 °C**.

Suitable (not exclusive)

Gilson®, Socorex®, Eppendorf®, Biohit®, Nichiryo®,
Finnpiquette®, Dsg®, Elkay®, Genex®, Jencons®, HTL®.



code	description	sterile	case quantity	case weight	case volume
● 301-01	tips in bulk	no	15 x 1,000	3.00	0.026
● 301-01R	96 tips rack	no	10 x 96	1.80	0.010
● 301-01F	filter tips in bulk	no	15 x 1,000	2.92	0.023
● ● ● 301-01FR	96 tips rack filter	STERILE R	10 x 96	1.25	0.012

Tips in bulk: minimum unit sale: 1 bag.

Code 301-01F suitable for Eppendorf® Research Plus.



0.5 - 20 µl tip

Natural colour universal crystal tip, bevelled. Eppendorf® type.
Rack made of **autoclavable** polypropylene up to **121 °C**.

Suitable (not exclusive)

Eppendorf®, Gilson®, Biohit®, Brand®, Dsg®, Elkay®,
Finnpiquette®, Jencons®, Nichiryo®, Socorex®, HTL®.



code	description	sterile	case quantity	case weight	case volume
● 301-11	tips in bulk	no	25 x 1,000	4.80	0.050
● 301-10	96 tips rack	no	10 x 96	1.82	0.009
● ● ● 301-09	96 tips rack	STERILE R	10 x 96	1.80	0.009
● 326-37	filter tips in bulk	no	25 x 1,000	5.40	0.035
● ● ● 327-37R	96 tips rack filter	STERILE R	10 x 96	1.25	0.010

Tips in bulk: minimum unit sale: 1 bag.

Colour codes:

● RNase and DNase free ● Metal free ● Pyrogen free





2 - 20 µl tip

Natural colour universal tip. Eppendorf® type.

Available without filter (2-200µl).

See our codes **200072**.

Rack made of **autoclavable** polypropylene up to **121 °C**.

Suitable (not exclusive)

Eppendorf®, Biohit®, Finnpiquette®, Gilson®, Socorex®, Brand®, HTL®.



code	description	sterile	case quantity	case weight	case volume
● ● ● 200010FR	96 tips rack filter	STERILE R	10 x 96	2.00	0.010



2 - 30 µl tip

Natural colour universal filter tip, bevelled.

Gilson® type. Identical to the code 200078 (page 181).

Rack made of **autoclavable** polypropylene up to **121 °C**.

Suitable (not exclusive)

Gilson® P20 P100 P200, Eppendorf®, Biohit®, Dsg®, Elkay®, Finnpiquette®, Genex®, Jencons®, Socorex®, Nichiryo®, HTL®, etc.



code	description	sterile	case quantity	case weight	case volume
● 327-36	filter tips in bulk	no	25 x 1,000	9.50	0.071
● ● ● 327-36R	96 tips rack filter	STERILE R	10 x 96	1.59	0.009

Tips in bulk: minimum unit sale: 1 bag.



2 - 100 µl tip

Natural colour universal filter tip, bevelled.

Gilson® type. Identical to the code 200078 (page 181).

Rack made of **autoclavable** polypropylene up to **121 °C**.

Suitable (not exclusive)

Gilson® P100 P200, Eppendorf®, Biohit®, Dsg®, Elkay®, Finnpiquette®, Genex®, Jencons®, Nichiryo®, HTL®, etc



code	description	sterile	case quantity	case weight	case volume
● 327-23	filter tips in bulk	no	25 x 1,000	9.00	0.071
● ● ● 327-24	96 tips rack filter	STERILE R	10 x 96	1.96	0.010

Tips in bulk: minimum unit sale: 1 bag.

Colour codes:

● RNAse and DNase free ● Metal free ● Pyrogen free

2 - 200 µl tip

Natural colour universal tip, bevelled. Gilson type®.
Rack made of **autoclavable** polypropylene up to **121 °C**; with transparent lid and blue base.

Suitable (not exclusive)

Gilson® P20 P100 P200, Eppendorf®, Biohit®, Dsg®, Elkay®, Finnpiquette®, Genex®, Jencons®, Socorex®, Nichiryo®, HTL®, etc.



code	description	sterile	case quantity	case weight	case volume
● 200078	tips in bulk	no	25 x 1,000	9.20	0.071
● 199078RC	96 tips rack	no	10 x 96	1.96	0.009
● ● ● 199078N	96 tips rack	STERILE R	10 x 96	1.96	0.009

Tips in bulk: minimum unit sale: 1 bag.



5 to 100/200 µl tip

Natural colour universal tip. Eppendorf® type.
Rack made of **autoclavable** (up to 121 °C) polypropylene.

Suitable (not exclusive)

Eppendorf®, Gilson®, Brand®, Biohit®, Dsg®, Elkay®, Finnpiquette®, Genex®, Jencons®, Kartell®, Nichiryo®, Socorex®, HTL®.



code	description	sterile	case quantity	case weight	case volume
● 327-33	tips in bulk	no	25 x 1,000	10.00	0.071
● ● ● 327-33R	96 tips rack filter	STERILE R	10 x 96	1.97	0.010

5 - 100 µl filter tip

5 - 200 µl tip

● 200072	tips in bulk	no	25 x 1,000	9.10	0.071
● 199014RC	96 tips rack	no	10 x 96	1.93	0.010
● ● ● 199014N	96 tips rack	STERILE R	10 x 96	1.97	0.010

Tips in bulk: minimum unit sale: 1 bag.



2 - 200 µl tip

Universal tip, bevelled. Gilson® type. Tips with filter: natural colour.
Tips without filter: yellow colour.
Rack made of **autoclavable** (up to 121 °C) polypropylene.

Suitable (not exclusive)

Gilson®, Eppendorf®, Dsg®, Elkay®, Finnpiquette® (except Multichannel), Genex®, Jencons®, Nichiryo®, HTL®, Socorex® serie Akura.



code	description	sterile	case quantity	case weight	case volume
● 327-34	filter tips in bulk	no	25 x 1,000	9.20	0.083
● ● ● 327-34R	96 tips rack filter	STERILE R	10 x 96	1.45	0.010

Yellow colour:

● 200016	tips in bulk	no	25 x 1,000	8.81	0.072
● 200016B	single tips individually wrapped	STERILE R	200	0.19	0.002
● 200016R	96 tips rack	no	10 x 96	1.94	0.009

Code 327-34 minimum unit sale: 1 bag.



Colour codes:

● RNase and DNase free ● Metal free ● Pyrogen free



0.1 - 200 µl tip

Universal natural colour tip with collar for gel.
Translucent rack made of **autoclavable** polypropylene with hinged lid.

Suitable (not exclusive)

Pipetman®, Eppendorf®, Titertek®, Biohit®, Socorex®, Nichiryo®, Costar Corning®, Oxford®, Rainin®, Finnpiquette®.



code	description	sterile	case quantity	case weight	case volume
● 200079	tips in bulk	no	10 x 1,000	9.20	0.050
● ● ● 200079R	96 tips rack	STERILE R	10 x 96	1.20	0.010
● ● ● 200079FS	96 tips rack filter 0.1-100 µl	STERILE R	10 x 96	1.80	0.010

Tips in bulk: minimum unit sale: 1 bag.



1 - 200 µl tip

Universal natural colour tip with 91 mm length.
Rack made of polypropylene **autoclavable** up to **121 °C**.
Transparent lid and blue base, with 204 tips in 12 x 17 distribution.

Suitable (not exclusive)

Pipetman®, Eppendorf®, Nichiryo®, Costar Corning®, Oxford®, Volac®, Socorex®, Titertek®, SMI®, Rainin®, Finnpiquette®, etc.
Contiene 204 puntas dispuestas en 12 x 17.



code	description	sterile	case quantity	case weight	case volume
● 200026	tips in bulk	no	5 x 1,000	3.50	0.050
● ● ● 327-26	204 tips rack filter	STERILE R	8 x 204	2.23	0.014

Tips in bulk: minimum unit sale: 1 bag.

Colour codes:

- RNase and DNase free
- Metal free
- Pyrogen free

1 - 200 µl tip

Natural colour universal tip. Designed to work with viscous fluids like glycerol or thick tissue homogenates. Suitable also for fragile cellular structures, minimizing the risk of tearing or rupture.

Suitable (not exclusive)

Eppendorf®, Socorex®, Nichiryo®, Finnpiquette®, Biohit®, Oxford®, Pipetman®, Rainin®, Costar Corning®, Volac®.



code	description	sterile	case quantity	case weight	case volume
● 327-40	tips in bulk	no	10 x 1,000	4.20	0.020

Minimum unit sale: 1 bag.



5 - 200 µl tip

Eppendorf® universal tip.
Rack made of **autoclavable** polypropylene up to 121 °C.

Suitable (not exclusive)

Eppendorf®, Gilson®, Brand®, Biohit®, Dsg®, Elkay®, Finnpiquette®, Genex®, Jencons®, Nichiryo®, Socorex®, HTL®.



code	description	sterile	case quantity	case weight	case volume
● 200009	tips in bulk	no	25 x 1,000	8.75	0.072
● 200009B	single tips individually wrapped	STERILE R	200	0.19	0.002
● 200009R	96 tips rack	no	10 x 96	1.98	0.009



5 - 200 µl tip

Yellow universal tip, Gilson® type.

Suitable (not exclusive)

Gilson®, Eppendorf®, Biohit®, Dsg®, Elkay®, Finnpiquette®, Genex®, Jencons®, Nichiryo®, HTL®.



code	description	sterile	case quantity	case weight	case volume
● 199083	tips in bulk	no	25 x 1,000	9.00	0.071

Minimum unit sale: 1 bag.



Colour codes:

- RNase and DNase free
- Metal free
- Pyrogen free



2 - 300 µl tip

Natural colour universal tip. Biohit® type.
Rack made of **autoclavable** polypropylene up to **121 °C**.

Suitable (not exclusive)

Gilson® P200, Finnpiquette® (old model), Labsystems®, etc.



	code	description	sterile	case quantity	case weight	case volume
●	200074	tips in bulk	no	24 x 1,000	8.30	0.067
●	199076RC	96 tips rack	no	10 x 96	1.82	0.010

Tips in bulk: minimum unit sale: 1 bag.



2 - 200 µl tip

Yellow universal tip with crown and with a 50 µl margin to prevent any accidental overaspiration. Translucent rack made of **autoclavable** polypropylene up to **121 °C**; with hinged lid.

Suitable (not exclusive)

Eppendorf®, Socorex®, Gilson® except NEO model, Nichiryo®, Biohit®, Brand®, Jencons®, Thermo®, DSG®, Elkay®, HTL®, Finnpiquette®, Genex®.



	code	description	sterile	case quantity	case weight	case volume
●	200076	tips in bulk	no	24 x 1,000	8.82	0.071
●	200076R	tips in bulk	no	10 x 96	1.98	0.010
● ● ●	200076RF	filter tips in rack	STERILE R	10 x 96	2.04	0.010

Tips in bulk: minimum unit sale: 1 bag.



5 - 200 µl tip

Natural colour universal tip, bevelled. MLA® type.
Translucent rack made of **autoclavable** polypropylene up to **121 °C**; with hinged lid.



	code	description	sterile	case quantity	case weight	case volume
●	200017	tips in bulk	no	25 x 1,000	10.50	0.071

Tips in bulk: minimum unit sale: 1 bag.

Colour codes:

- RNAse and DNase free
- Metal free
- Pyrogen free

5 - 200 µl tip

Natural colour universal tip, bevelled. Oxford® type.
 Suitable for the DiaMed-Micro typing System machine.
 Translucent rack made of **autoclavable** polypropylene up to **121 °C**; with hinged lid.



code	description	sterile	case quantity	case weight	case volume
● 200019	tips in bulk	no	12 x 1,000	6.90	0.071

Tips in bulk: minimum unit sale: 1 bag.



20 - 300 µl tip

Natural colour universal tip. Eppendorf® type.
 Rack made of **autoclavable** (up to **121 °C**) polypropylene.
Suitable (not exclusive): Eppendorf®, Gilson®, Brand®, Biohit®, Elkay®, Jencons®, FinnpiPETTE®, Nichiryo®, Socorex®.



code	description	sterile	case quantity	case weight	case volume
● 200077	tips in bulk	no	20 x 1,000	9.70	0.071
● 200077R	96 tips rack	no	10 x 96	1.94	0.009
● 200077F	filter tips in bulk	no	20 x 1,000	9.90	0.071
● ● ● 200077FR	96 tips rack filter	STERILE R	10 x 96	1.92	0.009

Tips in bulk: minimum unit sale: 1 bag.



50 - 1,000 µl tip

Universal tip with collar. Blue or natural colour.
 Rack made of polypropylene, **autoclavable** up to **121 °C**.
Suitable (not exclusive): Eppendorf®, Gilson®, Biohit®, DSG®, Elkay®, FinnpiPETTE®, Genex®, Jencons®, Nichiryo®. Suitable for Menarini®.



code	description	sterile	case quantity	case weight	case volume
Blue colour:					
● 200012	tips in bulk	no	10 x 1,000	7.95	0.085
● 200012B	single tips individually wrapped	STERILE R	175	0.27	0.004
● 200012R	96 tips rack	no	10 x 96	2.36	0.010
Natural colour:					
● 200070	tips in bulk	no	10 x 1,000	8.00	0.083
● 200070R	96 tips rack	no	10 x 96	2.40	0.009
● ● ● 200070NR	96 tips rack	STERILE R	10 x 96	2.38	0.010
● 327-30	filter tips in bulk	no	10 x 1,000	8.50	0.083
● ● ● 327-30R	96 tips rack filter	STERILE R	10 x 96	1.99	0.010

Codes 200070, 200012 and 327-30 minimum unit sale: 1 bag.

Colour codes:

- RNase and DNase free
- Metal free
- Pyrogen free





50 - 1250 µl tip

(50-1000 µl filter tips).

Natural colour universal tip.

Rack made of polypropylene, **autoclavable** up to **121 °C**.

Suitable (not exclusive): Socorex®, Gilson®, Nichiryo®, Brand®, HTL®, Biohit®, Eppendorf® Research, DSG®, Elkay®, Finnpiquette®, Handrop®.



code	description	sterile	case quantity	case weight	case volume
● 200071	tips in bulk	no	10 x 1,000	8.50	0.083
●●● 200071NR	96 tips rack	STERILE R	10 x 96	2.50	0.010
●●● 327-31R	96 tips rack filter	STERILE R	10 x 96	2.80	0.010

Tips in bulk: minimum unit sale: 1 bag.

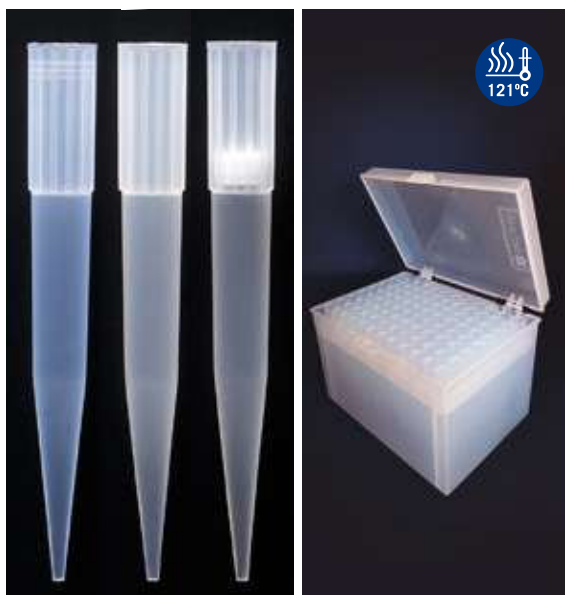

100 - 1,000 µl tip

Gilson® Universal tip. Rack made of polypropylene, **autoclavable** up to **121 °C**.

Suitable (not exclusive): Gilson®, Eppendorf®, Biohit®, DSG®, Elkay®, Finnpiquette®, Genex®, Jencons®, Nichiryo®, Socorex®, HTL®.

code	description	sterile	case quantity	case weight	case volume
Blue colour:					
● 200080.1	tips in bulk	no	10 x 1,000	9.96	0.085
● 200080.1R	96 tips rack	no	10 x 96	2.62	0.015
Natural colour:					
● 200082	tips in bulk	no	10 x 1,000	10.80	0.083
● 200082R	96 tips rack	no	10 x 96	2.66	0.015
●●● 200082NR	96 tips rack	STERILE R	10 x 96	2.62	0.013
● 200082F	filter tips in bulk	no	10 x 1,000	11.20	0.083
●●● 327-16	96 tips rack filter	STERILE R	10 x 96	2.19	0.013

Tips in bulk: minimum unit sale: 1 bag.



100 - 1,000 µl tip

Universal tip with collar. Natural colour, Eppendorf® type. Translucent rack made of **autoclavable** polypropylene up to **121 °C**; with hinged lid.

Suitable (not exclusive)

Eppendorf®, Nichiryo®, Biohit®, Brand®, Dsg®, Gilson®, Elkay®, Finnpiquette®, Genex®, Jencons®, HTL®. Suitable for Menarini®.



code	description	sterile	case quantity	case weight	case volume
● 200029	tips in bulk	no	10 x 1,000	8.10	0.083
● 200029R	96 tips rack	no	10 x 96	2.40	0.010
● 200029F	filter tips in bulk	no	10 x 1,000	8.10	0.083
●●● 200029RF	96 tips rack filter	STERILE R	10 x 96	2.40	0.013

Tips in bulk: minimum unit sale: 1 bag.

Colour codes:

- RNAse and DNase free
- Metal free
- Pyrogen free

5 - 1,000 µl tip

Universal natural colour tip. Beckmann® type.

For use (but not limited to)

Sherwood®, Lancer®.

code	description	sterile	case quantity	case weight	case volume
● 200021	tips in bulk	no	10 x 1,000	6.90	0.071

Minimum unit sale: 1 bag.

**100 - 1,000 µl tip**

Universal tip. Oxford® type.

For use (but not limited to)

Finnpipette®, Labssystem®

code	description	sterile	case quantity	case weight	case volume
● 200020	tips in bulk	no	8 x 1,000	10.40	0.071

Minimum unit sale: 1 bag.

**200 - 1,000 µl tip**

Natural colour universal tip special for MLA®. Bevelled.

Suitable (not exclusive)

Finnpipette® colour.

code	description	sterile	case quantity	case weight	case volume
● 200018	tips in bulk	no	8 x 1,000	2.75	0.071

Minimum unit sale: 1 bag.



Colour codes:

● RNase and DNase free ● Metal free ● Pyrogen free



Pipetting reservoir

Reservoir specially designed for use with multichannel pipettes. Made of polystyrene. Code M-210 is supplied **sterile by radiation and individually wrapped**.



See our plates for liquid handling on chapter **Cell culture. Molecular biology**



code	description	sterile	case quantity	case weight	case volume
M-203	25 ml	no	5 x 10	0.72	0.005
M-212	25 ml	no	100	0.82	0.008
M-213	25 ml	STERILE R	100	1.37	0.050
M-201	100 ml	no	100	1.16	0.0019
M-211	100 ml	STERILE R	100	1.99	0.060



Pipetting reservoir

8 and 12 channel reservoir, 48 ml, PS, **sterile by radiation**. Individually wrapped.

Dimensions:

330089: 83 x 126 x 13 mm

330129: 126 x 83 x 13 mm

code	description	sterile	case quantity	case weight	case volume
330089	8 channel, 48 ml	STERILE R	10	0.23	0.004
330129	12 channel, 48 ml	STERILE R	10	0.23	0.004



Double-sided pipetting reservoir

Double-sided reagents reservoir.

By one side is a multichannel reservoir that allows pipetting up to 12 different reagents and by the other side is an only reservoir to use with one reagent type. Easy pour-spouts.

Its tapered reservoir bottoms form into a narrow trough to aid full sample recovery. It also has tabs to prevent stacked reservoirs from sticking together. It incorporates a lid (1).



code	description	case quantity	case weight	case volume
M-205	Double-sided reagents reservoir	25	1.07	0.008

1 - 5 ml macrotip

Natural colour universal macro tip, with collar. Eppendorf® type.
Rack made of polypropylene **autoclavable** up to **121 °C**. Polycarbonate transparent lid and marble base.
Sliding lid.

For use (but not limited to)

Biohit®, Dsg®, Eppendorf®, Genex®, Jencons®, Socorex® Acura 835.



code	description	sterile	case quantity	case weight	case volume
● 200075	tips in bulk	no	8 x 250	5.90	0.088
● 199075	50 tips rack	no	4 x 50	1.98	0.015
● ● ● 200075RF	50 tips rack filter	STERILE R	4 x 50	2.50	0.015



1 - 5 ml macrotip

Natural colour universal macro tip with collar. Socorex® type.

For use (but not limited to) Nichiryo®, Oxford®.

código	descripción	estéril	cantidad caja	peso caja	volumen caja
162005*	tips in bulk	no	14 x 250	9.80	0.096
662005	single tips individually wrapped	STERILE R	250	0.90	0.009

* Minimum unit sale: 250.

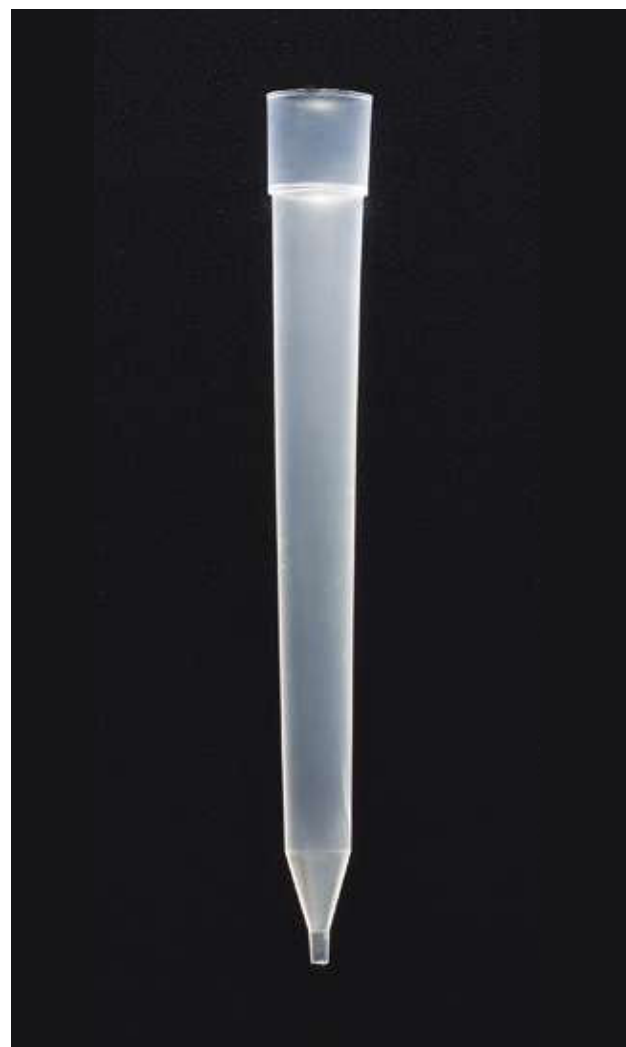

Colour codes:

● RNase and DNase free ● Metal free ● Pyrogen free

1 - 5 ml macrotip

Blue colour universal macro tip with collar. Socorex® type.
Rack made of polypropylene **autoclavable** up to **121 °C**.
Transparent lid and marble base. Sliding lid.

For use (but not limited to) Gilson®, Nichiryo®.

code	description	sterile	case quantity	case weight	case volume
● 200083	tips in bulk	no	8 x 250	5.78	0.085
● 200083R	50 tips rack	no	4 x 50	2.10	0.015

* Except Nichiryo 3100 and 5000DG.

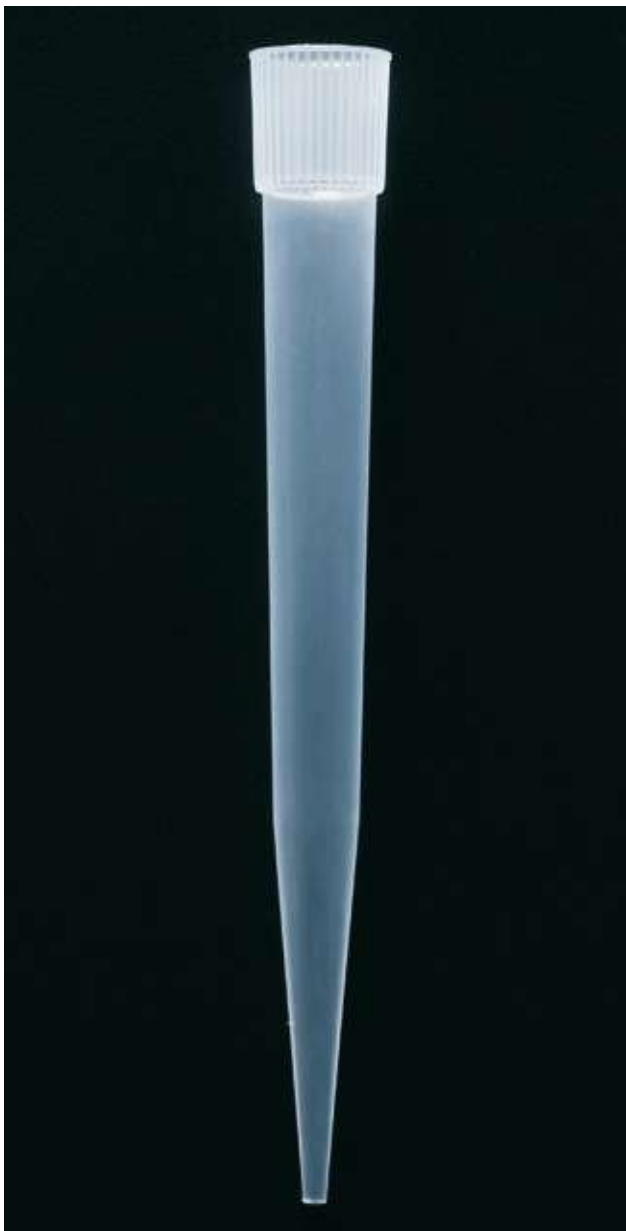

1 - 5 ml macrotip

Natural colour universal macro tip with collar. Finnipipette® type.
Rack made of polypropylene **autoclavable** up to **121 °C**.
Transparent lid and marble base. Sliding lid.

For use (but not limited to) Brand®, Labssystem®.

code	description	sterile	case quantity	case weight	case volume
● 200028	tips in bulk	no	8 x 250	6.76	0.085
● 200028R	50 tips rack	no	4 x 50	2.20	0.015
● ● ● 200028RF	50 tips rack filter	STERILE R	4 x 50	2.50	0.015



Colour codes:

- RNAse and DNase free
- Metal free
- Pyrogen free

2 - 10 ml macrotip

Natural colour universal macro tip with collar. Gilson® type. Rack made of polypropylene **autoclavable** up to **121 °C**. Transparent lid and marble base. Sliding lid.

For use (but not limited to) Labsystem®, Socorex®.

code	description	sterile	case quantity	case weight	case volume
● 200015	tips in bulk	no	10 x 100	7.24	0.087
● 200015R	25 tips rack	no	4 x 25	2.25	0.015
● ● ● 200015RF	25 tips rack filter	STERILE R	4 x 25	2.20	0.015



2 - 10 ml macrotip

Macro tip for Eppendorf®, Biohit® and Gilson® electronic pipettes.

For use (but not limited to) Gilson Electronic 10000®, Biohit® electronic.

code	description	sterile	case quantity	case weight	case volume
● 200014	tips in bulk	no	10 x 100	7.24	0.087
● 200014R	25 tips rack	no	4 x 25	2.25	0.015
● ● ● 200014FR	25 tips rack filter	STERILE R	4 x 25	2.20	0.015



Colour codes:

● RNAse and DNase free

● Metal free

● Pyrogen free



Multitips extra

Available in different capacities.
 Graduation in different colors according to volume.
 Each 25 ml and 50 ml box contains a free adapter.

Suitable for (non exclusive)

Biohit® eLine® Lite y Pro, Brand® HandyStep electronic, Eppendorf® Repeater Plus, Multipette® Pro, y Multipette® 4780, Nichimate® Stepper (Nichiry®), Gilson® Distriman, StepMate®, Ripette®, etc.

When used with Multipette® plus and Multipette® pro the dispenser display is not operational.
 Non sterile product.



code	description	colour	case quantity	case weight (kg)	case volume (m ³)
317-314.1	Multitips 1.0 ml	●	100	0.37	0.006
317-315.1	Multitips 2.5 ml	●	100	0.48	0.006
317-316.1	Multitips 5 ml	●	100	0.51	0.006
317-317.1	Multitips 10 ml	●	100	0.62	0.006
317-318.1	Multitips 25 ml	●	25	0.46	0.006
317-319.1	Multitips 50 ml	●	25	0.51	0.006

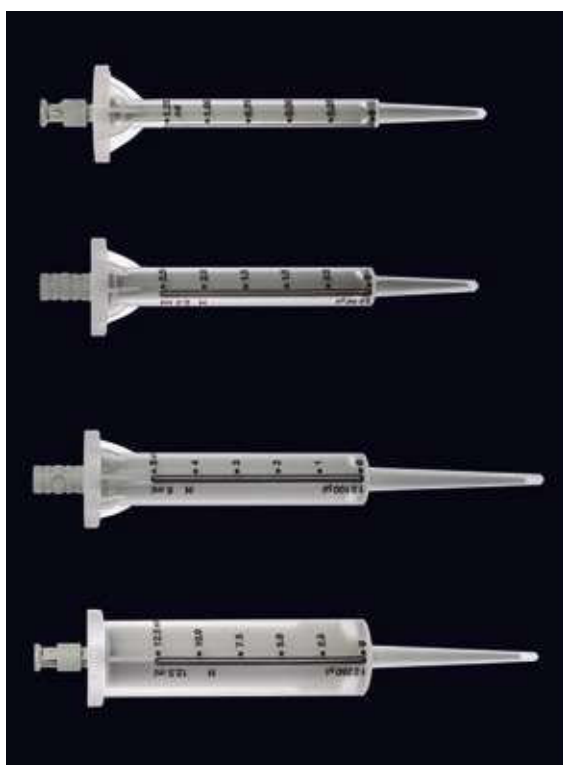

Multitips

Available in seven capacities in sterile and non-sterile version.
 Graduation in black color.

Suitable for (non exclusive)

Eppendorf® Multipette 4780, Brand® Handystep and Handystep Electronic, Nichimate® Stepper, Ripette® and Ripette® GenX, Minilab® 100/101, Stepmate®, Easystep®, Gilson® Distriman®, etc.



sterile models

	code	description	colour	case quantity	case weight (kg)	case volume (m ³)
STERILE R	316-313.2	Multitips 0.5 ml	● ●	100	0.50	0.009
	316-314.2	Multitips 1.25 ml	● ●	100	0.61	0.009
	316-315.2	Multitips 2.5 ml	● ●	100	0.662	0.008
	316-316.2	Multitips 5 ml	● ●	100	0.82	0.008
	316-317.2	Multitips 12.5 ml	● ●	100	1.02	0.009
	316-318.2	Multitips 25 ml	● ●	100	0.48	0.009
	316-319.2	Multitips 50 ml	● ●	100	0.35	0.009
NO STERILE	316-313.1	Multitips 0.5 ml		100	0.37	0.006
	316-314.1	Multitips 1.25 ml		100	0.48	0.006
	316-315.1	Multitips 2.5 ml		100	0.53	0.007
	316-316.1	Multitips 5 ml		100	0.69	0.006
	316-317.1	Multitips 12.5 ml		100	0.87	0.007
	316-318.1	Multitips 25 ml		25	0.48	0.009
	316-319.1	Multitips 50 ml		25	0.51	0.009

Colour codes:

● RNase and DNase free ● Metal free ● Pyrogen free

Other volumes are available under request.

Single channel and variable volume NICHIPET PREMIUM pipettes

Single channel and variable volume NICHIPET PREMIUM pipettes. These pipettes have the same features as NICHIPET EXII, and the following advantages:

Nozzle with a high level of tolerance to abrasion, ceramic piston made of non-corrosive materials, and body made as solvent resistant. 4 position to lock the volume. *HyperBlow* system to improve dispensation efficiency.

Body designed to minimize fatigue and corrosion resistance ejector.

5-year warranty

code	volume range	increments μ l	accuracy %	precision %	case weight	case volume
NPP-2	0.1-2 μ l	0.002	3-12	1-6	0.23	0.0013
NPP-10	0.5-10 μ l	0.01	1-4	0.5-3	0.23	0.0013
NPP-20	2-20 μ l	0.02	1-5	0.4-3	0.23	0.0013
NPP-100	10-100 μ l	0.1	0.8-2	0.3-1	0.23	0.0013
NPP-200	20-200 μ l	0.2	0.8-1	0.2-0.5	0.23	0.0013
NPP-1000	100-1,000 μ l	1	0.7-1	0.2-0.5	0.27	0.0013
NPP-5000	1-5 ml	10	0.6-1	0.2-0.3	0.24	0.0013
NPP-10000	1-10 ml	10	0.4-2	0.2-0.4	0.24	0.0013



Single variable volume NICHIPET EXII

1 Fully autoclavable and UV rays resistant pipettes. Easy digital volume setting. Ceramic piston for volumes bigger than 200 μ l. Easy lock with one hand and thermal insulation of the handle. Easy calibration. PTFE Chamber that maintains its tightness and reproducibility for a long time.

2 Model EXII Plus is specifically designed for using with chemical solvents without any danger of corrosion. A Perfluoro rubber O-ring is installed in NICHIPET EXII Plus.

code EXII	volume range	increments μ l	accuracy %	precision %	case weight	case volume
NPX2-2	0.1-2 μ l	0.002	3-12	1-6	0.22	0.0013
NPX2-10	0.5-10 μ l	0.01	1-4	0.5-3	0.22	0.0013
NPX2-20	2-20 μ l	0.02	1-5	0.4-3	0.22	0.0013
NPX2-100	10-100 μ l	0.1	0.8-2	0.3-1	0.22	0.0013
NPX2-200	20-200 μ l	0.2	0.8-1	0.2-0.5	0.23	0.0013
NPX2-1000	100-1,000 μ l	1	0.7-1	0.2-0.5	0.25	0.0013
NPX2-5000	1-5 ml	10	0.6-1	0.2-0.3	0.28	0.0013
NPX2-10ML	1-10 ml	10	0.4-2	0.2-0.4	0.22	0.0013



Multi Channel Pipette NICHIPET 7000

Autoclavable (121°C for 20 minutes). Enhanced UV resistance for better use in clean benches. Suitable for dispensing to 96 well micro plates. Easy digital volume setting. Easy and convenient single hand locking lever.

The ejector allows for tip ejections without touching the tip.

Revolving handle (360°) to fixate convenient position in pipetting.

code	volume range μ l	channels	increments μ l	case weight	case volume
00-NPM-8L	20 - 200	8	0.2	0.236	0.0013
00-NPM-8K	30 - 300	8	1	0.236	0.0013
00-NPM-12L	20 - 200	12	0.2	0.236	0.0013
00-NPM-12K	30 - 300	12	1	0.236	0.0013

Consult the sales team for other volumes.
All pipettes are made in Japan.





Circular support to house 6 single-channel pipettes

Made of ABS

Non-exclusive compatibility:

Nichipet premium LT, Nichipet Premium, Nichipet EX II, Nichipet EX Plus II and Nichiryo Le.

How to assemble the rotary pipette stand:

1. Screw the pole into the stand
2. Put the hanger stopper to the hole of the hanger first then screw the hanger stopper into the top of the pole.
3. Screw down firmly for the screw portion.
4. Hang the pipettes.

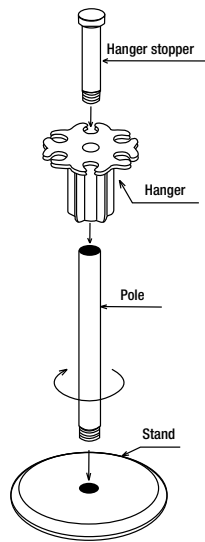

code	case quantity	case weight	case volume
MLTSTD2	1	0.407	0.0057



Handrop® stand for pipettes

The linear and round stands have been designed to fit perfectly Handrop digital pipettes.

The stands are convenient to hold up 6 pipettes both of single and multi-channel.

Dimensions: 287 x 276 x 143 mm.

code	case quantity	case weight	case volume
999802	1	0.40	0.002

Handrop® digital - SC

Single channel variable volume digital pipettes with digital display.
Precise volume selector.
Easy calibration and maintenance.
Lightweight and ergonomic design with tip ejector.

code	volume range μ l	increments μ l	accuracy %	precision %	case weight	case volume
770005	0.1 - 2.5	0.05	2.5 - 12	2 - 5	0.19	0.001
770000	0.5 - 10	0.1	1.0 - 2.5	0.8 - 1.5	0.19	0.001
770080	2 - 20	0.5	0.9 - 3.0	0.4 - 2.0	0.19	0.001
770050	10 - 100	1	0.8 - 3.0	0.15 - 1.5	0.20	0.001
770070	20 - 200	1	0.6 - 3.0	0.15 - 1.0	0.19	0.001
770060	100 - 1,000	5	0.6 - 2.0	0.2 - 0.7	0.20	0.001
770040	200 - 1,000	5	0.6 - 0.9	0.2 - 0.3	0.19	0.001
770110	1 - 5 ml	0.05 ml	0.5 - 0.7	0.15 - 0.3	0.21	0.001



Handrop® digital - MC

8 and 12 channel variable volume digital pipettes with digital display.
Precise volume selector.
Easy calibration and maintenance.
Lightweight and ergonomic design with tip ejector.

code	volume range μ l	increments μ l	accuracy %	precision %	case weight	case volume
8 channels						
770210	0.5 - 10	0.1	1.0 - 4.0	1.5 - 4.0	0.36	0.0015
770220	5 - 50	0.5	1.0 - 3.0	0.5 - 2.0	0.36	0.0015
770240	50 - 300	5	0.7 - 1.5	0.25 - 0.8	0.36	0.0015
12 channels						
770310	0.5 - 10	0.1	1.0 - 4.0	1.5 - 4.0	0.30	0.0015
770320	5 - 50	0.5	1.0 - 3.0	0.5 - 2.0	0.38	0.0015
770340	50 - 300	5	0.7 - 1.5	0.25 - 0.8	0.36	0.0015



Handrop® stepper

Single channel stepper.
Allows to dispense up to 40 different volumes and up to 48 doses.
Compatible with tips on the page 192.
Volumes from 1 μ l to 5 ml can be dispensed.

code	description	case weight	case volume
721008	Handrop Stepper	0.20	0.0015



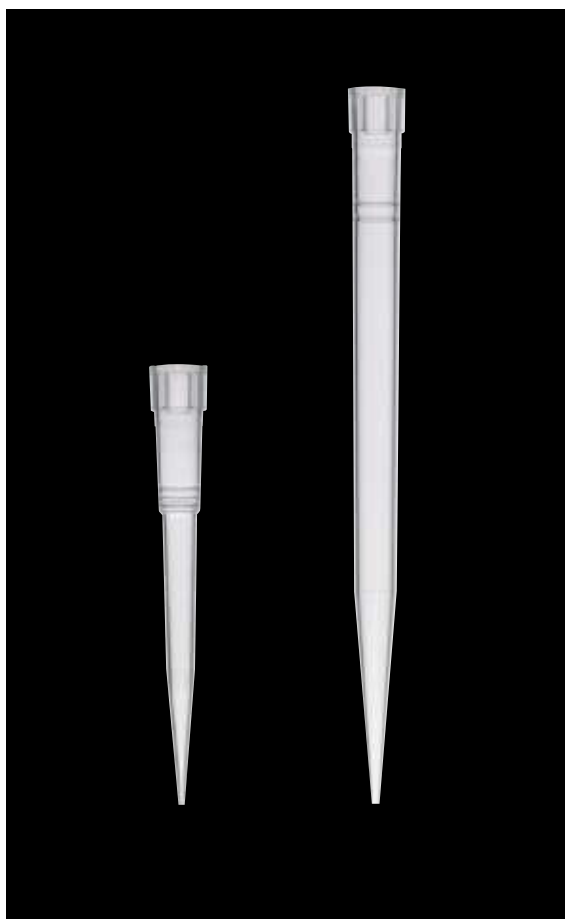

Robotic and conductive tips for TECAN

Manufactured in clean room class ISO 8.

Racks and tips in conductive polypropylene.

Free of DNase, RNase and endotoxins.

High precision tips.

The conductivity allows the system to recognize the filling height and guarantees a minimum immersion of the tip in the liquid, to ensure safe pipetting and dispensing.

The rack has 96 tips.

They are supplied in double package.

Compatible with Tecan Genesis® and Tecan Evo Freedom®.

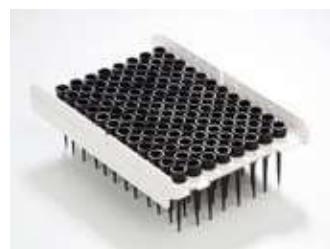
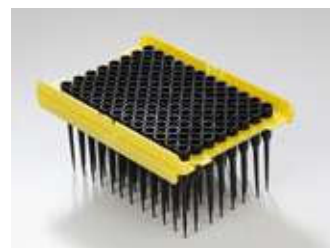

code	description	rack colour	tips number	case quantity	case weight	case volume
318005	10 µl conductive tip	○	96	5 x 2	0.80	0.0045
318006	50 µl conductive tip	●	96	5 x 2	0.80	0.0045
318002	200 µl conductive tip	●	96	5 x 2	0.90	0.0045
318003	1,000 µl conductive tip	●	96	5 x 2	2.00	0.0046
318102	200 µl conductive tip	●	96	5 x 2	0.90	0.0045
318103	1,000 µl conductive tip	●	96	5 x 2	2.00	0.0045

Robotic Tips for Qiagen (300µl and 1,100µl)

Manufactured in clean room class ISO 8.

Racks and tips in conductive polypropylene.

Free of DNase, RNase and endotoxins.

High precision tips. The conductivity allows the system to recognize the filling height and guarantees a minimum immersion of the tip in the liquid, to ensure safe pipetting and dispensing.

The rack has 96 tips.

They are supplied in double package.

Compatible with BEP 2000®, Biorobot®, Elysis Quattro®, Etimax®, Evolis®, Triturus® and others.



code	description	rack colour	tips number	case quantity	case weight	case volume
318000	robotic tip 300 µl	●	96	5 x 2	1.00	0.004
318001	robotic tip 1,100 µl	●	96	5 x 2	1.80	0.0076



Robotic Tips for Hamilton (300µl and 1,000µl)

Manufactured in clean room class ISO 8.

Racks and tips in conductive polypropylene.

Free of DNase, RNase and endotoxins.

High precision tips. The conductivity allows the system to recognize the filling height and guarantees a minimum immersion of the tip in the liquid, to ensure safe pipetting and dispensing.

The rack has 96 tips.

They are supplied in blister of 5.

Compatible with Hamilton Microblab Star®, Nimbus® and Vantage®.



code	description	rack colour	tips number	case quantity	case weight	case volume
318008	robotic tip 300 µl	○	96	5 x 1	0.575	0.005
318009	robotic tip 1,000 µl	○	96	5 x 1	0.9	0.008



Micropipettes

Made in transparent, inert and low density polyethylene. They are used as volume measurers, to incorporate in kits of reagents, pregnancy tests, etc. They can be frozen in liquid nitrogen. Before use, press the upper bulb, filling all the stem, and the rest remains in the inferior bulb, which it is not due to give. Volumetrical tolerance: $\pm 10\%$.

mod.	code	presentation	length mm	dispense volume μl	case weight	case volume
A	201110	500	83.0	100	0.31	0.003
B	201250	500	102.0	250	0.39	0.003



Special purpose pipettes

Made in transparent, inert and low density polyethylene. They can be frozen in liquid nitrogen. Volumetrical tolerance: $\pm 10\%$.

mod.	code	presentation	length mm	\varnothing stem mm	total capacity ml	bulb draw μl	stem draw ml	case weight	case volume
A	210030	8 x 500	130	3.8	0.5	0.2	0.3	2.90	0.023
B	210005	500	50	1.19	1.3	1.0	0.3	1.90	0.022



Graduated pipettes

Made in transparent, inert and low density polyethylene.

Sterile models are ethylene oxide sterilized (except codes **200037** and **200034** that are radiation sterilized).

Volumetrical tolerance: $\pm 10\%$.

mod.	code	presentation	sterile	length mm	Ø stem mm	graduated until ml	total capacity ml	bulb draw ml	stem draw ml	graduations ml	case weight	case volume	pallet quantity
A	200002	10 x 500	no	152	7.1	2	4.8	1.8	3	0.50	7.86	0.099	100,000
B	200006	10 x 500	no	155	7.9	3	7.5	3.2	4.3	0.50	9.65	0.100	100,000
B	200062.0	10 x 500 bag 20 u.	STERILE EO	160	7.8	3	7.0	3.2	3.8	0.50	12.16	0.130	35,000
B	200007	6 x 500 individually wrapped peel-pack	STERILE EO	154	7.8	3	7.0	3.2	3.8	0.50	10.10	0.160	27,000
B	200037	6 x 500 individually wrapped flow-pack	STERILE EO	154	7.8	3	7.0	3.2	3.8	0.50	8.19	0.158	27,000
C	200003	6 x 500	no	155	4.6	1	5.8	3.4	2.4	0.25	5.10	0.061	90,000
C	200032.0	6 x 500 bag 20 u.	STERILE EO	158	5.0	1	5.0	3.1	1.9	0.25	6.48	0.067	48,000
C	200004	6 x 500 individually wrapped peel-pack	STERILE EO	154	5.0	1	5.0	3.1	1.9	0.25	9.23	0.165	27,000
C	200034	6 x 500 individually wrapped flow-pack	STERILE EO	154	5.0	1	5.0	3.1	1.9	0.25	7.07	0.162	27,000



1
2
3

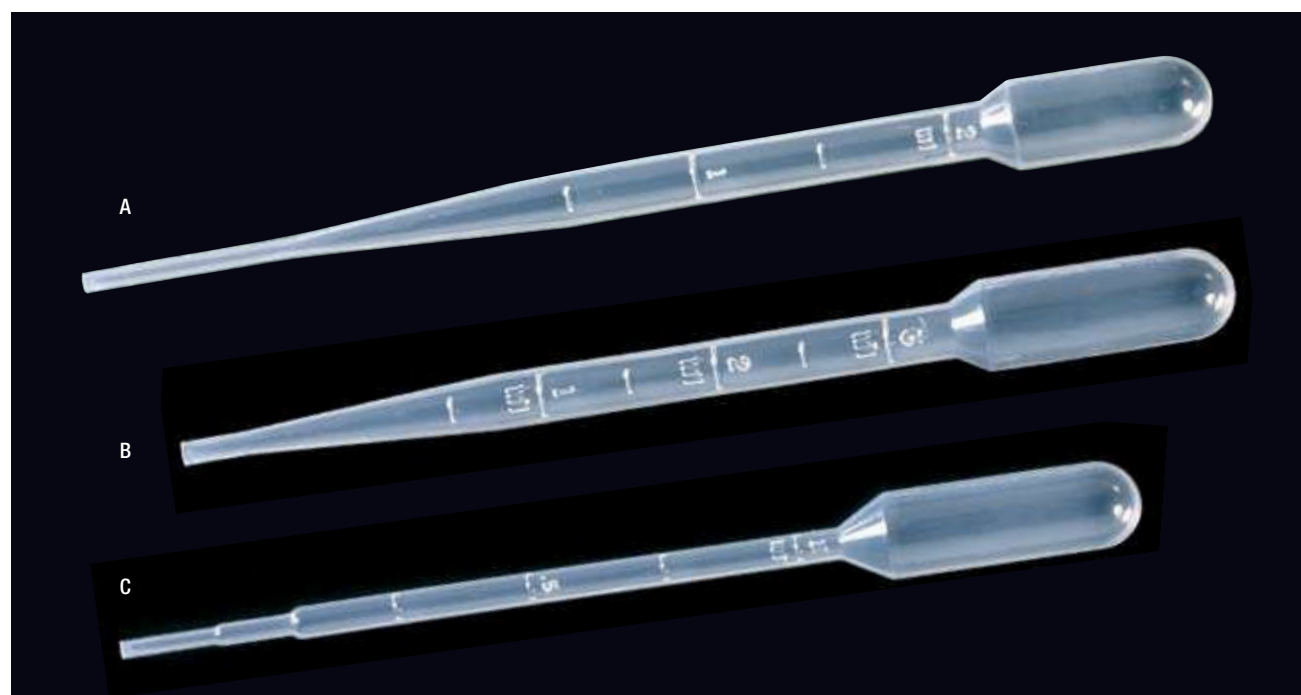

General purpose pipettes

Small volume Pasteur pipettes in transparent, inert and non-toxic inert low density polyethylene (PELD). Low adhesion surface.

The code **200038** is sterile by radiation, while code **200008** is by ethylene oxide.

Volumetric tolerance $\pm 10\%$.

mod.	code	presentation	sterile	length mm	Ø stem mm	total capacity ml	bulb draw ml	stem draw ml	case weight	case volume
A	200121	10 x 1,000	no	67	3.9	1.1	0.5	0.6	4.24	0.051
B	200001	8 x 500	no	87	4.7	1.7	0.9	0.8	3.50	0.038
C	200000	10 x 400	no	150	6.3	8.0	4.6	3.4	8.70	0.096
D	200005	6 x 500	no	155	2.5	4.6	3.3	1.3	4.79	0.060
D	200008	6 x 500 individually wrapped peel-pack	STERILE EO	150	2.5	4.0	3.1	0.9	13.00	0.162
D	200038	6 x 500 individually wrapped flow-pack	STERILE R	150	2.5	4.0	3.1	0.9	13.00	0.162

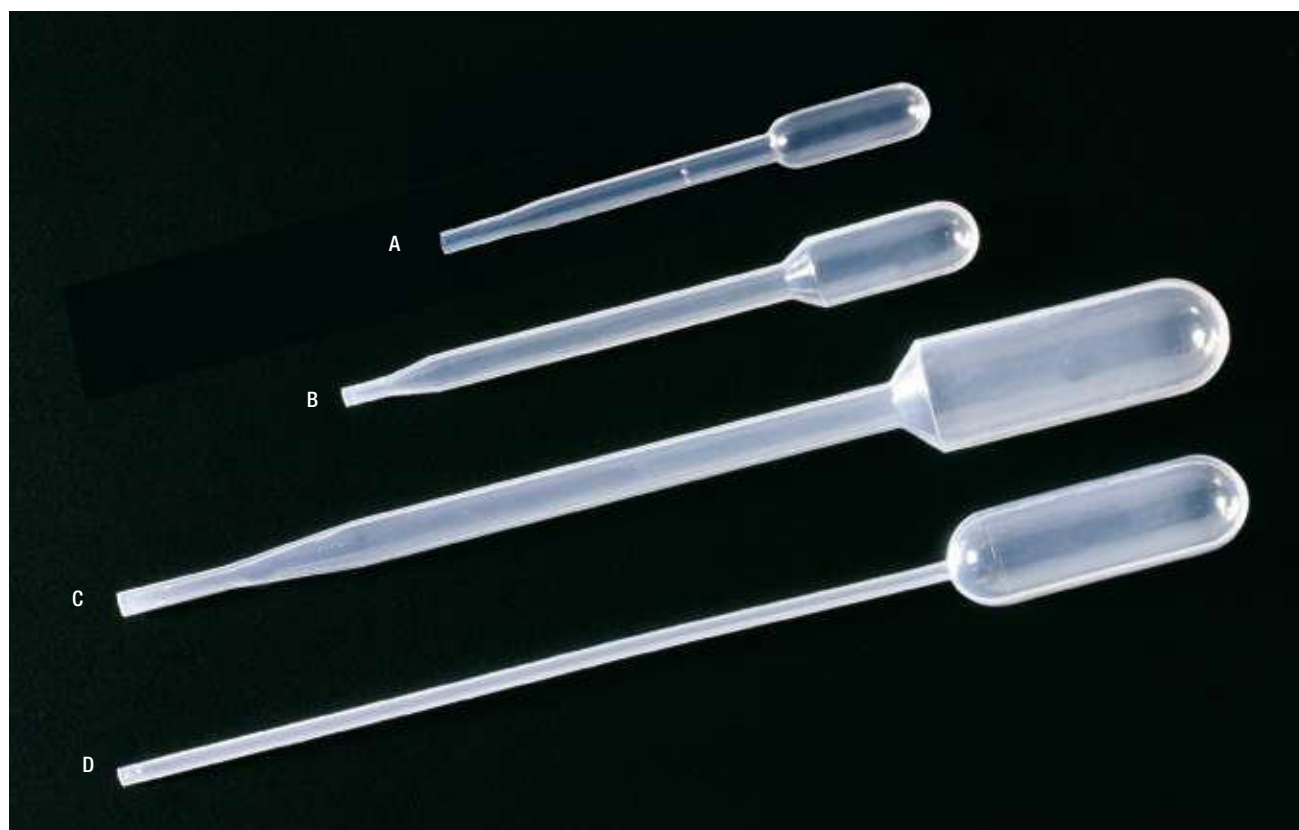

General purpose pipettes

Pasteur pipettes in low density inert polyethylene. (PELD). Low adhesion surface.

Fine tip pipettes, excellent for dispensing micro volumes and small drops.

They can be frozen in liquid nitrogen.

Type of tip:

210003, 210004, 210023 and **210024** have an **extended fine tip**.

210002 and **210022** have a **fine tip**.

210003, 210023, 210022.- Ideal for Kits-Test, for example HIV, pregnancy; serum separation in Paediatrics mainly, chromatography cup filling, microvials, microplates, electrophoresis gels, E.L.I.S.A., etc.

210004.- Ideal for PCR techniques, E.L.I.S.A., DNA samples, protein assays, hybridoma, atomic absorption, and all types of additions in microtechniques, electrophoresis, etc.

Codes **210023, 210022** and **210024** are supplied individually wrapped in a peel-pack sterile by ethylene oxide. On the paper side are printed the product code, batch number and expiry date. Codes **210003, 210002** and **210004** are supplied in non sterile bags.

mod.	code	presentation	sterile	length mm	Ø stem mm	total capacity ml	bulb draw ml	stem draw ml	case weight	case volume
A	210003	8 x 400	no	104	3.0	1.5	1.0	0.5	2.24	0.022
A	210023	500 individually wrapped peel-pack	STERILE EO	104	3.0	1.5	1.0	0.5	1.38	0.027
B	210002	10 x 500	no	144	5.0	5.0	3.3	1.7	7.30	0.099
B	210022	500 individually wrapped peel-pack	STERILE EO	144	5.0	5.0	3.3	1.7	1.66	0.027
C	210004	8 x 250	no	153	3.0	5.5	3.0	2.5	3.30	0.042
C	210024	500 individually wrapped peel-pack	STERILE EO	153	3.0	5.5	3.0	2.5	1.63	0.028



Extra long pipettes

Made in transparent polyethylene. Model **200050** is graduated each ml up to 5 ml. Volumetrical tolerance: $\pm 10\%$.

mod.	code	presentation	length mm	Ø stem mm	total capacity ml	bulb draw ml	stem draw ml	case weight	case volume
A	200050	10 x 250	216	-	13.7	6.2	7.5	8.40	0.110
B	200060	10 x 100	300	9.0	23.0	7.1	15.9	7.60	0.110
C	210006	10 x 400	225	5.0	6.0	2.3	3.7	9.04	0.098



Non graduated serological pipettes. Sterile

Single use, made in polystyrene, without graduation. **In sterile packing by radiation.**

DNase and RNase free, non cytotoxic, non haemolytic, apyrogen. Without cotton.

Standard tip, see picture (A) at the page 193.

Suitable for Integra VacuSafe Comfort and others.

Dimensions:

External tip diameter, between 5.45 - 5.7 mm, internal diameter tip end: between 1.8 - 2.2 mm.

code	capacity ml	presentacion	case quantity	case weight	case volume
900032.1C	2	1 peel-pack	4 x 500	11.30	0.071





ACTUAL SIZE PICTURE

Sterile single use Straw-like pipettes

Single use straw-like non graduated pipettes. In polypropylene. Suitable for automatic pipettes. **Sterilized by radiation.** Packaged in flow packs of 25 units. Outer diameter: 4.35 mm. Inner diameter: 3.65 mm.



code	capacity ml	length mm	case quantity	case weight	case volume
900050	1.0	190	40 x 25	1.19	0.007

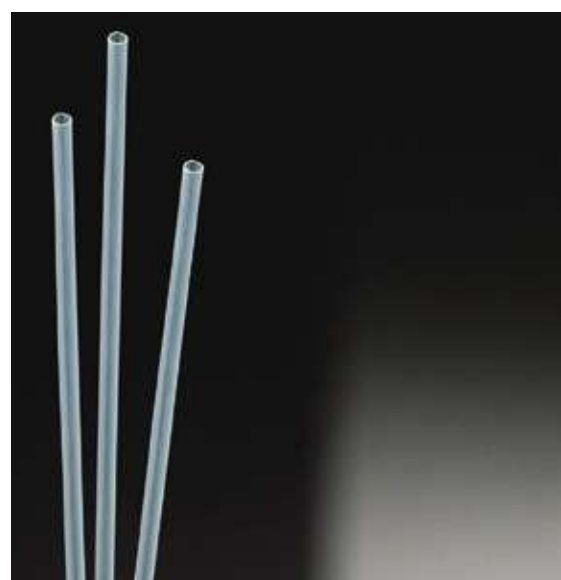

Pipette trays

Made of white PVC.
Resistant to temperatures from **-20 °C to 80 °C.**

Model 1, code **19252**, is perfect to fit inside drawers. It includes four compartments that can hold up to thirty pipettes of 1, 2, 5, or 10 ml.

Model 2, code **19996**. Sixteen pipettes up to 10 mm diameter can be accommodated longitudinally; laterally, seven pipettes up to 20 mm diameter. Tray edges are ergonomically designed for a better handling. It is also useful with other instruments.

mod.	code	dimensions mm	case quantity	case weight	case volume
1	19252	426 x 300 x 30	1	0.53	0.006
2	19996	283 x 216 x 40	6	1.38	0.017



Sterile serological pipettes

Made of glass polystyrene. Single use only.

Serological pipettes have an accuracy of +/- 2% at full scale.

Sterilized by radiation.

Manufactured in one, two or three pieces depending on the volume.

They guarantee maximum precision without liquid retention at the welding level and offer a total dispensing. Pyrogenic, non-cytotoxic and non-hemolytic. Volumes from 1 ml to 50 ml, identified with a polyolefin (does not contain synthetic fibers) white cotton and screen printed in color according to volume.

The peel-pack of the models presented in this way is fiber-free and easy to open. Black graduations, bright and unalterable. Negative scale and double inverted scale (ascending and descending graduations).

DNase and RNase free.

Manufactured in a room with controlled environment, class 100,000.

BSE / TSE free.

This product does not contain latex.

Three models of tips available:

A = TAPE END,

B = WIDE TIP,

C = OPEN TIP

(recommended for viscose samples).

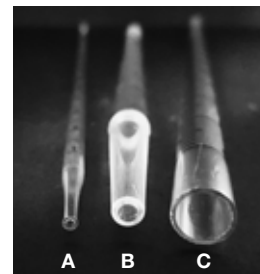

code	capacity ml	presentation	cotton colour	tip	graduation ml	negative graduation ml	total capacity ml	case quantity	case weight	case volume
900030.C	1	1 peel-pack	●	A	0/0.9	until -0.3	1.3	500	2.59	0.019
900031.C	1	bag of 25	●	A	0/0.9	until -0.3	1.3	40 x 25	4.02	0.019
900130.C	1	1 peel-pack	●	C	0/0.9	until -0.3	1.3	500	2.59	0.019
900032.C	2	1 peel-pack	●	A	0/1.8	until -0.6	2.6	500	3.74	0.019
900033.C	2	bag of 25	●	A	0/1.8	until -0.6	2.6	40 x 25	6.70	0.019
900034.C	5	1 peel-pack	●	A	0/4	until -3	8	200	2.42	0.014
900038.C	5	bag of 25	●	A	0/4	until -3	8	20 x 25	6.38	0.019
900144.C	5	1 peel-pack	●	B	0/4	until -3	8	200	2.42	0.014
900036.C	10	1 peel-pack	●	A	0/9	until -3	13	200	2.73	0.014
900037.C	10	bag of 25	●	A	0/9	until -3	13	16 x 25	5.5	0.019
900136.C	10	1 peel-pack	●	C	0/9	until -3	13	200	2.32	0.013
900146.C	10	1 peel-pack	●	B	0/9	until -3	13	200	3.82	0.014
900041.C	25	1 peel-pack	●	A	0/23	until -8	33	150	3.07	0.019
900043.C	50	1 peel-pack	●	A	0/46	until -10	60	100	2.54	0.019

Find trays, rotary stands and other products for pipettes in chapter **Safety and General Labware**



See our plastic Pasteur pipettes in chapter **Liquid Handling**



Please find racks for these tubes in chapter **Sample Storage**

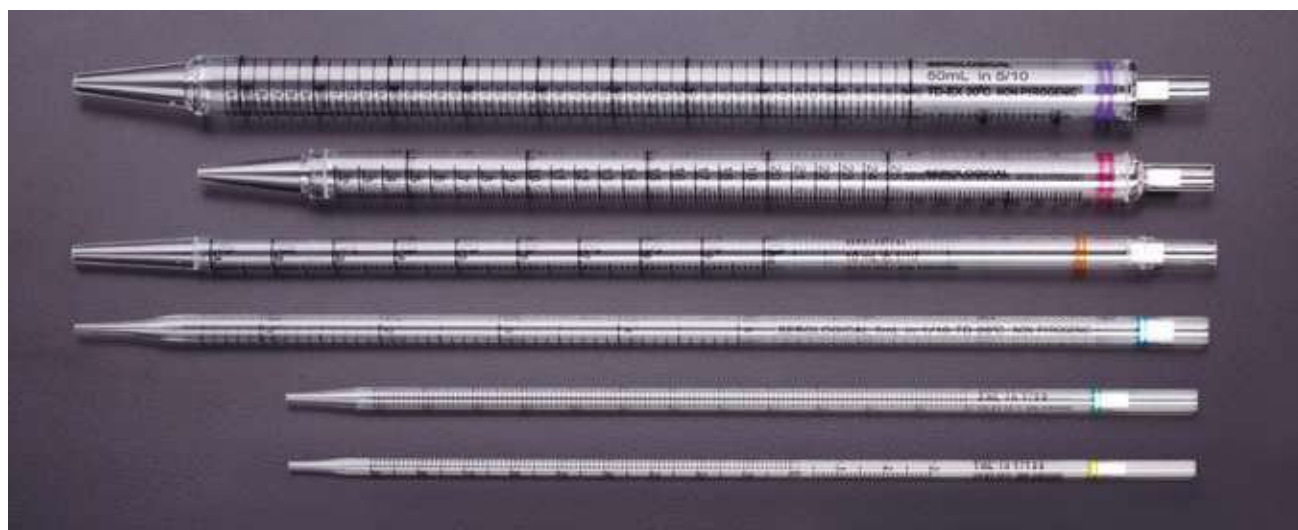

Glass Pasteur pipettes, open mouth

Soda glass. Dimensions: \varnothing mouth: 6.95 ± 0.15 mm; \varnothing tip: 1.2 ± 0.15 mm; 0.53 ± 0.03 thick.

mod	code	total length mm	stem length mm	case quantity	case weight	case volume
1	701	150	59	4 x 250	3.33	0.012
2	702	230	130	4 x 250	3.50	0.018



Glass Pasteur pipettes, closed tip

Made of neutral soda glass, with the tip closed and cotton in the mouth. Easy opening of the closed part by pushing it slightly. Dimensions: mouth: 7.00 mm; tip: 1.4 to 1.6 mm; thickness: 0.50 mm.

mod	code	total length mm	stem length mm	case quantity	case weight	case volume
3	712	230	130	4 x 250	3.68	0.014

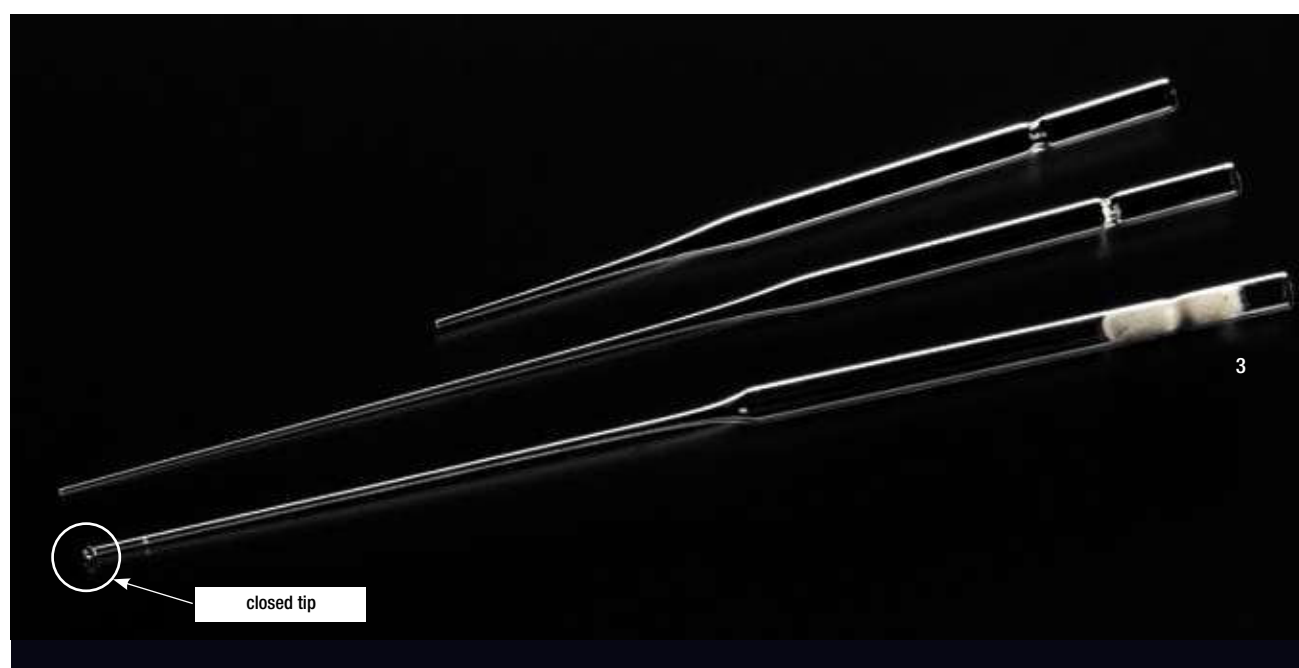



Pipetting bulbs

Designed for pipetting with plastic and glass pipettes.

mod	code	material	total length mm	Ø max. mm	capacity pipetting ml	bag quantity	bag weight	bag volume
1	193914	latex	40	10	3	100	0.22	0.002
2	19195	silicone	40	15	1.5 - 1.8	50	0.22	0.0009

EUROTUBO® Pipetting bulb

This one-handed design is the simplest safety pipette filler to use available. Manufactured in natural orange rubber.

Approx. drawn capacity: 25 ml.

Single hand use, only two operating points. Evacuate via the automatic valve.

Standard model, accommodates all pipettes. Ability to clean inside of bulb by removing patented valve and rinsing out.



code	description	bag quantity	bag weight	bag volume
19200	pipetting bulb	1	0.05	0.0004



1. Evacuate the air by pressing the bulb, as the drawing indicates.



2. Intake by pressing on point B ↻



3. Drain the liquid by pressing on point A ⬇



4. Blow out the pipette by pressing as the drawing indicates (point C).

Pipetting bulb

Made of rubber. Used to avoid mouth pipetting and contamination risk.
Can be opened, cleaned and **autoclaved**.
Ideal for Wintrobe and Westergren pipettes.



code	description	bag quantity	bag weight	bag volume
19201	red pipetting bulb	1	0.04	0.0002



Pipette pumps

Several models for various pipette volumes.
Designed for fast and efficient pipetting with simple, one handed operation.
Pipettes fit smoothly into collar.
Rotate the knurled thumb wheel on the side for precision filling or dispensing,
and press the fast release lever for quick emptying.
Easy to use and easily disassembled for cleaning.
Sizes are colour coded.
Pipette pumps resist acids and alkalis.
Attention: New models coming soon.



code	description	colour	bag quantity	bag weight	bag volume
W-100	up to 2 ml	blue	1	0.06	0.0002
W-110	up to 10 ml	green	1	0.06	0.0002
W-120	up to 25 ml	red	1	0.06	0.0002



See our chapter **Sample storage**



See our chapter **Hygiene and Safety**



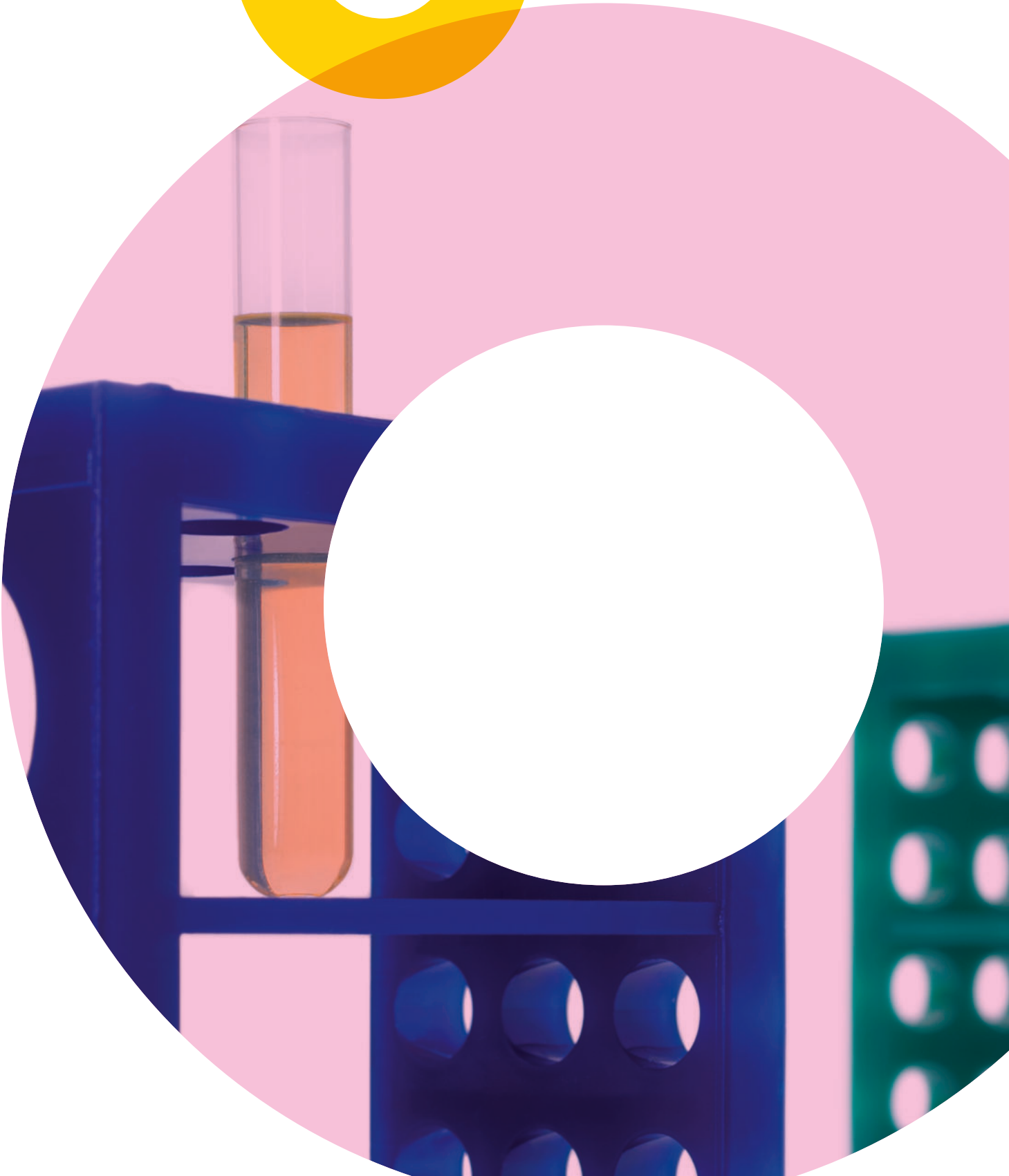

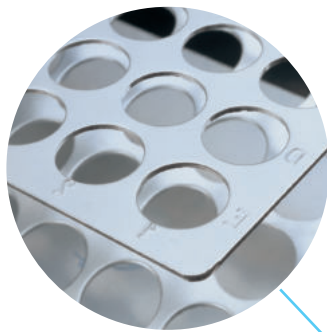

SAMPLE STORAGE



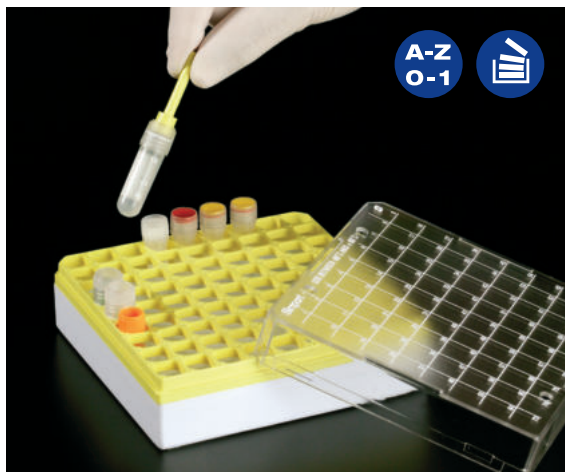

Polystyrene racks for cryovials

Made of **polystyrene**, those boxes are designed to hold 1 and 2 ml cryovials at temperatures from **-80 °C** to **80 °C**. Stackable.

Boxes with white base and numbered inner rack. Boxes are stackable and have air vents.

Covers are keyed to the base to prevent misalignment.

Each box is supplied with an innovate vial picker for easy vial removal.

Dimensions: 133 x 133 x 52 mm. **Capacity:** 81. **Ø wells:** 12.8 mm.

code	colour	capacity	case quantity	case weight	case volume
M-036B		81	4	0.62	0.0045
M-036AM		81	4	0.62	0.0045

Polycarbonate racks for cryovials

These racks provide ultra low temperature storage (from **-196 °C** to **121 °C**), holding 2 or 5 ml cryovials (depending on the model).

Compatible with other storage systems, they can be sterilised using **autoclave** protocols.

They can also be immersed in liquid nitrogen, where its design means minimal issues with excess liquid on their removal.

code	capacity*	model	colour	dimensions mm	diameter mm	max. tubes capacity	max. tubes height	case quantity	case weight	case volume
M-061NA	25	D		75 x 75 x 52	14.44	2 ml	48	5	0.35	0.002
M-061AM	25	E		75 x 75 x 52	14.44	2 ml	48	20	1.40	0.009
M-062B	81	C		132 x 132 x 53	12.7	2 ml	48	5	1.00	0.007
M-062R	81	C		132 x 132 x 53	12.7	2 ml	48	5	1.00	0.007
M-063B	81	B		132 x 132 x 95	12.7	5 ml	93	5	1.25	0.013
M-063R	81	B		132 x 132 x 95	12.7	5 ml	93	5	1.25	0.013
M-064V*	100	A		132 x 132 x 53	12.7	2 ml	48	5	0.95	0.007
M-064AM*	100	A		132 x 132 x 53	12.7	2 ml	48	5	0.95	0.007

*The capacity of codes M-064V and M-064AM is halved when used with capped cryovials with external threads.



Polycarbonate racks for cryovials

Made of extra strong polycarbonate, these boxes are designed to be used at temperatures between **-190 °C** and **121 °C** and are **autoclavables**. Racks can hold either 81 or 100 tubes from 1 ml to 5 ml. They can be immersed in liquid nitrogen. Transparent covers are printed with an alphanumerical grid.

- Boxes made to accept 81 tubes have a white base and a coloured grid (in which each well is numbered) (**A photo**).
- Boxes made to accept 100 tubes* have a coloured base, with each place numbered in the lid, instead of a grid (**B photo**).
- Each box is supplied with an innovative vial picker for easy vial removal (**C photo**).

Boxes are stackable and have air vents. Covers are keyed to the base to prevent misalignment. The racks have boxes of 12x12 mm.

code	colour	case quantity	case weight	case volume
For 1.2 and 2 ml cryovials. Capacity: 81 wells. Dimensions: 133 x 133 x 52 mm				
M-033AM	●	4	0.73	0.0043
M-033R	●	4	0.73	0.0043
M-033V	●	4	0.73	0.0043
For 3.4 and 5 ml cryovials. Capacity: 81 wells. Dimensions: 133 x 133 x 95 mm				
M-034AM	●	10	2.28	0.0200
For 1.2 and 2 ml cryovials. Capacity: 100 wells. Dimensions: 133 x 133 x 52 mm				
M-035AM	●	4	0.72	0.0043
M-035R	●	4	0.72	0.0043
M-035V	●	4	0.72	0.0043

* The capacity of codes M-035AM, M-035R and M-035V, is halved when used with capped cryovials with external threads.

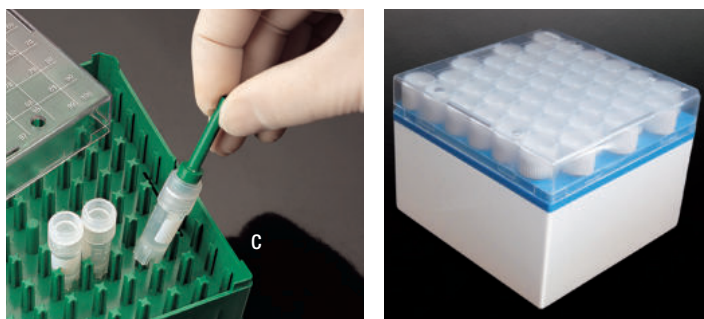

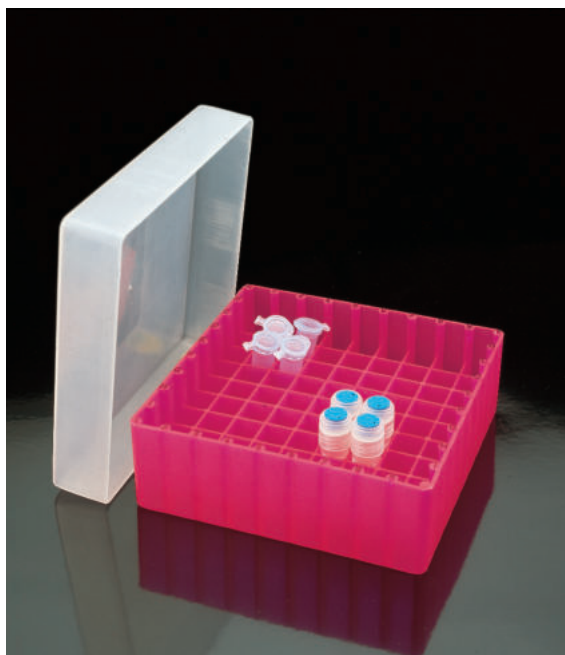

Rack 9x9 height 45

Polypropylene rack. Dimensions with lid: 133 x 133 x 45 mm.
Available in fluorescent colours with transparent lid to help identification.
It resists -100 °C and is autoclavable up to 121 °C.
Sections will hold 81 microtubes (0.5, 1.5 or 2 ml) or cryotubes (1.2 ml) up to 12 mm diameter and 42 mm height.
The capacity is reduced when storing external screw cryotubes.
It embodies an alpha numeric grid printed on the base and over the upper rims for a clearer identification of samples.

Suitable with tubes: **200400, 200401, 200405, 200407, 200410, 4092.2N, 4092.5N, 4092.6N, 4092.6NS, 409001.**



code	colour	quantity	weight	volume
M-020AM	●	1	0.17	0.0003
M-020N	○	1	0.17	0.0003
M-020R	●	1	0.17	0.0003
M-020V	●	1	0.17	0.0003

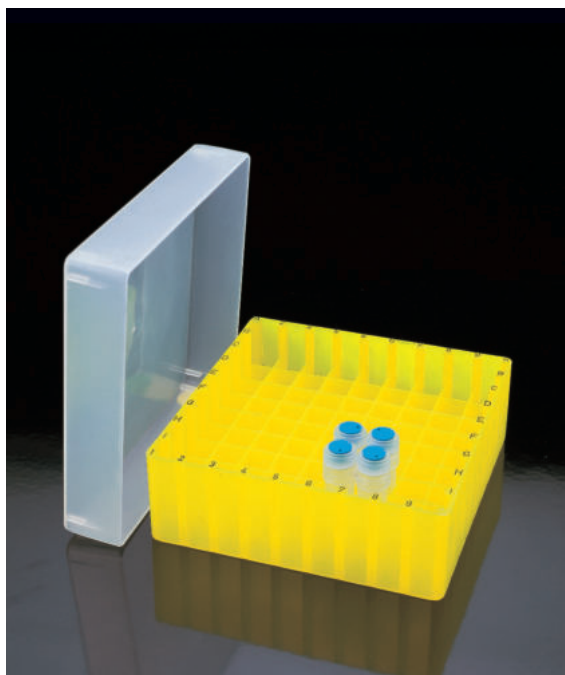

Rack 9x9 height 50

Polypropylene rack. Dimensions with lid: 133 x 133 x 53 mm.
Available in fluorescent colours with transparent lid to help identification.
Resists -100° C and is autoclavable up to 121 °C. Sections will hold 81 microtubes (0.5, 1.5 or 2 ml) or cryotubes (1.2 or 2 ml) up to 12.5 mm diameter and 50 mm height. The capacity is reduced when storing external screw cryotubes. It embodies an alpha numeric grid printed on the base and over the upper rims for a clearer identification of samples.

Suitable with tubes: **200400, 4092.2N, 4092.5N, 4092.6N, 409002, 409002.1, 409110.1, 409111/2.**



code	colour	quantity	weight	volume
U-9950CAM	●	1	0.17	0.0011
U-9950CN	○	1	0.17	0.0011
U-9950CNA	●	1	0.17	0.0011
U-9950CR	●	1	0.17	0.0011
U-9950CV	●	1	0.17	0.0011



Rack 9x9 height 95

Polypropylene rack. It can be frozen down to **-100 °C**, and **autoclaved up to 121 °C**.
Dimensions with lid: 133 x 133 x 95 mm. Available in fluorescent colors with translucent-transparent lid.
Ideal for 4 or 5 ml cryotubes. 81 sections will hold microcontainers up to 12 mm diameter and 93 mm high: screw cap microtubes, cryovials (even those of 4 and 5 ml), snap cap microtubes, and short-medium sized tubes.

Suitable with tubes: **300300, 300500, 300700, 300800, 400700, 400800, 401100.**



code	colour	bag quantity	bag weight	bag volume
U-9581N	○	1	0.24	0.0026

Check availability for yellow and green.

Rack 8x8 round hole height 45

Polypropylene rack, autoclavable up to 121 °C.

Dimensions with lid: 133 x 133 x 53 mm.

Available in fluorescent colours with transparent lid to help identification.

Resists –100° C.

Sections will hold 64 microtubes (0.5, 1.5 or 2 ml) or cryotubes (1.2 ml) up to 11 mm diameter and 42 mm height.

Alphanumeric identification.

Suitable with tubes: 4092.1N, 4092.1NS, 4092.2N, 4092.5N, 4092.6N, 4092.6NS, 200400, 409111/1.



code	colour	quantity	weight	volume
U-8845A	●	1	0.13	0.001

Other colors are supplied upon request. Consult the commercial team.

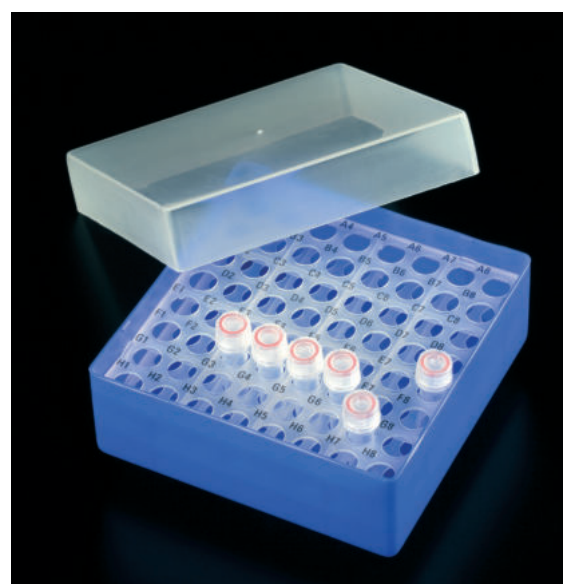

Rack 8x8 round hole height 50

Polypropylene rack, autoclavable up to 121 °C.

Dimensions with lid: 133 x 133 x 53 mm.

Available in fluorescent colours with transparent lid to help identification.

Resists –100° C.

Sections will hold 64 microtubes (0.5, 1.5 or 2 ml) or cryotubes (1.2 or 2 ml) up to 11 mm diameter and 50 mm height.

Alphanumeric identification.

Suitable with tubes: 200400, 408003, 409110.1, 409110.2, 409110.3, 409110.4, 409110.5, 409111/1, 409111/2, 409111/3, 409111/4, 409111/5, 409111/6, 4092.2N, 4092.5N, 4092.6N, 4092.6NS.



code	colour	quantity	weight	volume
U-8850A	●	1	0.13	0.0011

Other colors are supplied upon request. Consult the commercial team.

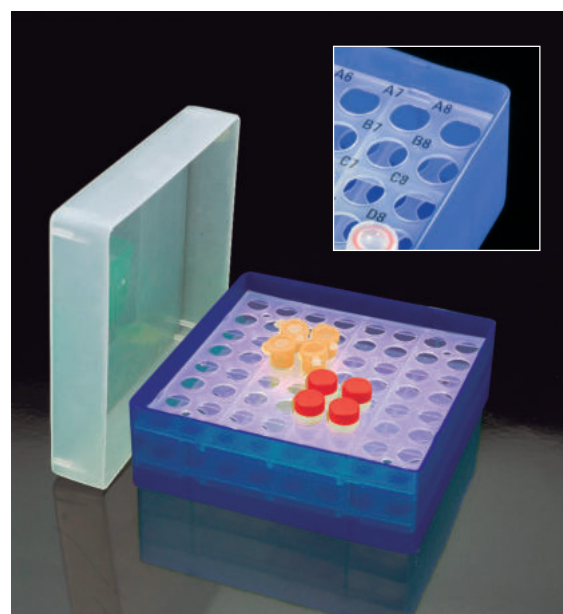

Rack 7x7 height 50

Polypropylene rack, autoclavable up to 121 °C.

Dimensions with lid: 133 x 133 x 53 mm.

Available in fluorescent colours with transparent lid to help identification.

Resists –100° C.

Sections will hold 49 microtubes (0.5, 1.5 or 2 ml), cryotubes (1.2 or 2 ml), or low volume tubes, up to 16 mm diameter and 50 mm height.

Suitable with tubes: 409002, 409002.1, 409104.1, 409106.1, 409106.2.



code	colour	quantity	weight	volume
U-7750A	●	1	0.14	0.0012
U-7750N	○	1	0.14	0.0012

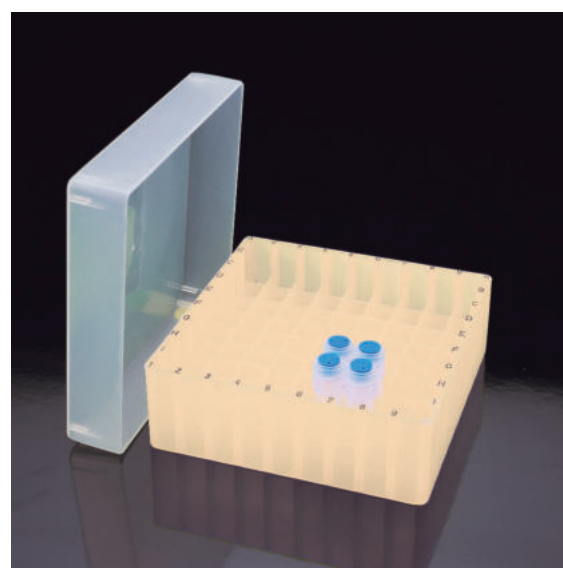



Freezing cardboard storage box, pre-assembled compartments

Designed for storage and preservation of frozen samples.

Made of white treated cardboard and covered by special white paper hand-stuck and hand-assembled for a better quality. Pre-assembled compartments.

Resist temperatures up to -100 °C. Ideal for microtubes and cryovials.

There are alphanumeric identifications printed on each box.

Suitable for the racks of freezer chests.

The models **M-600** and **M-610** are silk screen printed on the base and lid.

The other models have no printings.



code	external dimensions mm	grid num.	Ø holes mm	case quantity	case weight	case volume
M-600	150 x 150 x 55	10 x 10	12	10	1.78	0.023
M-610	150 x 150 x 100	10 x 10	12	10	2.33	0.043
M-607	134 x 134 x 47	10 x 10	10	10	1.23	0.013
M-606	134 x 134 x 57	10 x 10	10	10	1.95	0.013
M-603	134 x 134 x 75	9 x 9	12	10	1.70	0.021
M-604	134 x 134 x 79	9 x 9	12	10	1.75	0.014



Rack 10x10 height 37

Polypropylene rack.

Dimensions with lid: 133 x 133 x 37 mm.

Available in fluorescent colours with transparent lid to help identification.

Resists -196 °C and autoclavable up to 121 °C.

Sections will hold 100 microtubes up to 10 mm diameter and 34 mm height.

Suitable with tubes: **4092.1N, 4092.1NS, 900117.**



code	colour	quantity	weight	volume
U-0537A	●	1	0.15	0.0012
U-0537N	○	1	0.15	0.0012



Rack 4x4 height 45

Polypropylene rack.

Dimensions with lid: 67 x 67 x 45 mm.

Available in fluorescent colors with transparent lid. It can be frozen up to **-196 °C**, and **autoclaved up to 121 °C**.

16 sections (15x15 mm)

It may be used with taller tubes as the lid lies on their caps (up to 60 mm high).

Suitable with tubes: screw cap microtubes (range **409110.1** for example), cryovials (as code **409001**), snap cap microtubes type Eppendorf® (see codes **200400** or **4092.2N**), and short tubes (codes **300500, 400500, 401100**).



code	colour	bag quantity	bag weight	bag volume
U-4445N	○	5	0.17	0.0013
U-4445A	●	5	0.17	0.0013

Racks with lid

Polypropylene rack, **autoclavable** and designed for storage of samples down to **-90 °C**. The lid is jointed to the rack by hinges. Available in fluorescent colours. The racks are alphanumericly matrixed and are designed for 1.5 and 2 ml microtubes or 2.0 ml cryotubes; and we can supply two different models which can accommodate 50 and 100 tubes respectively.

Dimensions: 71 x 153 x 53 mm (50 wells).
140 x 153 x 53 mm (100 wells).



code	colour	Ø holes	holes	case quantity	case weight	case volume
M-500	○	12.50 mm	50	20	2.48	0.020
M-501	●	12.50 mm	50	20	2.48	0.020
M-502	●	12.50 mm	50	20	2.48	0.020
M-503	●	12.50 mm	50	20	2.48	0.020
M-510	○	12.45 mm	100	20	3.98	0.028
M-511	●	12.45 mm	100	20	3.98	0.028
M-512	●	12.45 mm	100	20	3.98	0.028
M-513	●	12.45 mm	100	20	3.98	0.028

Minimum order quantity: 5 and multiples of 5 up to 20. From 20, multiples of 20.



Microtube racks with lift-off telescopic lid

Made of **autoclavable polypropylene**, those racks are designed for long-term storage of samples at temperatures down to **-90 °C**.

Model **M-450** can accommodate 50 microtubes of 0.5 ml (hole diameter 10 mm).

Model **M-410** can accommodate 50 microtubes of 1.5/2.0 ml (hole diameter 12 mm).

Lids have a moulded-in alphanumeric location identification system with a clear centre panel for easy tube viewing. Four frosted side panels and a frosted rim on the edges of the lid provide additional labeling options.



code	dimensions mm	case quantity	case weight	case volume
M-450	120 x 60. height 37.5	5	0.48	0.0022
M-410	140 x 73. height 37.5	5	0.53	0.0035



Microtube storage racks in hinged boxes

Made of white **polypropylene**. Designed to hold 24 or 48 microtubes or cryovials of 1.5/2.0 ml sizes. Tubes are presented on four levels for better sample viewing. Each well is numbered.

Model M-052 consists of one 24 hole-rack supplied in a white hinged box with transparent cover; model **M-053** consists of two 24-hole racks, also housed in a white hinged box with transparent cover. Racks are removable from boxes and are stackable.

They float in water bath and can incorporate dry ice for use with frozen samples on the bench.

Fully autoclavable (**121 °C**) and freezable down to **-90 °C**.

Dimensions: **M-052:** 120 x 85 x 60 mm.

M-053: 235 x 85 x 60 mm.

Ø holes: 12.15 mm



code	dimensions mm	case quantity	case weight	case volume
M-052	rack for 24 microtubes	10	1.34	0.009
M-053	rack for 48 microtubes	5	1.34	0.009



Reversible racks with removable handles

Made of polypropylene, **autoclavable up to 121 °C**.

Dimensions: 223 x 67 x 27mm

The racks have two sides for different tubes: one side holds up to 80 tubes of 12 mm diameter (for example 10 x 75 mm or 12 x 75 mm tubes, microtubes, etc.) and the other side holds up to 60 microtubes or PCR tubes (8 mm Ø, 0.2 or 0.5 ml).

By removing the handles, units can be firmly anchored laterally to one another and more units can be added on top of each other, thanks to small pins supplied with the racks.

code	colour	bag quantity	bag weight	bag volume
M-563A		10	1.60	0.008
M-563NA		10	1.60	0.008



80 well racks

Made of **autoclavable polypropylene**, those racks are designed for freezer storage and are rated to **-80 °C**.

Racks are designed to accommodate microtubes of diameter up to 11 mm. They are space-saving, as they feature 80 wells in a 5 x 16 configuration. An alpha-numeric matrix allows accurate sample identification.

Lateral handles allow easy handling of the racks. Racks can be used alone or placed into the box **M-011.1** (made of translucent plastic).

Racks are compatible with the Gilson FC80 dispenser, for example.

code	colour	dimensions mm	case quantity	case weight	case volume
M-010.1		225 x 65 x 27	5	0.86	0.0023
M-010.2		225 x 65 x 27	5	0.86	0.0023
M-010.5		225 x 65 x 27	5	0.86	0.0023
M-010.6		225 x 65 x 27	5	0.86	0.0023
M-010.7		225 x 65 x 27	5	0.86	0.0023
M-011.1	box with lid	230 x 85 x 60	5	0.65	0.0070



Isofreeze Rack with temperature indicator

Manufactured from **polypropylene**, this rack is filled with a non-toxic gel that maintains **4 °C** temperature for almost three hours and a half when the rack is removed from the freezer (or in case of freezer failure), protecting PCR reagents, cells, enzymes, etc. from fast temperature changes.

Moreover, the plastic changes its colour from green to yellow as long as the temperature of the rack changes (see figure). It can hold up to 96 0,2 ml single microtubes, strips, and plates.

Dimensions with lid: 141 x 99 x 44 mm.

Dimensions without lid: 141 x 99 x 38 mm.

ATTENTION: Freeze for a minimum of eight hours at **-20 °C** before use. Keep it covered while being used. Store at the freezer while not being used.

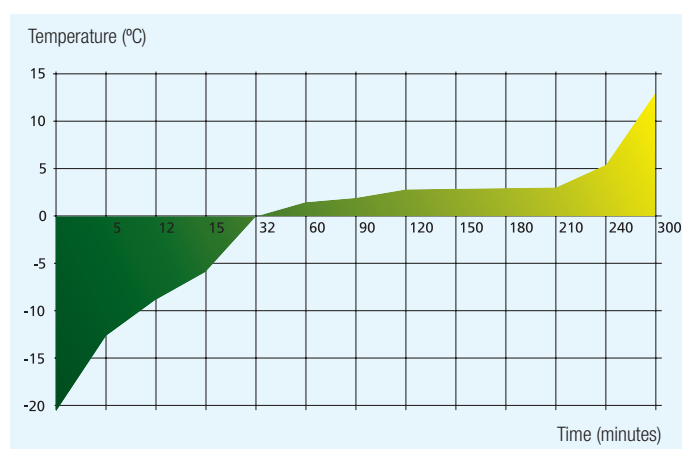

See our PCR tubes and plates in chapter **Cell culture, Molecular biology**



code	Ø holes mm	case quantity	case weight	case volume
M-572	6,78	2	0.64	0.003

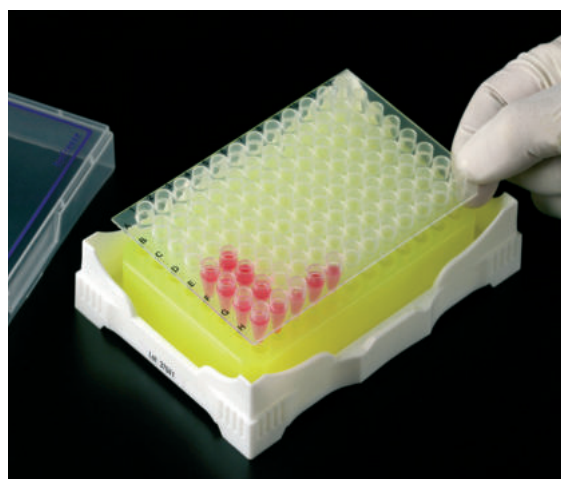

Rack at room temperature

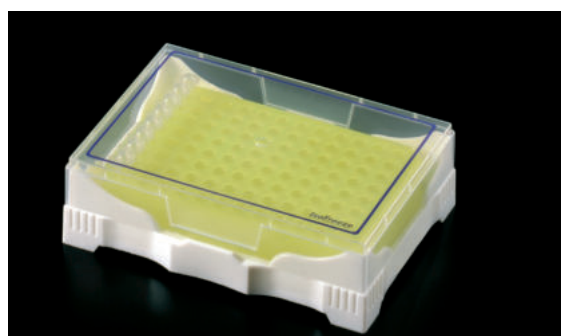

Rack at -20 °C



96 well PCR rack

Base and cover made of **autoclavable polypropylene**.

Designed for storing and working 0,2 ml PCR tubes, separate or in strips. 96-well plates can also be accommodated. Both base and cover have an alphanumeric identification.

Once covered they are stackable.

Racks can be horizontally attached to each other in order to build-up any configuration.

Dimensions with cover: 132 x 91 x 32 mm

It withstands from **-90 °C** to **121 °C**.

The wells are conical with **diameters** of 6mm and 4mm.



code	colour	case quantity	case weight	case volume
M-585	●	20	3.00	0.020
M-581	●	20	3.00	0.020

Minimum order quantity: 5 and multiples of 5 up to 20.





24 well incubation rack

Made of **autoclavable polypropylene**.

This floating rack will incubate up to 24 microtubes in a water bath and can accommodate either 0.5 ml or 1.5 ml tubes.

Tubes are held snugly and then released when the rack is pressed down on a benchtop.

The rack is alphanumerically labelled for better sample identification.

Dimensions: 119 x 78 mm.



code	description	case quantity	case weight	case volume
M-022	incubation rack	4	0.29	0.0024



Round incubation racks

Made of **autoclavable polypropylene**, those racks are designed to hold either 8 or 20 microtubes (1.5 ml) in 10.8 mm holes.

Even when the rack is fully loaded, tubes are completely immersed while tops rest above the rack, floating in a beaker of water.

Perfect for use in benchtop incubation.

The rack is easily unloaded by lightly pressing it down against the bench until the legs touch, releasing the tubes.

Racks are 6.4 mm thick with 19 mm long legs and a central handle.



code	capacity	Ø rack	case quantity	case weight	case volume
M-024	8 tubes	66	4	0.13	0.0015
M-026	20 tubes	105	4	0.20	0.0075



IsoFreeze reversible racks with lid

Manufactured from virtually unbreakable **polycarbonate** and filled with a non-toxic gel, those Isofreeze temperature maintenance racks provide consistent thermal protection for PCR reagents, cells, enzymes or other temperature sensitive agents when removed from the freezer or refrigerator for extended periods of time, and provide safe storage on the event of freezer failure.

Each rack can accommodate up to 20 1.5/2.0 ml microtubes on one side (Ø holes: 12.1 mm), or 20 0.5 ml microtubes (Ø holes: 8.33 mm) on the reverse side.

Racks feature a transparent lid for better sample viewing. Each well in the rack is numbered. Available in two temperature ranges.

Model M-570 (white) will maintain a temperature of 0 °C on the bench top for 5 hours.

Model M-571 (blue) will maintain a temperature between -10 °C and -20 °C on the bench top up to 3 hours.

Dimensions with lid: 172 x 180 x 70 mm.



code	colour	case quantity	case weight	case volume
M-570	○	1	1.30	0.005
M-571	●	1	1.30	0.005

20 well interlocking tube racks

Made of blue **autoclavable polypropylene**.

These racks slide together on both sides to allow the user to attach several for larger experiments.

They are designed to accommodate 1.5/2.0 ml Eppendorf® type tubes on two levels of 10 wells each of 10 mm Ø, with easy-to-read numbers for better tube viewing and identification.

The innovative front finger slot makes them easy to handle when working with gloves. **Dimensions:** 210 x 90 x 48 mm.



code	colour	case quantity	case weight	case volume
200420	●	6	0.80	0.004

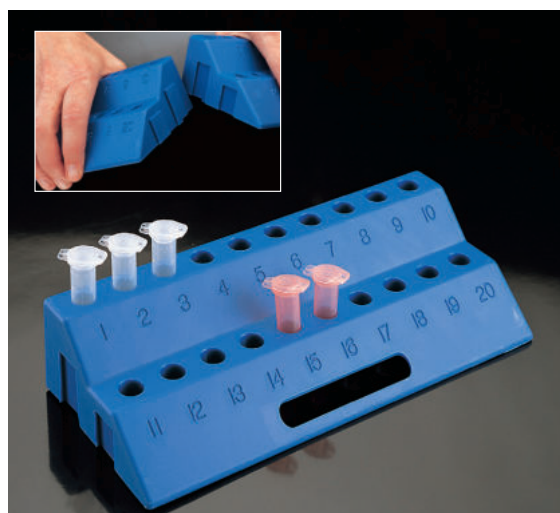

50 well microtube racks

Made of **autoclavable polypropylene**, these racks are designed for use with the tubes presented on page 166 and successive. They can hold 50 tubes in a 10 x 5 configuration. These racks allow easy one handed opening and closing of tubes thanks to an innovative locking system which ensures that tubes will securely lock in each well and will not turn. Each place is identified with an alphanumeric index for better sample location. Racks have strong handles for better handling and are stackable.

Dimensions: 100 x 250 x 25 mm. **Diameter:** 12 mm

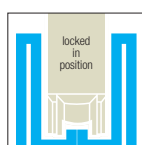

code	colour	case quantity	case weight	case volume
M-028.5	●	4	1.00	0.004
M-028.6	●	4	1.00	0.004

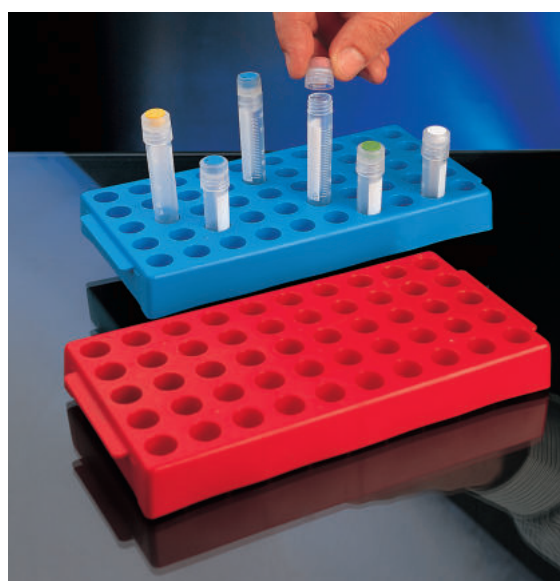

Styrofoam racks with lid

Racks made of expandable **polystyrene**.

Ideal for long term storage of microtubes in the freezer.

These racks have alphanumeric graduation for a proper identification of the tubes. They are stackable, lightweight and economical.

Diameter: 11,5 mm



code	description	suitables microtubes	dimensions (mm)	case quantity	case weight	case volume
G-050	50 wells rack	1.5 – 2 ml	210 x 107 x 65	10	0.49	0.017
G-100	100 wells rack	1.5 – 2 ml	335 x 95 x 68	10	0.57	0.056

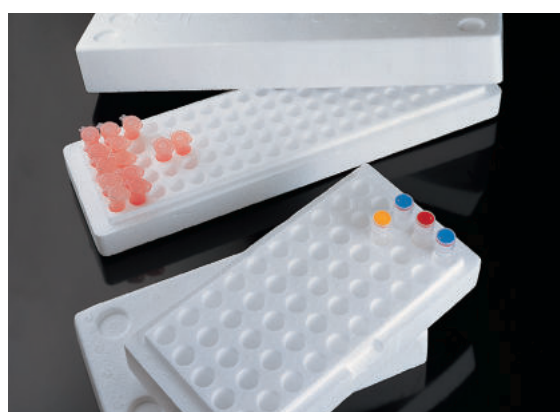

Styrofoam racks without lid

Racks made of expandable **polystyrene**.

Ideal for long term storage of microtubes in the freezer.

They are stackable, lightweight and economical.

100 wells rack.



code	suitables microtubes	dimensions (mm)	Ø holes	case quantity	case weight	case volume
244109	10 ml	224 x 213 x 48	16 mm	24	1.40	0.069
244111	5 ml	194 x 183 x 43	13 mm	48	1.90	0.094

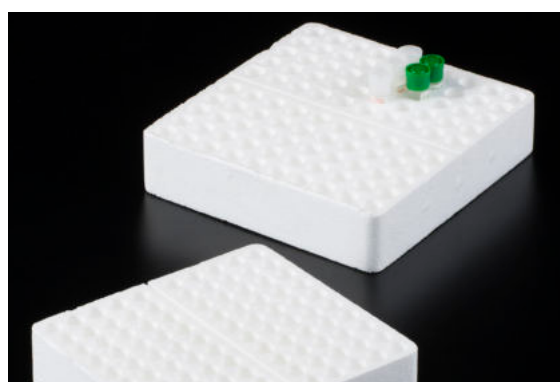

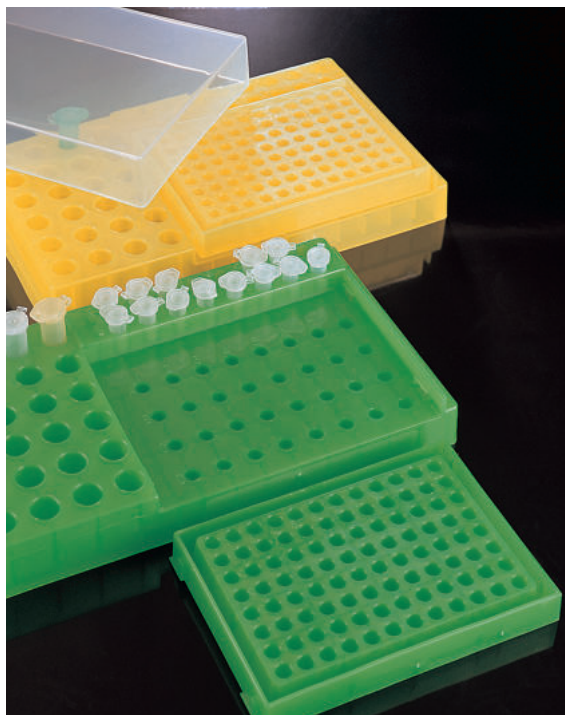

PCR workstations

Autoclavable manufactured in polypropylene. This storage/working rack, with lid, is designed to work with different PCR volumes at the same time. It can accommodate up to 32 individual 0.2 ml PCR tubes (Ø: 6,35 mm), 16 0.5 ml microtubes (Ø: 8,20 mm) and 24 1.5/2.0 ml (Ø: 11,43 mm). Tube wells are alpha-numerically matrixed with raised bold type for accurate sample identification. The rack also has a transparent lid for easy viewing of samples. Frosted writing panels on four sides allow labelling or writing. The rack is supplied with a removable rack accommodating 0.2 ml PCR tubes. The removable rack can be purchased separately; see product code below.

Dimensions: main rack: 215 x 118 x 50 mm.

Removable rack: 125 x 85 x 15 mm.

Both racks withstands from **-90 °C to 121 °C**.



code	colour	case quantity	case weight	case volume
M-540	●	5	1.46	0.007
M-541	●	5	1.46	0.007
M-542	●	5	1.46	0.007

Minimum unit sale: 5

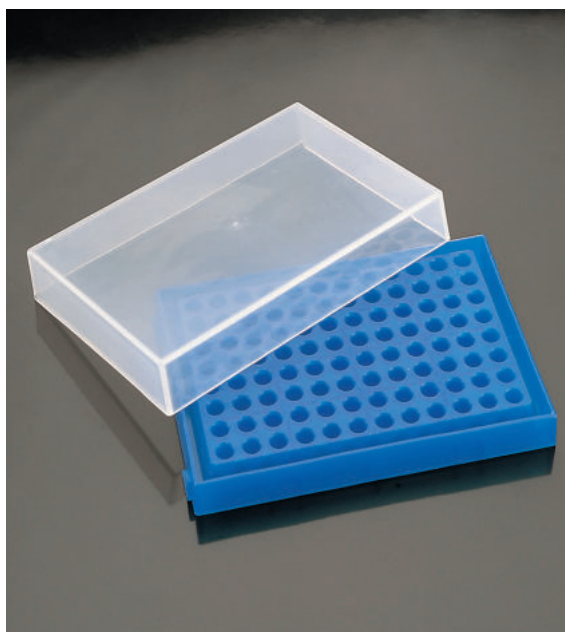

96 well PCR racks

Autoclavable polypropylene.

Our 96 well plate, individual tubes or strips of 8 or 12 tubes can be used with this rack. An alphanumeric grid helps sample identification.

The included lid is transparent and has a non-slip surface to allow safe storage of multiple racks.

This rack can be used alone or inserted in the above workstation, code **M-540**.

Dimensions: 125 x 85 x 15 mm. It withstands from **-90 °C to 121 °C**.

Ø: 6.10 mm.



code	colour	case quantity	case weight	case volume
M-550	●	5	0.80	0.005
M-551	●	5	0.80	0.005
M-552	●	5	0.80	0.005
M-553	●	5	0.80	0.005



5ml microtubes rack

Supports common tube sizes (0.5, 1.5 / 2.0 and 5.0 ml).

Ideal for microtubes and microcentrifuge tubes.

The lateral notches facilitate easy removal of the lid.

Suitable for temperatures as low as -90 °C, as well as autoclaving.

The racks come with a lid.

Dimensions: 143.8 x 75.2 x 53.0 mm.



code	colour	case quantity	case weight	case volume
M-015	○	5	2.30	0,013

Stacking PCR work up rack

Autoclavable polypropylene. The stacking PCR work-up rack is a robust and convenient workstation or storage rack for plates, strips or tubes.

Dimensiones with lid: 98 x 138 x 39 mm.

Dimensiones without lid: 98 x 138 x 30 mm.

It withstands from **-90 °C** to **121 °C**. The conveniently small footprint ensures it is an equally useful tool whether it is used on the bench, in the freezer or some other laboratory situation. The positive click ensures the lid will not become easily dislodged. Yet only a gentle squeeze on each side will allow you to lift off the clear lid. It accommodates every different type of 0,2 ml PCR plate; including fully skirted types, strips or tubes. The imaginative shaping of the rack's feet make this system easy to use, providing a stable platform as well as enabling **stacking with or without the lid** and whether the vessels are open or sealed.

The racks are manufactured in distinctive colours and are packaged as an assortment.



code	description	case quantity	case weight	case volume
M-554	stacking PCR rack	5	0.45	0.0035

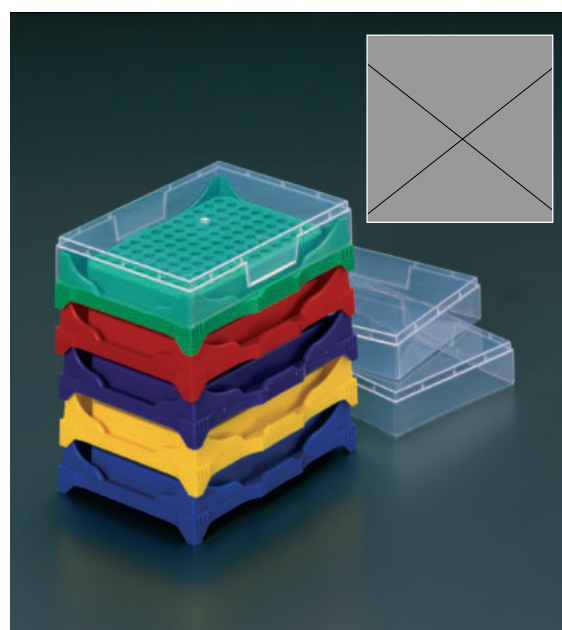

COMBI Rack for PCR tubes

The box is made of (**non autoclavable**) PVC and the rack is made of **autoclavable** polypropylene. Rack and box can be used both together and separately.

The box: can be used not only as a storage rack but also as a work station. The white base accepts both 96 and 384 well plates and a transparent cover.

It is stackable, and its low height helps to save space. Lid dimensions: 108.0 x 148.6 x 35.6 mm. Box dimensions: 108.0 x 148.6 x 24.9 mm.

The rack: can hold up to 96 PCR tubes or plates or 12 strips of 8 tubes with caps.

Each hole is identified with an alpha numeric numbering system.

It features a writing area. The grid stands on 4 legs and can be placed on a lab counter or in a refrigerator. It is stackable.

Can withstand temperatures from **-80 °C** to **121 °C**.

Dimensions: 84.6 x 125.5 x 28.9 mm.



code	description	case quantity	case weight	case volume
M-640	white box with lid	5	0.20	0.0004
M-641	96 hole blue rack	5	0.20	0.0004

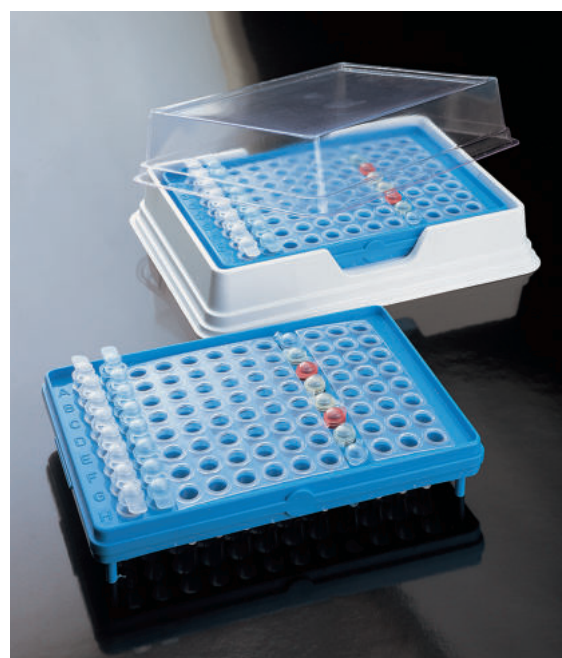

Reversible 96 well racks with lid

Made of durable **autoclavable** polypropylene. This reversible rack with a clear polypropylene lid is designed with wide spacing to store up to 96 microtubes on either side. One side accommodates 1.5/2.0 ml microtubes; the reverse side accommodates 0.5 ml microtubes. The rack is alphanumericly matrixed for better sample location and has frosted writing patches on all four sides for smear resistant labelling. Operating temperature range: **-90 °C** to **121 °C**.

With ergonomical lateral handles.

Dimensions: 213x114x26 mm.

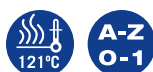

code	colour	case quantity	case weight	case volume
M-021AM	●	5	2.05	0.008
M-021R	●	5	2.05	0.008
M-021V	●	5	2.05	0.008

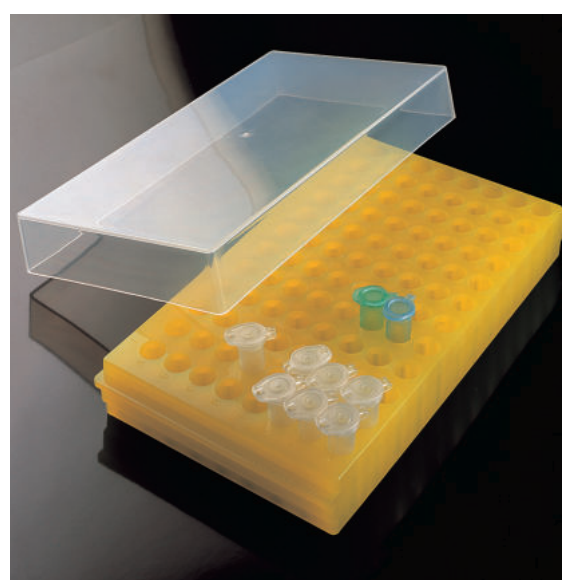

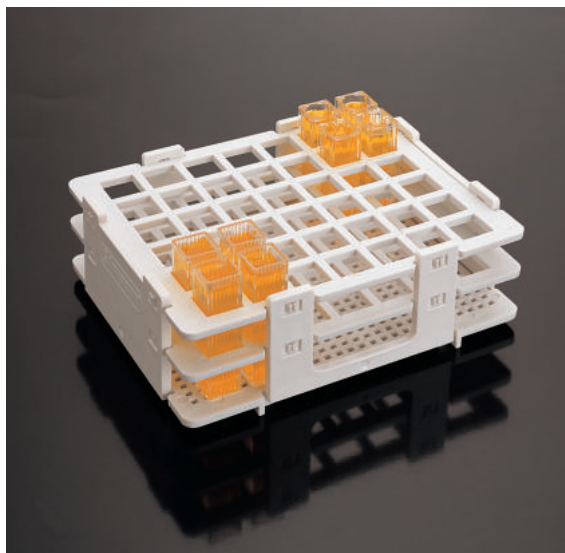

42 well cuvette rack

Made of white **autoclavable** polypropylene, this easy to assemble rack provides gentle no-scratch support for fragile spectrophotometer cells.

Forty-two 12 mm light path cells fit in this 6 x 7 row layout (See page 81).

Also suitable for tubes.

Racks are supplied dismantled.

Dimensions: 128 x 105 x 43 mm. **Holes:** 12x12mm



code	description	case quantity	case weight	case volume
M-100	well cuvette rack	8	1.04	0.013

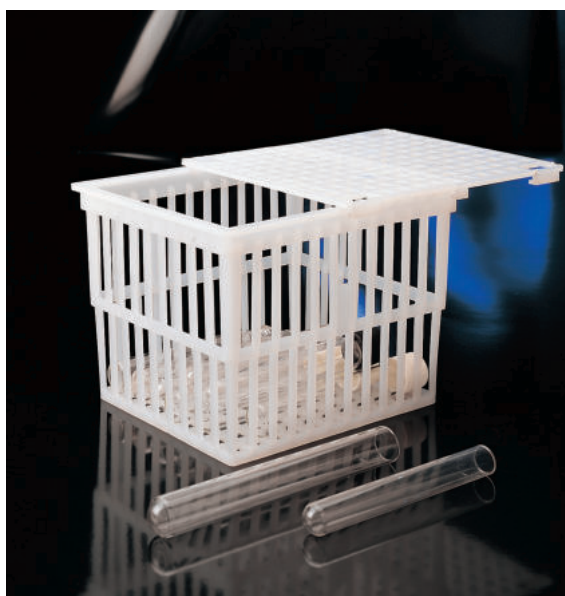

Test tube baskets

For rinsing, transport and storage.

Made of **autoclavable** polypropylene, these baskets with sliding lids are ideal for rinsing or carrying glassware.



code	description	case quantity	case weight	case volume
M-050	basket 152 x 152 x 152 mm	6	1.39	0.003
M-060	basket 229 x 229 x 229 mm	6	3.12	0.080



Pipette rack

Made of **autoclavable** polypropylene.

For orderly, space-saving pipette storage.

This rack holds 50 pipettes in a vertical 5 x 10 arrangement.

This system ensures that pipettes will not contact table surface.

The end plates have handles for easy carrying.

Hole diameter: 16 mm.

Dimensions: 213 x 114 x 222 mm.



code	description	case quantity	case weight	case volume
19973	pipette rack	1	0.54	0.006

Universal racks

Made of durable polypropylene, this versatile rack is specially **designed to attach to another by pressing the two sides together**. Two racks or more can then be attached to present tubes in varied configurations.

The rack can accommodate the following:

- 4 x 50 ml conical tubes
- 12 x 15 ml conical tubes
- 32 x Ø12 mm tubes or 1.5/2.0 ml microtubes
- 32 x 0.5 ml microtubes

Alpha-numeric matrix on the four sides for better sample location. Can be autoclaved and can be placed in freezers and water baths.

Dimensions: 172 x 50 x 90 mm.



code	colour	case quantity	case weight	case volume
M-520	○	5	0.96	0.005
M-521	●	5	0.96	0.005
M-522	●	5	0.96	0.005
M-523	●	5	0.96	0.005

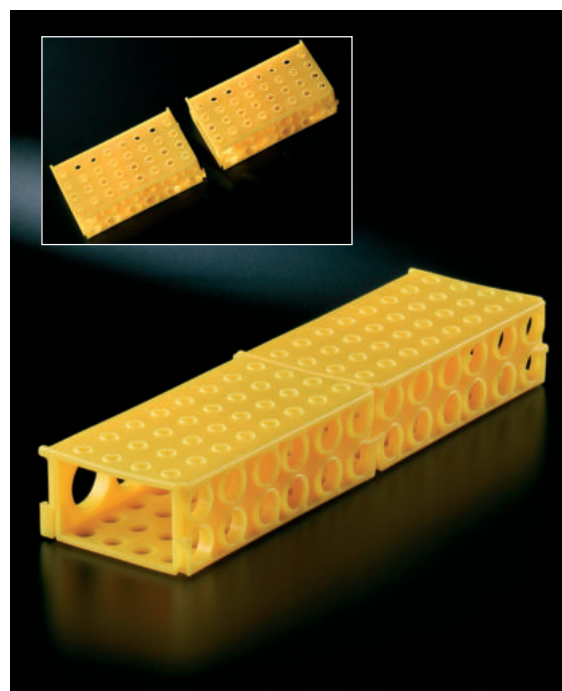

Universal racks

Made of **autoclavable** polypropylene, it withstands from **-90 °C to 121 °C**.

This tube rack system is designed to support a variety of tube sizes and styles:

- Ø 30 mm for 8 x 50 ml tubes
- Ø 20 mm for 20 tubes
- Ø 16/17 mm for 24 x 15 ml tubes
- Ø 12/13 mm for 40 tubes

Dimensions: 198 x 118 x 96 mm.



code	colour	case quantity	case weight	case volume
M-530	●	5	1.93	0.015

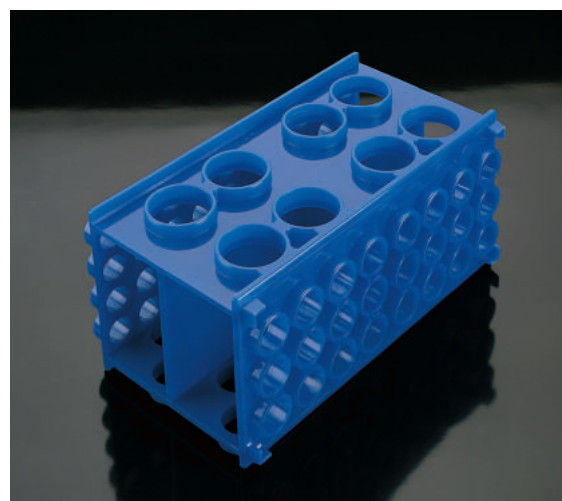

Set of mixed Combi rack

Made of **autoclavable** polypropylene.

It withstands from **-90 °C to 121 °C**.

This design consists of a unit of four independent cubes packaged in a clear support tray.

Each rack may be independently rotated to allow the simultaneous storage and use of multiple sizes of tubes.

Each side of the racks is alpha-numeric matrixed for better sample location.

The following tubes can be accommodated in each rack:

- 2 x 50 ml conical tubes
- 6 x 15 ml conical tubes
- 9 x 12 mm diameter tubes or 1.5/2.0 ml microtubes
- 12 x 0.5 ml microtubes

Dimensions:

Tray (handles included): 242 x 120 x 40 mm.

Rack: 48 x 92 x 92 mm.



code	colour	case quantity	case weight	case volume
330	● ● ● ●	1	0.63	0.003



Universal test tube racks

Round hole test tube racks made of white **autoclavable** polypropylene.

A side panel provides a labelling option. Very easy to assemble.

Racks are supplied dismantled.

Dimensions: 240 x 103 x 65 mm.

code	max. diameter tubes	tube capacity	bag quantity	bag weight	bag volume
W-014	13	6 x 15 (90)	1	0.19	0.012
W-015	16	5 x 12 (60)	1	0.20	0.012
W-017	25	3 x 8 (24)	1	0.19	0.010
W-018	30	3 x 7 (21)	1	0.16	0.008

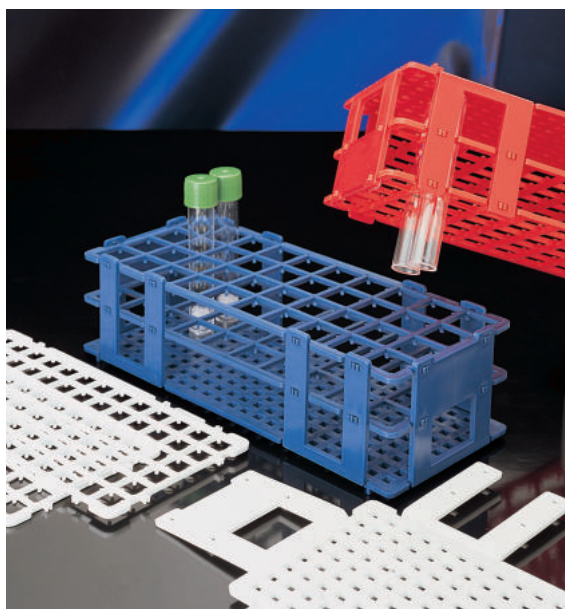
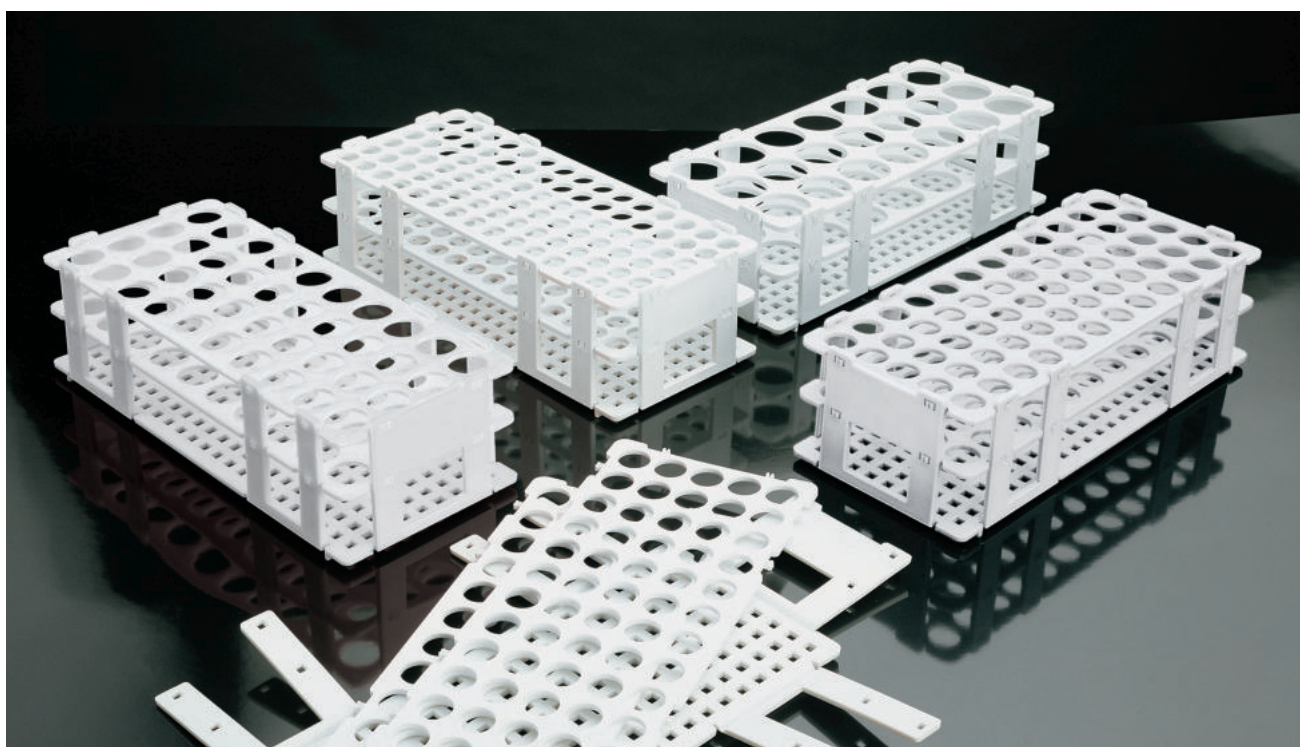

Square hole test tube racks with grip

These high quality polypropylene racks are **autoclavable**, stackable when unloaded and can be dismantled for space saving.

A unique grip feature ensures that tubes are firmly held in racks. An alphanumeric grid reference ensures an easy sample location.

Dimensions: 250 x 105 x 68 mm.

Very easy to assemble.

Racks are supplied dismantled.



code	max. diameter tubes mm	colour	tube capacity	bag quantity	bag weight	bag volume
W-011	13	○	6 x 15 (90)	1	0.18	0.0012
W-012	16	○	5 x 12 (60)	1	0.18	0.0013

Universal test tube racks

Made of white **autoclavable** polypropylene. Specially designed to ensure that all test tubes will be incubated at the same temperature. An alpha-numeric grid reference on top tier of the rack allows an easy sample location. Racks are easily assembled, and are stackable when unloaded. Each rack is supplied dismantled. Easy to assemble.

code	places	Ø test tube mm	dimensions mm	bag quantity	bag weight	bag volume	blue	yellow	red
							(to add at the end of the code)		
19563	100 (4 x 25)	micro	262 x 108 x 45	5	0.70	0.007	.04	.06	.10
19564	90 (6 x 15)	13	246.5 x 104 x 60	5	0.80	0.006	.04	.06	.10
19565	60 (5 x 12)	16	246.5 x 104 x 70	5	0.89	0.006	.04	.06	.10
19566	40 (4 x 10)	20	246.5 x 104 x 70	5	0.82	0.006	.04	.06	.10
19567	40 (4 x 10)	25	296.5 x 124 x 85	5	1.00	0.007	.04	.06	.10
19568	24 (3 x 8)	30	300 x 111 x 83	5	0.88	0.009	.04	.06	.10



Assembling rack

This rack is moulded of blue **autoclavable** polypropylene. Suitable for daily usage and storage. It holds up to 21 tubes of 50 ml (30 mm diameter) each, and features end plates for labelling, as well as numbered and lettered rows for tube identification. Interlocking feet allows stacking of racks for storage.

This rack is supplied flat, individually bagged. Fast and easy assembling (instructions included).



code	dimensions mm	rows	case quantity	case weight	case volume
19570	246 x 104 x 64	3 x 7	8	1.50	0.020





Acetal polymer racks

Made of acetal polymer. **Autoclavable up to 121 °C** for 20 minutes. Stackable. Compact and lightweight. They remains stable if submerged. Color blue. With handles on each side for better handling. External dimensions for all codes: 293 mm x 115 mm x 65 mm H.

Recommended for tubes: 12 x 75, 15 x 95, 16 x 100, centrifugation tubes, urine collection tubes, etc.



code	for tubes Ø	capacity	case quantity	case weight	case volume
M-560A	up to 13 mm	(6 x 14) 84	10	3.27	0.032
M-561A	up to 16 mm	(5 x 12) 60	10	3.00	0.029

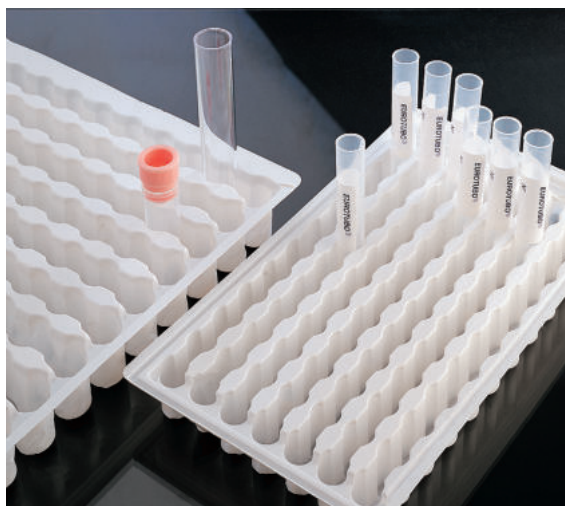

Single use racks

Low-price, flexible racks made of polystyrene. Dimensions:

901407: 200 x 240 x 30 mm

901410: 160 x 170 x 25 mm

code	Ø hole	n° holes	case quantity	case weight	case volume
901407	16 mm	10 x 12	25	1.90	0.033
901410	13 mm	10 x 10	25	0.66	0.012

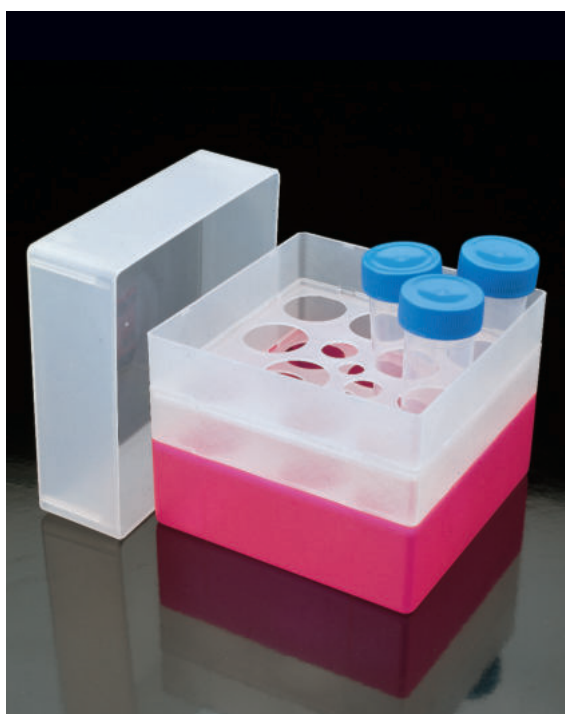

Combi rack height 128

Polypropylene rack. Dimensions with lid: 133 x 133 x 128 mm. Available in fluorescent colours with transparent lid to help identification. Resist **-196 °C** and autoclavable up to **121 °C**. Sections will hold 10 tubes up to 30 mm diameter, 2 tubes up to 16 mm Ø and 1 tube up to 11 mm Ø. All of them up to 125 mm height.

Suitable with tubes: 10100T, 300400, 300705, 300707, 300900, 300907, 300908, 301200, 301201, 301202, 301212, 301213, 301403, 301700, 400400, 400705, 400900, 401200, 401201, 401204, 401403, 401700, 409920, 429900, 429901, 429910, 429926, 429927, 429930, 429931, 713100, 716100, 716125, 720125, 901075, 913100, 916100.



code	colour	bag quantity	bag weight	bag volume
U-50128A	●	1	0.20	0.0035
U-50128R	●	1	0.20	0.0035
U-50128V	●	1	0.20	0.0035

Rack 1x1 height 45

Polypropylene rack.
 Dimensions with lid: 133 x 133 x 45 mm.
 Available in fluorescent colours with transparent lid to help identification.
Resists -196 °C and autoclavable up to 121 °C.
 Only 1 cavity.

Suitable for all kind of tubes and other objects.



code	colour	quantity	weight	volume
U-1145A	●	1	0.10	0.0012
U-1145N	○	1	0.10	0.0012

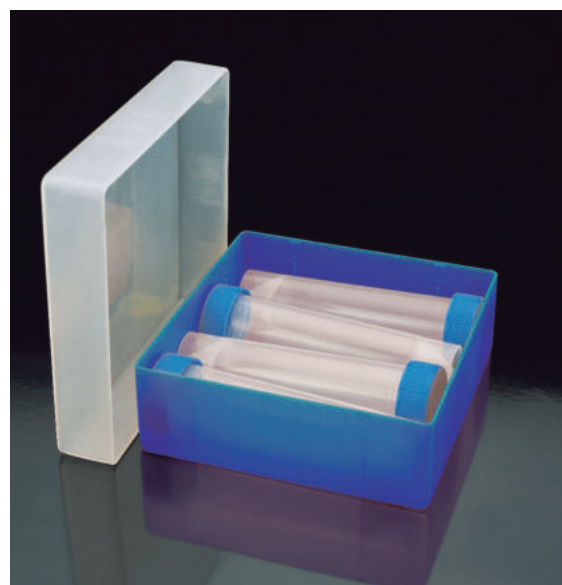

Rack 1x1 height 70

Polypropylene rack.
 Dimensions with lid: 133 x 133 x 70 mm.
 Available in fluorescent colours with transparent lid to help identification.
Resists -196 °C and autoclavable up to 121 °C.

Only one cavity. Suitable for all kind of tubes and other objects.



code	colour	quantity	weight	volume
U-1170A	●	1	0.12	0.0014
U-1170N	○	1	0.12	0.0014

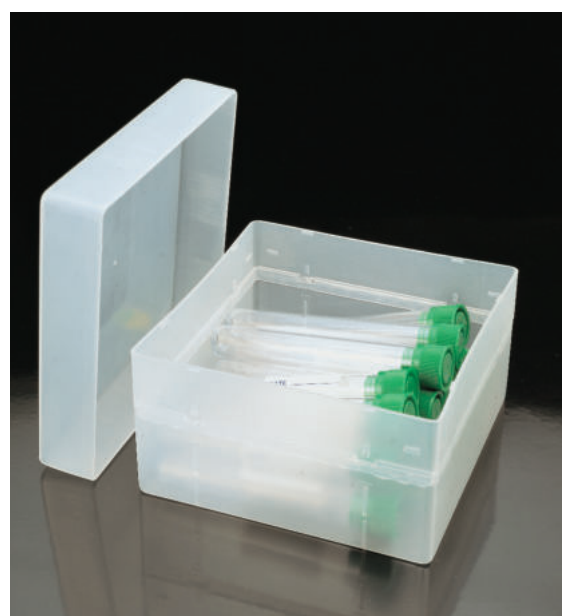

Rack 9x9 height 70

Polypropylene rack.
 Dimensions with lid: 133 x 133 x 70 mm.
 Available in fluorescent colours with transparent lid to help identification.
Resists -196 °C and autoclavable up to 121 °C.
 Sections will hold 81 tubes up to 12 mm diameter and 67 mm height.

Ideal for our references 300500 and 400500, etc.



code	colour	quantity	weight	volume
U-9970A	●	1	0.18	0.0014

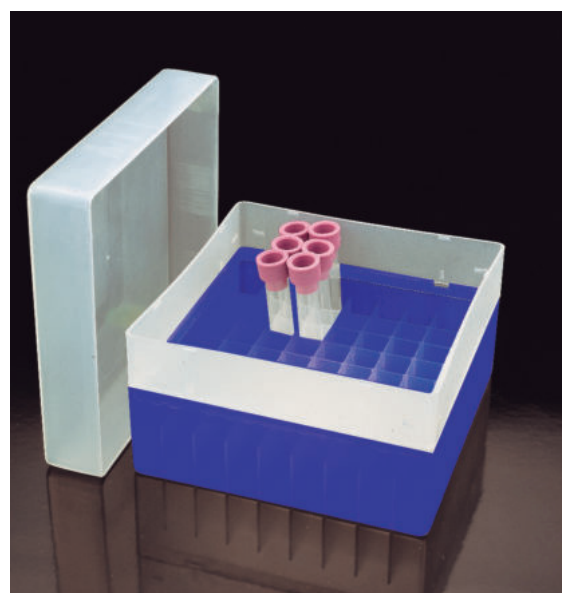



Rack 7x7 height 80

Polypropylene rack.

Dimensions with lid: 133 x 133 x 80 mm.

Available in fluorescent colours with transparent lid to help identification.

Resists **-196 °C** and **autoclavable** up to **121 °C**.

Sections will hold 49 tubes up to 16 mm diameter and 77 mm height.

Suitable with tubes: **401100, 409003.1, 409107.1, 409108.1.**



code	colour	quantity	weight	volume
U-7780A	●	1	0.16	0.0016
U-7780N	○	1	0.16	0.0016
U-7780NA	●	1	0.16	0.0016

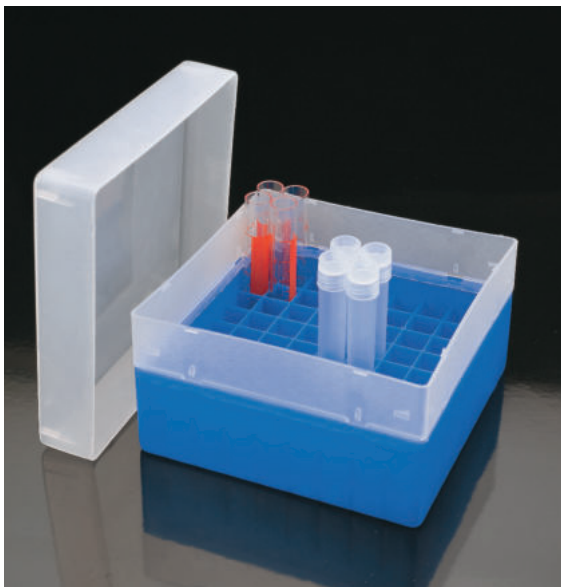

Rack 9x9 height 80

Polypropylene rack.

Dimensions with lid: 133 x 133 x 80 mm.

Available in fluorescent colours with transparent lid to help identification.

Resists **-196 °C** and **autoclavable** up to **121 °C**.

Sections will hold 81 tubes up to 12 mm diameter and 77 mm height.

Suitable with tubes: **400500, 409003.2, 409108, 409108.1, 801175T, 901075, 409003.1, 409107, 409107.1, 801075, 801275.**



code	colour	quantity	weight	volume
U-9980A	●	1	0.18	0.0021
U-9980N	○	1	0.18	0.0021



Rack 7x7 height 96

Polypropylene rack.

Dimensions with lid: 133 x 133 x 96 mm.

Available in fluorescent colours with transparent lid to help identification.

Resists **-196° C** and **autoclavable** up to **121 °C**.

Sections will hold 49 tubes up to 16mm diameter and 93 mm height.

Ideal for tubes 16x90-92 mm or similar tubes.



code	colour	quantity	weight	volume
U-7796V	●	1	0.17	0.0021

Rack 9x9 height 96

Polypropylene rack. Dimensions with lid: 133 x 133 x 96 mm.
Available in fluorescent colours with transparent lid to help identification.
Resists -196° C and autoclavable up to 121 C.
Sections will hold 81 tubes up to 12 mm diameter and 93 mm height.

Suitable with tubes: 300700, 300701, 300702, 300700.4, 300704, 300700.5, 300700.6, 300700.7, 300800, 300800.1, 300801, 300800.2, 300804, 301500, 400700, 400800, 400800.1, 409003.1, 409003.2, 409107, 409108, 409107.1, 409109, 409108.1, 409109.1, 801175T, 801275, 901275.



code	colour	quantity	weight	volume
U-9996A	●	1	0.20	0.0021
U-9996N	○	1	0.20	0.0021

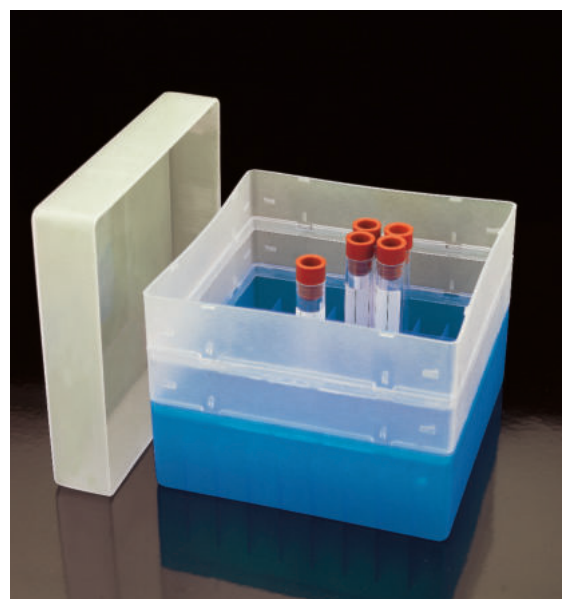

Rack 5x5 round hole height 105

Polypropylene rack.
Dimensions with lid: 133 x 133 x 105 mm.
Available in fluorescent colours with transparent lid to help identification.
Resists -196° C and autoclavable up to 121 °C.
Sections will hold 25 tubes up to 17 mm diameter and 102 mm height.

Suitable with tubes: 300705, 300707, 300900, 301200, 301201, 301202, 301700, 400705, 400900, 401200, 401201, 401204, 401700, 713100, 716100, 810100T, 913100, 916100.



code	colour	quantity	weight	volume
U-105105A	●	1	0.18	0.0023



Rack 5x5 round hole height 128

Polypropylene rack.
Dimensions with lid: 133 x 133 x 128 mm.
Available in fluorescent colours with transparent lid to help identification.
Resists -196° C and autoclavable up to 121 °C.
Sections will hold 25 tubes up to 17 mm diameter and 125 mm height.
Alphanumeric codification visible next to the holes.

Suitable with tubes: 300705, 300707, 300900, 300904, 300907, 300908, 301200, 301201, 301202, 301212, 301213, 301403, 400705, 400900, 401200, 401201, 401204, 401403, 401700, 409920, 429910, 429940, 429942, 429945, 713100, 716100, 810100T, 913100, 916100.



code	colour	quantity	weight	volume
U-15128A	●	1	0.20	0.0033
U-15128AM	●	1	0.20	0.0033
U-15128N	○	1	0.20	0.0033



Stainless steel racks and baskets

For over 25 years Deltalab has been producing a range of fine handmade stainless steel Racks and Baskets.

Materials of the highest quality are used to ensure final products have top finishings and are sturdy and durable.

The base of all racks and baskets are manufactured from a very strong stainless steel mesh. Handmade production enables Deltalab to manufacture **Racks and Baskets customised** to your own specifications.

Just indicate the product size you need and Deltalab will provide a product made to your own requirements.

Most racks can be manufactured with a stainless steel side identification plate upon request.

Also can be made with safety lid for transport.

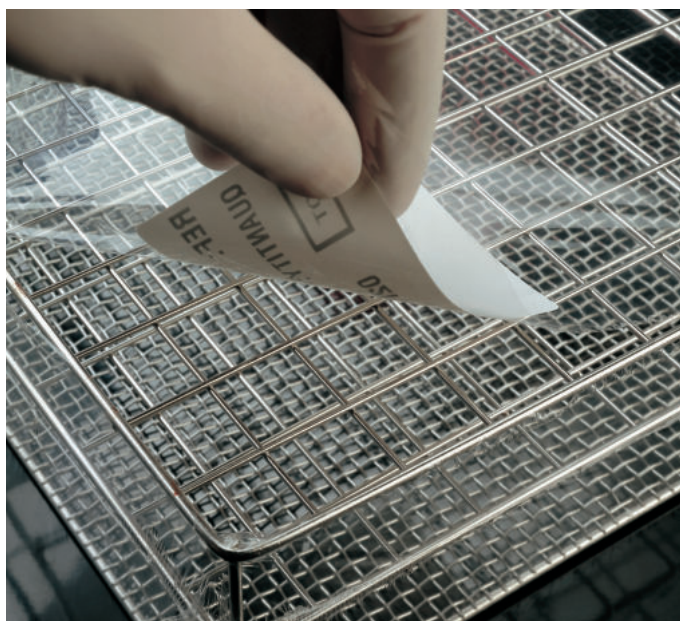

Aluminium racks 10 x 5 holes

Stackable. Alpha-numerical index for better sample location. Supplied encased and interlocked, wrapped in a protecting film. Code **Z-300** suitable for 12 ml screw tubes, series **301402**, and for 15 ml centrifuge tubes, series **429900** (See chapter of tubes)

code	dimensions mm	Ø hole mm	case quantity	case weight	case volume
Z-100	165 x 85 x 45	12	10	1.26	0.010
Z-250	195 x 100 x 45	15	10	1.63	0.011
Z-300	220 x 110 x 45	17	10	1.86	0.010

Aluminium racks 5 x 5 holes

Stackable. Alpha-numerical index for better sample location. Supplied encased and interlocked, wrapped in a protecting film. Code **Z-075** suitable for 12 ml screw tubes, series **301402**, and for 15 ml centrifuge tubes, series **429900** (See chapter of tubes).

code	dimensions mm	Ø hole mm	case quantity	case weight	case volume
Z-050	100 x 100 x 45	15	10	0.86	0.010
Z-075	110 x 110 x 45	17	10	1.06	0.010

Minimum unit sale: 1

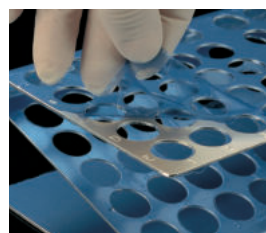

Stainless steel racks 10 x 5 holes

Stackable. Alpha-numerical index for better sample location. Supplied encased and interlocked, wrapped in a protecting film. Code **Z-600** suitable for 12 ml screw tubes, series **301402**, and for 15 ml centrifuge tubes, series **429900** (See chapter of tubes)

code	dimensions mm	Ø hole mm	case quantity	case weight	case volume
Z-500	165 x 85 x 50	12	10	3.04	0.012
Z-550	195 x 100 x 50	15	10	3.94	0.010
Z-600	220 x 110 x 50	17	10	4.48	0.010

Stainless steel racks 5 x 5 holes

Stackable. Alpha-numerical index for better sample location. Supplied encased and interlocked, wrapped in a protecting film. Code **Z-800** suitable for 12 ml screw tubes, series **301402**, and for 15 ml centrifuge tubes, series **429900** (See chapter of tubes).

code	dimensions mm	Ø hole mm	case quantity	case weight	case volume
Z-700	85 x 85 x 50	12	10	1.90	0.010
Z-800	110 x 110 x 50	17	10	2.46	0.010

Minimum unit sale: 1





Stainless steel racks

For tubes of 12 mm Ø, hole 13 mm Ø.



code	length x width x height mm	tubes capacity	quantity	weight	volume
F-200	155 x 155 x 35	100 (10 x 10)	1	0.20	0.0013
F-210	155 x 80 x 35	50 (10 x 5)	1	0.13	0.0006
F-240	91.5 x 63 x 35	24 (6 x 4)	1	0.07	0.0004
F-211	150 x 80 x 70	50 (10 x 5)	1	0.14	0.0016



Stainless steel racks

For tubes of 14 mm Ø, hole 15 mm Ø.



code	length x width x height mm	tubes capacity	quantity	weight	volume
B-200	175 x 175 x 60	100 (10 x 10)	1	0.24	0.0028
B-210	175 x 85 x 60	50 (10 x 5)	1	0.15	0.0012
B-220	347 x 87 x 60	100 (20 x 5)	1	0.20	0.0025
B-240	110 x 75 x 60	24 (6 x 4)	1	0.10	0.0010

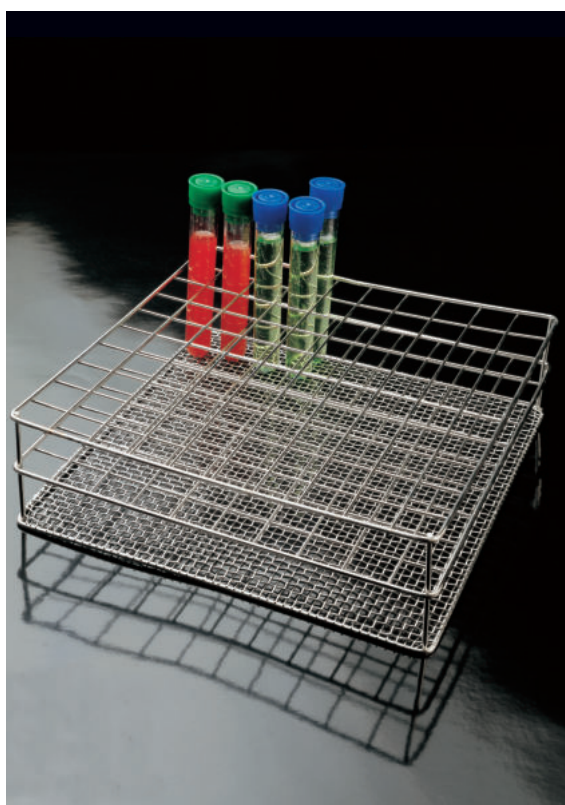

Stainless steel racks

For tubes of 18 mm Ø, hole 19 mm Ø. Codes **A-202**, **A-212**, **A-222** and **A-242** are suitable for 12 ml screw tubes, series **301402**, and for 15 ml centrifuge tubes, series **429900** (See chapter of tubes).



code	length x width x height mm	tubes capacity	quantity	weight	volume
A-201	210 x 210 x 40	100 (10 x 10)	1	0.33	0.0028
A-211	210 x 110 x 40	50 (10 x 5)	1	0.18	0.0012
A-231	169 x 128 x 40	48 (8 x 6)	1	0.20	0.0008
A-241	125 x 85 x 40	24 (6 x 4)	1	0.09	0.0006
A-251	87 x 65 x 40	12 (4 x 3)	1	0.07	0.0004
A-200	210 x 210 x 60	100 (10 x 10)	1	0.32	0.0043
A-210	210 x 110 x 60	50 (10 x 5)	1	0.19	0.0021
A-230	165 x 125 x 60	48 (8 x 6)	1	0.17	0.0012
A-240	125 x 85 x 60	24 (6 x 4)	1	0.11	0.0001
A-250	87 x 65 x 60	12 (4 x 3)	1	0.07	0.0007
A-260	310 x 210 x 59	150 (15 x 10)	1	0.20	0.0025
A-202	210 x 210 x 85	100 (10 x 10)	1	0.34	0.0062
A-212	210 x 110 x 85	50 (10 x 5)	1	0.21	0.0034
A-222	415 x 110 x 85	100 (20 x 5)	1	0.39	0.0065
A-242	125 x 85 x 85	24 (6 x 4)	1	0.11	0.0014

Racks for containers up to 23 mm Ø

Made of stainless steel. 25 mm square holes.



Suitable for glass tubes shown on pages 153-155



code	length x width x height mm	tubes capacity	quantity	weight	volume
D-200	265 x 265 x 85	100 (10 x 10)	1	0.50	0.0078
D-230	219 x 166 x 85	48 (8 x 6)	1	0.26	0.0042
D-240	165 x 110 x 85	24 (6 x 4)	1	0.16	0.0020
D-250	111 x 84 x 85	12 (4 x 3)	1	0.10	0.0013

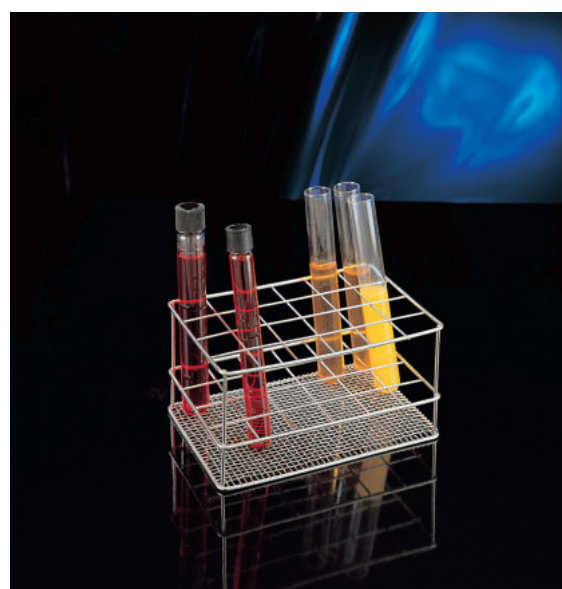

Racks for containers up to 28 mm Ø

Made of stainless steel. 30 mm square holes.



Suitable for containers shown on pages 116-117



code	length x width x height mm	tubes capacity	quantity	weight	volume
C-211	315 x 160 x 60	50 (10 x 5)	1	0.30	0.0039
C-256	200 x 70 x 60	12 (6 x 2)	1	0.13	0.0012

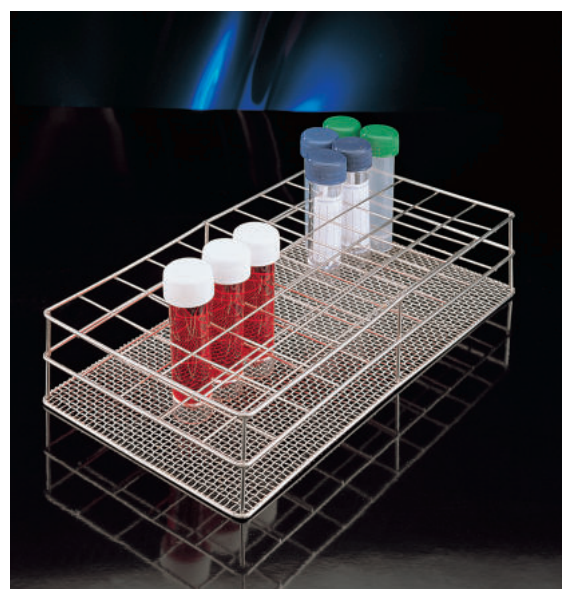

Racks for containers up to 28 mm Ø

Made of stainless steel. 30 mm square holes.



Suitable for containers shown on pages 116-117



code	length x width x height mm	tubes capacity	quantity	weight	volume
C-200	315 x 315 x 40	100 (10 x 10)	1	0.53	0.0052
C-254	195 x 65 x 40	12 (6 x 2)	1	0.12	0.0008



Racks for containers up to 30 mm Ø



code	length x width x height mm	containers capacity	quantity	weight	volume
R-292	137 x 104 x 85	12 (3 x 4)	1	0.12	0.0017
R-293	171 x 171 x 85	25 (5 x 5)	1	0.22	0.0035
R-281	138 x 70 x 92	8 (4 x 2)	1	0.11	0.0017
R-282	138 x 138 x 92	16 (4 x 4)	1	0.15	0.0020
R-283	206 x 206 x 89	36 (6 x 6)	1	0.60	0.0050

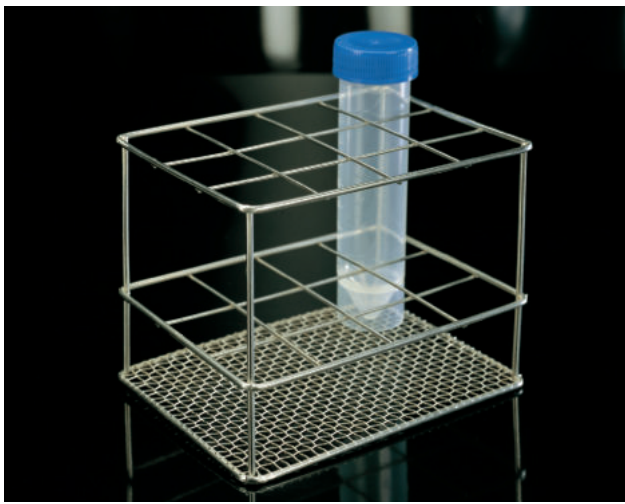

50 ml conical tubes made of transparent polypropylene. Suitable for centrifugation. Sterile and non sterile version skirted and not skirted.



Find our 50 ml centrifuge tubes at chapters.



Racks for containers up to 38 mm Ø



Suitable for containers shown on pages 116-121



code	length x width x height mm	containers capacity	quantity	weight	volume
L-250	170.5 x 129 x 45	12 (4 x 3)	1	0.14	0.0013
L-240	255 x 170 x 43	24 (6 x 4)	1	0.25	0.0023

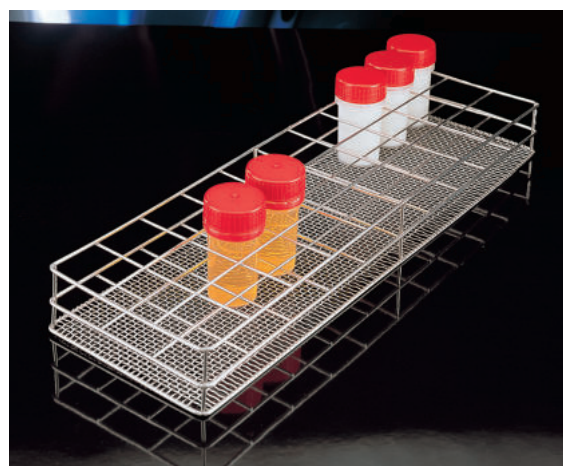

Racks for containers up to 47 mm Ø



Suitable for containers shown on pages 116-121



code	length x width x height mm	containers capacity	quantity	weight	volume
I-240	315 x 210 x 45	24 (6 x 4)	1	0.35	0.0042
I-250	210 x 160 x 45	12 (4 x 3)	1	0.25	0.0022

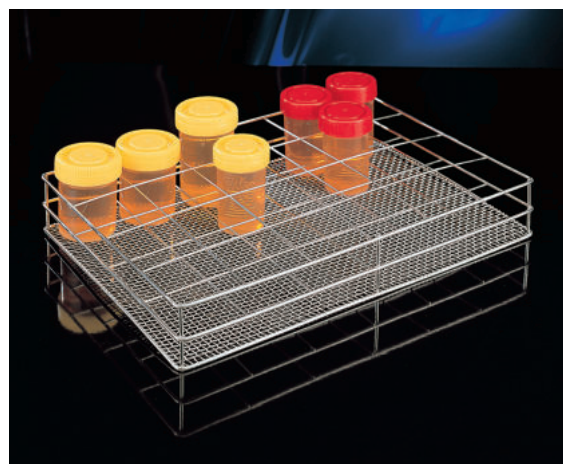

Racks for containers up to 58 mm Ø



Suitable for containers shown on pages 116-124

code	length x width x height mm	containers capacity	quantity	weight	volume
N-240	393 x 262 x 45	24 (6 x 4)	1	0.46	0.0056
N-250	393 x 132 x 45	12 (6 x 2)	1	0.37	0.0029

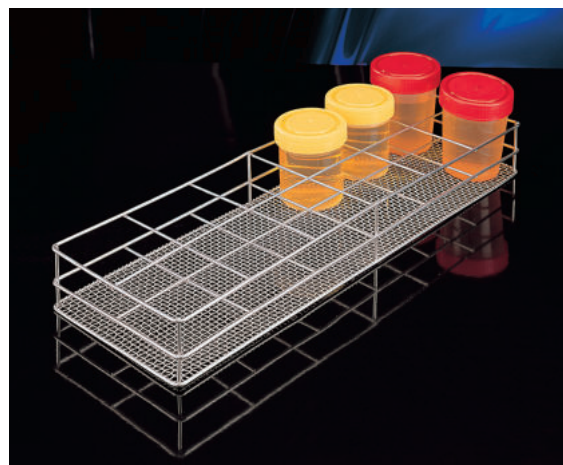

Racks for containers up to 58 ml Ø, with lid

Made of stainless steel with a lid. Hole of 63 mm.
Ideal for carrying containers, as they stand firmly in the rack thanks to the lid.



Suitable for containers shown on pages 116-124



code	length x width x height mm	containers capacity	quantity	weight	volume
NT-250	391.5 x 133.5 x 85	12 (6 x 2)	1	0.45	0.0050





Bottle carrier with folding handlers

Manufactured in stainless steel and designed for the transport of six 1 liter bottles such as chemical reagent bottles.



See our range of bottles and containers in chapter **Laboratory and industrial packaging**



code	length x width x height mm	quantity	weight	volume
19700	380 x 240 x 130	1	1.34	0.018



Baskets with folding handles

Made of stainless steel. Features a strong woven mesh base. For bottles and containers.



code	length x width x height mm	quantity	weight	volume
With dividers every 12 cm. 4 departments				
H-261	480 x 300 x 150	1	1.84	0.022
Without dividers				
H-260	480 x 300 x 150	1	1.18	0.020



Instrument trays

Made of stainless steel thick woven mesh. Reinforced construction to withstand weight. With not folding handles.



code	length x width x height mm	quantity	weight	volume
T-200	370 x 240 x 80	1	1.06	0.016
T-210	360 x 260 x 80	1	1.12	0.020

Baskets for autoclave

Stackable baskets made of stainless steel.



code	length x width x height mm	quantity	weight	volume
H-290	470 x 300 x 200	1	1.40	0.028
H-295	570 x 300 x 200	1	1.66	0.039



Square baskets with optional lid

Made of stainless steel. Feature a strong woven mesh base. Baskets have a folding handle for more convenience and are available with or without lid. To order baskets with lids, simply add **T** to the end of product code (ex: **H-200T** to order the first model with a lid). Minimum order quantity: 5 units. Other models with internal divisions are available on request. Please ask our commercial department for more details.



code	length x width x height mm	quantity	weight	volume
H-200	120 x 120 x 145	1	0.26	0.004
H-210	160 x 160 x 140	1	0.40	0.005
H-215	140 x 140 x 140	1	0.50	0.003
H-220	210 x 210 x 180	1	0.65	0.008
H-240	300 x 300 x 200	1	1.00	0.020



Round baskets with handle

Made of stainless steel, the base of these baskets is reinforced by a thick stainless steel mesh for added strength. Baskets feature a folding handle for more convenience. Other models with inner crossed dividers are available on request. Please ask our commercial department for more details.



code	height mm	diameter mm	quantity	weight	volume
R-200	125	150	1	0.22	0.003
R-215	150	200	1	0.35	0.006
R-220	200	200	1	0.52	0.008
R-230	180	210	1	0.47	0.008
R-240	180	230	1	0.56	0.010
R-250	180	240	1	0.53	0.010





Stainless steel basket for blood collection

Manufactured in stainless steel. Ideal to collect blood samples at hospital chambers, and carry them to and inside the laboratory.

The basket includes:

Picture A: A-295, rack for 64, 10 ml tubes (95 x 15 mm).

Picture B: B-240, rack for 24, 5 ml tubes (75 x 12 mm).

Picture C: A-261, rack for 28, 5 ml tubes (50 x 15 mm flat bottom).

Picture D: CP-24, small-sized basket for 24 slides vertically placed.



code	description	length x width x height mm	quantity	weight	volume
H-401	basket with racks	340 x 290 x 85	1	1.40	0.008

Code H-401 is compound of:

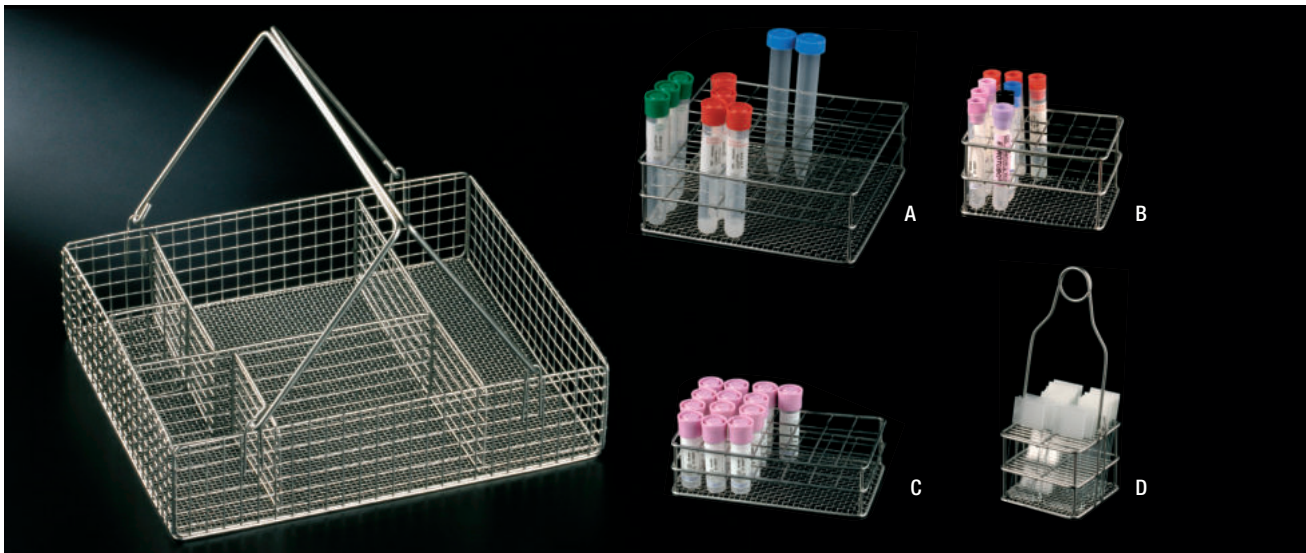

Racks are supplied with no tubes nor slides.



Plastic tray for blood collection tubes

Made of sturdy autoclavable polypropylene. Colour: white. Ideal to carry material from lab to patient. Designed for flexibility and versatility, this tray can be arranged to meet your specific needs. It includes two 40-place test tube supports (for tubes up to \varnothing 16 mm) and one 18-place slide holder (for 76 x 26 mm slides), a large requisition section, and adjustable partitions to hold varied materials. The handle is formed by an end mounted, detachable loop that is 178 mm high.



code	dimensions mm	quantity	weight	volume
M-300	356 x 292 x 51	1	1.38	0.017

Racks for bags

Made of stainless steel, specially designed for Stomacher type homogenizer bags. Dimensions 390 x 200 x 240 mm. See bags on chapter 15.



See more Stomacher type homogenizer bags in chapter **Containers. Sampling**



code	description	quantity	weight	volume
15006	rack for 14 bags	1	1.77	0.039
983047	clips to adjust bags	200	4.30	0.0114

Customer-designed models can be produced. Please ask the commercial department.



Petri dish baskets

These stainless steel baskets are suitable for dishes of diameter up to 10 cm. Two models available to hold 16 or 32 Petri dishes.



code	description	dimensions* mm (height without handle)	height handle mm	case quantity	case weight	case volume
H-600	1 section, holds up to 16 dishes	105 x 110 x 250	105	1	0.16	0.005
H-601	2 sections, holds up to 32 dishes	105 x 215 x 250	100	1	0.31	0.010

*Longueur x largeur x hauteur. Hauteur avec poignée. 360 mm. Nous pouvons fabriquer d'autres modèles sur comande.



Special baskets and trays for slides

Baskets are manufactured from stainless steel wire. Model CP-30 has folding handles.



See more staining systems in chapter **Histology, microscopy and staining**



code	description	dimensions mm	case quantity	case weight	case volume
CP-30 H	basket for 30 horizontal slides	172 x 86	1	0.12	0.001
CP-45 H	basket for 45 horizontal slides	235 x 85	1	0.17	0.002
CP-30	basket for 30 vertical slides	70 x 90	1	0.20	0.003



Stainings racks for microscope slides

Made of stainless steel.



code	description	quantity	weight	volume
S-004	for 12 slides length: 435 width: 85	1	0.25	0.003
S-002	for 24 slides length: 435 width: 175	1	0.36	0.003
S-003	without divisions length: 435 width: 85	1	0.21	0.003

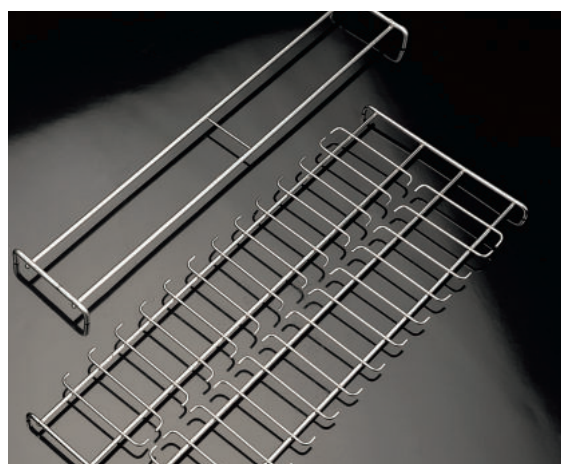





**HYGIENE, SAFETY
AND GENERAL LABWARE**



 **deltalab**

Clasificación of waste by type:

Type I waste: medical waste treated as municipal waste. Easy management (cardboard, paper, office equipment, kitchens, garages, gardening and non-infectious patients waste).

Type II waste: non specific medical waste. Preventive measures in the handling, collection, storage and transport in the field of health center (dressing materials, plasters, clothing and single-use material contaminated with blood, secretions and/or excretions).

Type III waste: specific health waste or risk waste. Preventive measures in the handling, collection, storage, transportation, treatment and disposal, as they may pose a health risk to workers and the public. They can be divided into 5 groups: medical waste or infectious anatomical waste, blood and blood products in liquid, needles, sharps and live attenuated vaccines.

Type IV waste: waste specified in singular regulations. Subject to especial requirements from the point of view of hygiene and environment. Include: cytostatic waste, chemical residues, expired pharmaceuticals, minerals and synthetic oils, waste metals, radioactive waste and human anatomical remains entity.

Source: NTP 372 – Spanish National Institute of Safety and Health at Work.

Safety containers

Containers manufactured with virgin raw materials enabling incineration; four and six liters containers are made in autoclavable polypropylene, the rest in polyethylene. **Suitable for solid waste type II and III.**

They are compound by a body bearing the hazard warning label, and two lids:

- The first offers an entire opening, taking advantage of the total diameter of the mouth of the container; very useful to throw away bigger volume waste. May be closed hermetically and definitively
- The secondary one presents a partial opening, which may be closed temporarily or definitively. It embodies two devices in order to easy the extraction/ disconnection of dental and analytical needles, and a 70 x 42 mm rectangular orifice. All containers, excepting code **241500**, embody a handle.

mod.	code	capacity l	material (body and lid)	Ø mouth mm	Ø base mm	height mm	case quantity	case weight	case volume	cases per pallet
1	242000	2.0	PE	143	125	160	60	8.90	0.116	12
2	243500	3.75	PP	195	175	157	40	10.00	0.144	12
3	246000	6.0	PP	220	194	203	20	7.82	0.146	12
4	240007	7.0	PE	220	190	238	20	7.80	0.144	12



In accordance with major European and international standards (ONU ADR, etc.)



Safety containers

These containers are manufactured in virgin raw materials enabling incineration.

Suitable for solid waste type II and III.

They are compound by a body bearing the hazard warning label, a handle, and two lids, allowing two using options:

- Total opening, taking advantage of the total diameter of the mouth of the container; very useful to throw away bigger volume waste
- Partial opening, 120 mm diameter, usable for syringes, contact plates, and midsize waste

Code **240028** is total opening only.

mod.	code	capacity l	material (body / lid)	Ø mouth mm	Ø base mm	height mm	sales unit	sel.ut. weight	sel.ut. volume	cases per pallet
1	240011	11	PE / PP	260	226	255	10	4.69	0.050	400
2	240021	20	PP / PP	315	277	348	10	9.39	0.090	190
3	240028	25	PP / PP	322	278	391	10	9.71	0.100	100

In accordance with ONU standards and major European standards.



Safety labelling

Permanent adhesion labelling to alert from risk or danger.

Labels are shiny and fluorescent.

In compliance with international safety standards.

Recommendable temperature of use:

- Codes **901531**, **901533**: from **-50 °C** to **105 °C**

mod.	code	description	bag quantity	bag weight	bag volume
1	901531	roll of 500 labels (labels size 25 x 25 mm)	500	0.07	0.0002
2	901533	bag of 10 units 200 x 250 mm	10	0.06	0.0010



Needle collection container

Made of high density polyethylene. Instructions for use (in English and Spanish) are printed on the containers. Suitable for waste type III (see page 242).

Capacity: 1 l. It features two caps.

The first one has a mouth which embodies three different devices to remove needles. The other one is designed to close the container temporarily or definitively.

Can be incinerated without release of toxic fumes, like all our containers.

code	colour	dimensions mm	case quantity	case weight	case volume
90	yellow	Ø mouth 70; Ø base 100; height with cap 173	76	7.90	0.150



Safety containers

Manufactured in polypropylene, they are also shockproof, perforation and solvents resistant, and can be incinerated. Two ways of locking: provisional; and permanent. **Autoclavables**. Portable models **260000** and **232806** are designed to be easy opened and closed with just one hand.

1. **232810**, 0.20 l capacity. Approximate capacity for 100 needles. Suitable for needles and lancets. Device **type A**. Easy opening and closure with just one hand.
2. **260000**, 0.45 l capacity. Designed for those people who need regular injections and have to carry a needle container. With a device **type B** and a handle. Black colour.
3. **232811**, 0.45 l capacity. Similar to the previous model, but in yellow colour, and featuring **device C**.
4. **232806**, 0.6 l capacity. Usable for insulin needles, it is also right for complete syringes. Features a device **type A** and a handle on one side.
5. **232809**, 1 l capacity. Suitable in places where waste quantity to be disposed of is small. With a handle and devices **A and C**.
6. **232808**, 2 l capacity. Features devices **type D**.
7. **232801**, 4 l capacity. The most used container for discarding residues in general. Embodies devices **type D** and a handle.
8. **232802**, 7 l capacity. Its height makes it ideal for contaminated pipettes. With devices **type D**.

All models, excepting **232810**, **232811**, **260000**, and **232806**, embody a socket to place needle caps in vertical position.

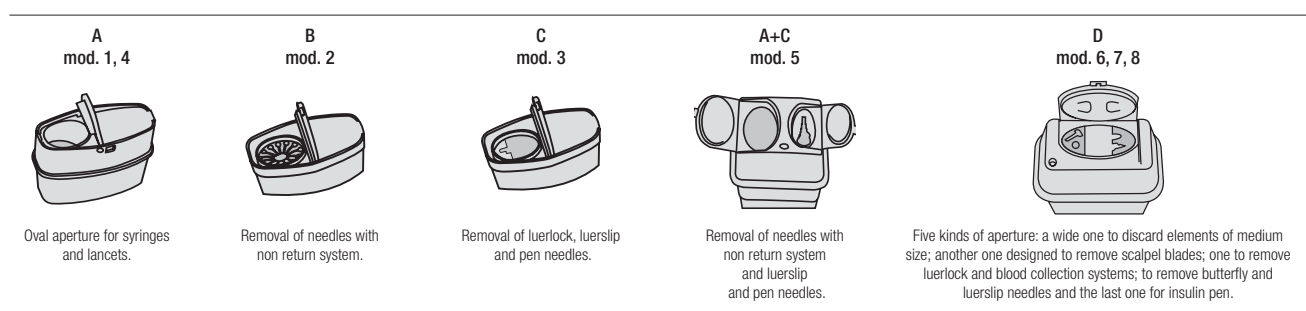

All the them meet ADR UN. Medical waste unspecified Type II and III.
They are also in accordance with BS 7320, EN ISO 23907:2012, NFX 30 511:2015, NF 302, Kyte Mark, TRBA 250 and Ö norm.

mod.	code	capacity l	container dimensions mm	opening devices	useful capacity l	container weight g	case quantity	case weight	case volume
1	232810	0.20	79 x 37 x 146	A	0.20	64	100	6.22	0.040
2	260000	0.45	105 x 50 x 167	B	0.35	88	100	10.00	0.080
3	232811	0.45	105 x 50 x 167	C	0.35	88	100	9.88	0.080
4	232806	0.60	110 x 55 x 220	A	0.47	112	100	12.30	0.112
5	232809	1.00	107 x 90 x 190	A+C	0.81	125	100	13.70	0.093
6	232808	2.00	195 x 120 x 170	D	1.60	216	50	12.50	0.092
7	232801	4.00	175 x 175 x 248	D	3.00	310	50	16.73	0.130
8	232802	7.00	175 x 175 x 382	D	5.60	434	50	23.78	0.200

These models are constantly updated; design can be slightly modified.



Rectangular waste containers (PP)

Made of yellow, perforation resistant, virgin polypropylene. Suitable for solid or semi-solid waste, II and III groups. Lids feature a central handle for a better handling in the daily use and also while carrying containers. Secure closure thanks to their fourteen closing points. Lateral handles for further help carrying. Can be incinerated with no release of toxic fumes. Stackable when empty, or full and closed.

Minimum wall thickness: 2.5 mm.

Closing sealed for air and gas.

Manufactured following new French Standard NFX 30 505.



mod	code	capacity l	container dimensions mm	maximum load (ADR) kg	weight ut. g	pallet dimensions	pallet quantity	case quantity	case weight	case volume
1	240035	30	415 x 314 x 373	14	1,400	80 x 120 x 200	100	10	14.91	0.15
2	240065	60	415 x 314 x 575	25	1,984	80 x 120 x 200	100	10	19.84	0.17

Cardboard waste containers

Cardboard containers with lid, designed for storage and disposal of group II solid and semi-solid waste. With an integrated low density polyethylene bag (stuck in their interior). They can be incinerated without release of toxic fumes. The lid features two seals. One temporary that will avoid unpleasant smells and eliminate the risk of contamination while using the container. The second one is a definitive, positive seal: closing the bag with a belt already included, sealing the lids, and reinforcing them with an adhesive tape.

These containers embody lateral handles.

Model 3, code **250050**, 50 l capacity, is made of cardboard 2.7 mm minimal thick. PEBD 60 µ bag, adhered to the base and the walls. **Its height allows users not to need to lean forward as they throw away waste.** Easy to assemble thanks to its auto-mountable bottom. A maximum filling line is printed on its body.

Model 4, code **270045**, 50 l capacity, is manufactured in **reinforced cardboard, double thickness** (4 mm minimum). PEBD bag 54 µ adhered to the base. Safe closure with the help of raised edges. Both are printed with the biohazard anagram and text; assembling and closing instructions and drawings; identification formulary, and standards. Suitable for liquid and solid products or products with a certain level of humidity. Containers are supplied folded up for space-saving. Those containers are not suitable for needle disposal. For this purpose see the special containers on previous pages.

In accordance with UN ADR (road transport), and manufactured pursuant new French Standard NFX 30 507.



mod	code	capacity l	container dimensions mm	maximum load (ADR) kg	weight ut. g	pallet dimensions	pallet quantity	case quantity	case weight	case volume
3	250050	50	263 x 263 x 756	12.5	660	100 x 120 x 180	40 x 10	400	264	1.80
4	270050*	50	355 x 263 x 485	12.5	570	355 x 263 x 485	330	300	155	0.09

* Weight without bag. The inner bag weighs 0.070 kg.





Sterilization indicator tapes

Self-adhesive sterilisation indicator tapes made of semicreped paper. It sticks on different surfaces such as plastic, metal, fabrics, paper, cardboard, etc. The tapes have high tack adhesive and they offer good resistance to heat and moisture. Also, the tapes are resistant and it is hard to break them.

1. Code 191050

Tape designed to check what individual units have been exposed to Ethylene Oxide (EO) sterilisation. Also, it is used to distinguish between sterilised and non sterilised units during their storage. The word GAS in brown changes its colour into green after the EO sterilisation, by the following specifications:

- Exposition to 600 mg/l EO and 60% of relative humidity (RH) for minimum 30 min. at 30 °C.

2. Code 191051

Tape designed to use with individual units, to check if the units have been exposed to dry heat/poupinel sterilisation, and to distinguish between sterilised units and non sterilised units during their storage. It must not be used in wet processes. Signals in V shape convert themselves from light green into intense green when it has been sterilised according to the following specifications:

- Exposition in dry air at 160 °C or more for minimum 30 minutes.

3. Code 191052

Tape designed to be used with individual units to show that they have been exposed to steam (autoclave) sterilisation, and to distinguish between sterilised units and non sterilised units. Not to be used in any other process than steam sterilisation (autoclave). The tape is lead free. Green printed strips turn to brown after the sterilisation of the tape by the following specifications:

- Exposition at 121 °C for 10 min.
- Exposition at 134 °C for 2 min.

Validity of the product: 24 months from the production date.

mod.	code	type of sterilisation	length. mm	width mm	case quantity	case weight	case volume
1	191050	ethylene oxyde gas	50	19	8	0.93	0.0027
2	191051	dry heat (poupinel)	50	19	8	1.06	0.0043
3	191052	autoclave	50	19	8	1.08	0.0043



Sterilization indicator tapes

For steam **autoclave**.

Resistance to cold: -40 °C.

Model 1: The tape has printed on it **CONTAMINATED**.

After sterilisation to 121 °C the word **STERILIZED** appears.

Model 2: The tape has printed on it **-Batch, -Con. (Control) and -Date**. After sterilisation to 121 °C the word **STERILIZED** appears.

mod.	code	description	case quantity	case weight	case volume
1	191222	roll of 19 mm x 13 m	8	0.33	0.0007
2	191223	roll of 19 mm x 13 m	8	0.33	0.0007

Bags for Autoclave

Printed with the biohazard graphic symbol and instructions of use in five languages. Do not close the bags hermetically when placing them in the autoclave a 121°C.

Code 200100 is made of an autoclavable polyethylene, while the rest of the codes are manufactured in autoclavable polypropylene.



code	dimensions cm	materiel	aprox. capacity l	tickness microns	bag quantity	bag weight	bag volume
200310	30 x 60	PP	12	37.5	500	5.99	0.013
200311	40 x 75	PP	24	37	300	6.10	0.023
200100	50 x 75	PE	34	30	100	2.05	0.006
200312	60 x 75	PP	49	37	200	6.25	0.020
200318	75 x 90	PP	100	37	100	4.36	0.011

Minimum order quantity: 50.000 pieces.



Autoclave resistant red bags

Heavy duty, high impact biohazard bags made of a 0.055 mm thick high molecular weight polypropylene blend.

They are autoclavable to 138 °C, saving autoclave time.

Bags printed with the standard biohazard warning symbol and precautionary procedures in four languages: English, Spanish, French and German.

They feature a sterilization indicator patch that darkens when exposed to steam sterilization. Do not close the bags hermetically when placing them in the autoclave.

code	dimensions cm	volume l	case quantity	case weight	case volume
200320	48 x 58	24.4	200	5.10	0.011
200321	65 x 91	75.1	200	10.93	0.017
200322	78 x 96	121.0	200	13.25	0.029



Bottles for sterilization

Made of soda glass 3.3. Autoclavable up to 140 °C.

Graduations printed in white colour. Screw caps (GL45) made of blue polypropylene.

Ribbed screw caps for a better handling. Drip ring on bottle neck to avoid dripping. Ideal for chemical reagents and culture media.

They can be used to freeze substances up to -40 °C.

It is recommended to freeze them in an inclined position (ca 45°) and filled up to max. 3/4.



code	capac. ml	screw	Ø ext. mm	height mm	case quantity	case weight	case volume
402001	100	GL45	56	100	10	1.80	0.004
402002	250	GL45	70	138	10	2.79	0.008
402005	500	GL45	86	176	10	4.22	0.015
402010	1,000	GL45	101	225	10	6.52	0.027
402020	2,000	GL45	136	260	10	10.54	0.059





Coloured adhesive tapes for sample identification

Ideal for use in freezers, autoclaves, etc. Peel off without leaving a sticky residue. Withstand temperatures from **-50 °C to 130 °C**.

High resistance to oils, acids, water, etc.
Suitable for glass, plastic, paper, metal and rubber surfaces.

Can be marked with pencil, ball-point pen, etc.

All tape models are 19 mm wide.

The code **191220** is a 12 roll tape metal dispenser that accepts 13 m rolls. The dispenser has the following dimensions: 31x7x13 mm.

code	colour	Ø mm	case quantity	case weight	case volume
13 m tape roll					
191221/1	white	26	16	0.64	0.001
191221/2	red	26	16	0.64	0.001
191221/3	yellow	26	16	0.64	0.001
191221/4	green	26	16	0.64	0.001
191221/5	orange	26	16	0.64	0.001
191221/6	blue	26	16	0.64	0.001
55 m tape roll					
191221.1	white	76	12	1.78	0.005
191221.2	red	76	12	1.78	0.005
191221.3	yellow	76	12	1.78	0.005
191221.4	green	76	12	1.78	0.005
191221.5	orange	76	12	1.78	0.005
191221.6	blue	76	12	1.78	0.005
Accessoires					
191220	dispenser	-	1	2.75	0.005

Minimum order quantity: 1



Adhesive labels

White colour.

code	description	bag quantity	bag weight	bag volume
901031	55 x 37 mm printed	5.000	1.15	0.002
901031.2	55 x 37 mm plain	5.000	1.20	0.003
901030	35 x 25 mm printed	2 x 7.500	2.25	0.006

Check with our commercial department for other measures.

Safety glasses

Made of polycarbonate (1.5 mm thickness).
Scratch resistant, antifogging, antistatic lenses.
Protect against UV rays.
With lateral vents. Conform to EN 166 standard.
Eyepiece dimensions: 145 x 65 mm.



code	description	quantity	weight	volume
19385	glasses	5	0.49	0.003



Safety glasses

Made of polycarbonate (2 mm thickness).
Can be worn over conventional corrective glasses.
Conform to EN 166, EN 167 and EN 168.
Standard.
Eyepiece dimensions: 152 x 60 mm.



code	description	quantity	weight	volume
19386	glasses	12	0.69	0.004



Emergency eyewash bottle

Made of low density polyethylene, the bottle is flexible and easy to squeeze. The bottle has an eyecup with a snap-on cap. The eyecup has a perforated plate to break up the stream providing a gentle spray to the eye. A capped air vent valve prevents drawback of contaminated eye wash into bottle. Contaminated wash exits through a drain tube, which rotates in any direction.

Instructions for use printed in various languages.

Bottle capacity: 1 l.

Supplied empty.

code	capacity ml	case quantity	case weight	case volume
19384	1,000	1	0.26	0.004





EUROTUBO® Pipetting bulb

This one-handed design is the simplest safety pipette filler to use available. Manufactured in natural orange rubber.

Approx. drawn capacity: 25 ml.

Single hand use, only two operating points. Evacuate via the automatic valve.

Standard model, accommodates all pipettes. Ability to clean inside of bulb by removing patented valve and rinsing out.

code	description	bag quantity	bag weight	bag volume
19200	pipetting bulb	1	0.05	0.0004



Pipetting bulb

Made of rubber. Used to avoid mouth pipetting and contamination risk.

Can be opened, cleaned and **autoclaved**.

Ideal for Wintrobe and Westergren pipettes.



code	description	bag quantity	bag weight	bag volume
19201	red pipetting bulb	1	0.04	0.0002



Pipette pumps

Several models for various pipette volumes.

Designed for fast and efficient pipetting with simple, one handed operation.

Pipettes fit smoothly into collar.

Rotate the knurled thumb wheel on the side for precision filling or dispensing, and press the fast release lever for quick emptying.

Easy to use and easily disassembled for cleaning.

Sizes are colour coded.

Pipette pumps resist acids and alkalis.

Attention: New models coming soon.



code	description	colour	bag quantity	bag weight	bag volume
W-100	up to 2 ml	blue	1	0.06	0.0002
W-110	up to 10 ml	green	1	0.06	0.0002
W-120	up to 25 ml	red	1	0.06	0.0002

Pipette pump support rack

Made of acrylic resin and designed to keep in position 4 pipette pumps.

Suitable for the above pipette pumps.

code	dimensions mm	bag quantity	bag weight	bag volume
W-150	109 x 208 x 144	1	0.34	0.005

Wash bottles

Made a combination of high and low density polyethylene. Translucent bottle, with HDPE cap (blue), delivery tube and seal cap (natural).

Bottle caps are ribbed for a better handling.

High resistance to all liquids, acids and bases.

Include a large neck for safe and easy filling.

code	capac. ml	neck mm	base mm	height mm	case quantity	case weight	case volume
44330000	250	30	65	155	90	5.30	0.078
44300000	500	30	75	185	60	4.85	0.080
44310000	1,000	30	90	222	45	5.02	0.110



Wide mouth wash bottles

Translucent low density polyethylene bottles, with screw cap and delivery tube available in 3 different colours (natural, blue, yellow and red) for easy identification. Feature a one piece cap and delivery tube assembly, thus eliminating air or liquid absorption through the cap.

Include a wide neck for safe and easy filling.

Ribbed caps for a better handling while opening and closing.

Moulded-in graduations. 250 ml model is graduated in 25 ml increments, 500 ml model, in 100 ml increments.



code	capac. ml	cap colour	int. neck Ø mm	base Ø mm	height mm	case quantity	case weight	case volume
191637	250	natural	38	60	140	10	0.64	0.018
191637.04	250	blue	38	60	140	10	0.64	0.018
191637.06	250	yellow	38	60	140	10	0.64	0.018
191637.10	250	red	38	60	140	10	0.64	0.018
191638	500	natural	38	75	165	10	1.01	0.019
191638.04	500	blue	38	75	165	10	1.01	0.019
191638.06	500	yellow	38	75	165	10	1.01	0.019
191638.10	500	red	38	75	165	10	1.01	0.019



Integral wash bottles

Made of translucent polyethylene. Feature a one piece cap and delivery tube assembly, which eliminates air or liquid absorption through the cap and ensures a positive leaktight seal. To increase liquid flow, cut the tip of the delivery tube; close the tip by means of the cap attached to the delivery tube.

Caps are ribbed for a better handling while opening and closing.

Tagging points on neck and cap for a tamper proof closure. Bottles include a fill in line.

code	capac. ml	height mm	neck d/n std.	case quantity	case weight	case volume
191633	250	143	GL32	10	0.68	0.008
191634	500	181	GL32	10	0.84	0.015





Wood tongue depressors

Tongue depressor with smooth rounded edges. Made from high-quality wood to provide a smooth, splinter-free finish. Odour and taste-free. Maintains a high tensile strength. In addition to their traditional use, depressors can be used for spreading balms and ointments, for stirring liquids or mixing medicine, etc. The sterile models are supplied with "instructions for use". Size: 15 x 1.8 cm.



code	description	case quantity	case weight	case volume	cases per pallet
441142	non sterile	50 x 100	13.78	0.027	40
441242.2	STERILE EO individual flow-pack	4 x 500	12.66	0.070	24

Sterile models are supplied with "instructions for use".



Plastic tongue depressors

Made of polystyrene. Colour: cream. Tongue depressor with smooth rounded edges. Odour and taste-free. Maintains a high tensile strength. More flexible than wood depressors. Features a ribbed finger rest for easy handling. In addition to their traditional use, depressors can be used for spreading balms and ointments, for stirring liquids or mixing medicine, etc. Size: 16 x 2 cm.



code	description	case quantity	case weight	case volume	cases per pallet
441142.1	non sterile	6 x 250	8.30	0.014	108
441142.2	STERILE EO individual flow-pack	4 x 500	12.66	0.070	24

Sterile models are supplied with "instructions for use".



Absorbent paper

This 125 g/m² absorbent paper provides a total protection thanks to its two layers. The top side consists of a layer of cellulose of great liquid absorption power; the reverse side consists of a layer of polyethylene ensuring that it is completely waterproof. For use in the following applications:

- laboratory trays and tables protection
- pathological anatomy laboratories
- seed germination (between-paper method)
- spillage recovering using its leaktight surface
- particularly suitable for working with materials that are valuable (precious metals) or hazardous (toxic or corrosive materials)

Paper thickness: 0.250 mm. Absorption: 240 g/m². Klemm absorption: 86 mm.

code	description	case quantity	case weight	case volume
120003	50 m x 50 cm reel	1 reel	3.01	0.009
120002	50 x 50 cm sheets	1 x 100 sheets	2.90	0.008



Filter paper

Our range of filter paper reams is made from high quality cellulose fibres to ensure a good resistance to humidity and a high absorption capacity.

Pore diameter: ± 30-40 microns. For use in the following applications:

- laboratory worktop protection
- simple filtering operations for varied products
- labware sterilisation
- pharmaceutical product preparation

code	sheet size cm	grammage	thickness mm	Klemm absorp. (mm)	case quantity	case weight	case volume
120010	50 x 50 cm	73 g/m ²	0,170 ±0,02	89	1x100 sheets	2.04	0.006

Capillary rise of water. Klemm Method (UNE 57044): SL> 75 ST> 70.

Urine collection bottle

Made of polyethylene.

Colour: natural. The 19591 and 19591 / T codes have a 110 mm handle. The bottle has moulded-in graduations in 100 ml increments up to 1,000 ml. Total capacity: 1.1 l.

Rounded rim on the neck of the bottle. Inner diameter of the neck is 50 mm, outer diameter is 69 mm.

Supplied **individually wrapped**.

Can be sterilised by ethylene oxide.



	code	description	total capacity	case quantity	case weight	case volume	cases per pallet
	1	19591* without lid	1 l	60	5.40	0.160	12
	2	19591/T* with lid	1 l	60	6,54	0,160	12
NEW	3	C02 without lid, without handle	1 l	70	6.71	0.150	16

* Supplied with "instructions for use".



Bed pan

Made of white polypropylene.

Especially designed for disabled people, for the collection of urine and faeces.

Features **rounded edges** for more comfort.

L-shaped handle for a better handling.

Allows a secure one-handed grip and avoids accidental spillage.

Useful for hanging on handles, beds, etc.

Total capacity: 2.5 l.

Autoclavable.

Can be washed in automatic machines.

Supplied **individually wrapped**.



code	dimensions mm	case quantity	case weight	case volume	cases per pallet
19586	440 x 270 x 95	20	10.69	0.140	12

Supplied with "instructions for use".



Dental containers

Manufactured in polypropylene and intended for the hygienic storage and preservation of dental prostheses, orthodontic sections and dental splints.

It has flexible and waterproof walls and closure system by means of a front flange.

The open container is stackable, which reduces the space of storage, and stackable once closed, thanks to the projections in the base and the lid.

Contact the commercial department for individual packaging.



code	colour	case quantity	case weight	case volume
D01	white	300	9.4	0.070
D03	green	300	9.4	0.070



Glove properties chart

	LATEX	NITRILE	VINYL
Mechanical resistance			
Perforation	●	●	●
Tearing	●	●	●
Adequate for foodstuff handling	●	●	●
Comfort	●	●	●

Maximum resistance of nitrile gloves 125 °C.

- Excelent
- Good;
- Limited
- Not recommended

These indications are solely for information. It is strongly recommended that the user carries out preliminary testings.

Glove chemical resistance chart

Diluted mineral acids			
Hydrochloric acid	●	●	●
Chromic acid	●	●	●
Nitric acid	●	●	●
Perchloric acid	●	●	●
Phosphoric acid and Sulphuric acid	●	●	●
Ácidos concentrados			
Chlorhidric acid	●	●	●
Chromic acid	●	●	●
Nitric acid	●	●	●
Sulphuric acid	●	●	●
Hydrocarbon and oil by products			
Aniline	●	●	●
White spirit	●	●	●
Styrene	●	●	●
Gasoline, Hexane, Paraffine, Kerosene	●	●	●

CHOOSE YOUR GLOVE SIZE - MEASURE YOUR HAND

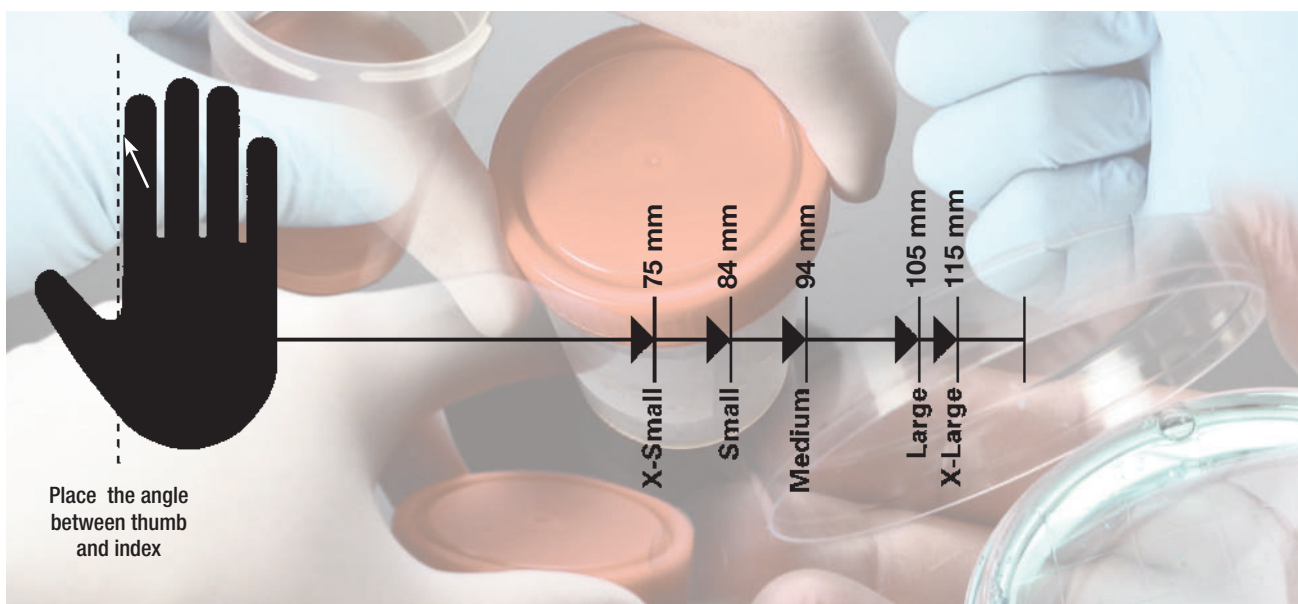

See more information about our gloves in Chapter 0. Technical Information (page 12)



Safety gloves

Provide superior protection when handling hot, cold or damp objects. Made of strong non toxic silicone rubber which resists tearing and withstands temperatures from **-55 °C** up to **260 °C**. Thumb and fingers fit into end pockets. The gripping surfaces have multiple concave tipped studs for non-slip grip (48+48 studs).

code	dimensions mm	case quantity	case weight	case volume
19270	190 x 100	1	0.19	0.001

Latex gloves

Single use gloves, suitable for medical, laboratory use, industries, etc. Made of top quality natural colour latex. Supplied in convenient dispenser boxes of 100 units. Ambidextrous, ergonomic and have beaded cuffs, which makes them more resistant. Non sterile. 2 versions: powder-free or pre-powdered. Pre-powdered model contains cornstarch.

In compliance with regulations:

- Registered as CE MDD
- Directive 93/42/EEC. Medical devices
- Directive on Personal Protective Equipment (PPE) 89/686/EEC (Category III)
- European Standards EN 455, EN 374, EN 420, EN 380.
- Micro perforations Inspection Level: AQL 1.5
- Free of all chemicals contained in the “candidate list” of REACH.

Thickness:

Latex gloves with powder
 Finger: 0,12 mm (± 0,03 mm)
 Palm: 0,09 mm (± 0,03 mm)
 Fist: 0,08 mm (± 0,03 mm)

Latex gloves without powder
 Finger: 0,10 mm (± 0,03 mm)
 Palm: 0,09 mm (± 0,03 mm)
 Fist: 0,07 mm (± 0,03 mm)



code	size	description	case quantity	case weight	case volume
1020LP	small (6-7)	powder-free	10 x 100	6.11	0.020
1020LM	medium (7-8)	powder-free	10 x 100	6.13	0.020
1020LG	large (8-9)	powder-free	10 x 100	6.96	0.020
1000LSP	extra-small (5-6)	pre-powder	10 x 100	5.40	0.018
1000LP	small (6-7)	pre-powder	10 x 100	5.60	0.018
1000LM	medium (7-8)	pre-powder	10 x 100	6.00	0.018
1000LG	large (8-9)	pre-powder	10 x 100	6.30	0.019

Expiration: 60 months



Nitrile gloves

Single-use gloves made of blue nitrile. Powder-free. Non sterile. Suitable for medical and laboratory use. Supplied in convenient dispenser boxes of 100 units. Opening box with pre-drilled at the top. Easy and convenient removal of the glove. Indication of height in dispenser box and carton. Maximum safety and waterproof gloves, they are three times more resistant than latex gloves. Antistatic, ambidextrous and ergonomic.

Beaded cuff, reinforced ensuring easy installation and preventing it from rolling. High sensitivity to touch. Finish: microtextured outer surface on the fingertips, it provides greater grip strength. Chlorinated inner surface, smooth and comfortable. Use temperature range: -20 °C to 50 °C. Free of protein. Made of materials suitable for food use.

In compliance with:

- CE marck According to Directive 93/42/CE.
- European Standards: EN 420, EN 374, EN 455, EN 388.
- Directives PPE: 89/686/EEC (Category III)
- ASTM D 6978-05, ASTM F 1671, ASTM F 1670

Thickness:

Finger: 0,10 mm (± 0,02 mm)
 Palm: 0,07 mm (± 0,02 mm)
 Fist: 0,05 mm (± 0,02 mm)



code	size	description	case quantity	case weight	case volume
4020NP	small (6-7)	powder-free nitrile gloves	10 x 100	3.90	0.021
4020NM	medium (7-8)	powder-free nitrile gloves	10 x 100	4.20	0.021
4020NG	large (8-9)	powder-free nitrile gloves	10 x 100	4.50	0.021

Expiration: 60 months



Measuring cylinders with pentagonal base

Material: polypropylene. Autoclavable up to 121 °C.
In compliance with ISO 6706 standard.

code	capac. ml	grad. ml	subdiv. ml	O.D. Ø mm	height mm	case quantity	case weight	case volume
408025	25	5	0.5	19	195	30	0.78	0.010
408050	50	10	1.0	26	200	30	1.10	0.010
408100	100	10	1.0	31	250	30	1.47	0.018
408250	250	20	2.0	41	315	12	1.40	0.015
408500	500	50	5.0	56	360	12	1.94	0.029
481000	1,000	100	10.0	66	440	6	1.58	0.029
482000	2,000	200	20.0	80	530	6	3.75	0.048

Minimum order quantity: 1.



Graduated measuring cylinders pentagonal base

Made of polypropylene. Autoclavable up to 121 °C.
In compliance with ISO 6706 standard.

POLYPROPYLENE								
code	capac. ml	grad. ml	subdiv. ml	O.D. Ø mm	height mm	case quantity	case weight	case volume
192562*	50	10	1.0	26	200	30	1.15	0.011
192563*	100	10	1.0	31	250	30	1.33	0.021
192564*	250	20	2.0	41	315	12	1.50	0.014
192565*	500	50	5.0	56	360	12	2.50	0.028
192566*	1,000	100	10.0	66	440	6	2.15	0.029
192567*	2,000	200	20.0	80	530	6	3.25	0.048

*Minimum order quantity: 1.

Made of TPX. Autoclavable up to 170 °C.
In compliance with ISO 6706 standard.

TPX								
code	capac. ml	grad. ml	subdiv. ml	O.D. Ø mm	height mm	case quantity	case weight	case volume
192572	50	10	1.0	26	200	30	1.15	0.011
192573	100	10	1.0	31	250	30	1.40	0.018
192574	250	20	2.0	41	315	12	1.45	0.014
192575*	500	50	0.5	56	360	12	2.45	0.028
192576*	1,000	100	10.0	66	440	6	2.15	0.030

*Minimum order quantity: 1.

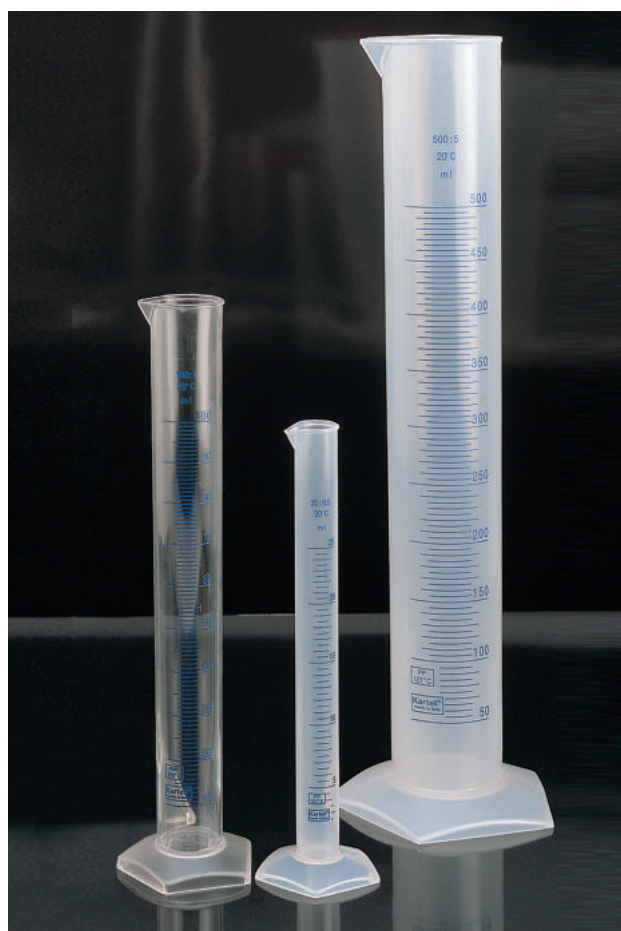

Volumetric flasks with stopper

Material: polypropylene. **Autoclavable up to 121 °C.**



NOTE: NS Neck:

The first measure regards to the inner Ø of the lower neck. The second one refers to the inner Ø of the upper neck.

code	capac. ml	height mm	Ø base mm	neck	case quantity	case weight	case volume
191484	25	132.5	36	12 / 21	20	0.24	0.002
191485	50	143.9	46	14 / 23	20	0.32	0.005
191486	100	173.8	58	14 / 23	20	0.39	0.012
191487	250	224	82	19 / 26	10	0.52	0.010
191488	500	264	100	19 / 26	10	0.60	0.018
191489	1,000	324	120	19 / 26	5	0.55	0.019

Minimum order quantity: 1.



Erlenmeyer flasks

Material: polypropylene. **Autoclavable up to 121 °C.** Graduated..

code	capac. ml	grad. ml	neck	quantity	weight	volume
191461	125	25	14.5 / 23	1	0.03	0.0006
191462	250	25	19 / 26	1	0.04	0.0001
191463	500	50	24 / 29	1	0.10	0.0002
191464	1,000	50	29 / 32	1	0.20	0.0002
191465	2,000	100	34.5 / 35	1	0.30	0.0004





Graduated beakers

Made of TPX. Autoclavable to 170 °C.
In compliance with ISO 7506 standard.



code	capac. ml	subdiv. ml	Ø mm	height mm	case quantity	case weight	case volume
191721	50	2	42	60	20	0.29	0.004
191722	100	5	52	72	12	0.70	0.004
191723	250	10	71	96	16	1.45	0.011
191724	500	10	90	120	12	2.10	0.015
191725	1,000	20	110	149	4	1.20	0.010
191726	2,000	50	135	184	4	2.00	0.018
191727	3,000	500	160	200	2	1.80	0.014

Minimum order quantity: 1.



Graduated beakers

Made of transparent polypropylene. Autoclavable a 121 °C.
In compliance with ISO 7506 standard.



code	capac. ml	subdiv. ml	Ø mm	height mm	case quantity	case weight	case volume
191822	50	2	42	60	20	0.31	0.004
191823	100	5	52	72	12	0.35	0.004
191824	250	10	71	96	16	0.75	0.010
191825	500	10	90	120	12	1.05	0.015
191826	1,000	20	110	149	4	0.50	0.010
191827	2,000	50	135	184	4	0.60	0.018
191828	3,000	500	160	200	2	0.90	0.014
191829	5,000	500	191	230	2	1.40	0.022



Graduated beakers

Material: transparent polypropylene. Autoclavable up to 121 °C.
In compliance with ISO 7506 standard.



code	capac. ml	Ø mm	height mm	case quantity	case weight	case volume
409050	50	42	60	20	0.29	0.004
409100	100	53	72	12	0.33	0.005
409250	250	71	96	16	0.72	0.011
409500	500	90	120	12	0.88	0.015
491000	1,000	110	149	4	0.49	0.009
492000	2,000	135	184	4	0.86	0.017
493000	3,000	160	200	2	0.88	0.022
495000	5,000	191	230	2	2.00	0.022

Beakers with three spouts

Graduated beakers made of ultra clear polypropylene **Autoclavable** up to 121 °C.
Disposable.

Moulded-in graduations.



code	volume ml	minimum order quantity	case quantity	case weight	case volume
490050	50	10	100	1.02	0.011
490100	100	25	100	1.38	0.011
490250	250	10	100	2.50	0.028
490400	400	10	100	3.30	0.044
490900	900	10	100	5.89	0.060



Conical measuring flasks

In polypropylene. **Autoclavable** up to 121 °C.



code	volume ml	height mm	case quantity	case weight	case volume
19423	250	160	1	1.14	0.019
19424	500	180	8	1.00	0.028
19425	1,000	270	3	0.81	0.016



Low form graduated beakers

Material: PFA.

High chemical and temperature resistance (–250 °C / 270 °C).

PFA main features:

This is a type of polyethylene where hydrogen atoms have been replaced by fluorine ones, commonly called «fluocarbons».

- Unbreakable, resistant to almost all temperatures
- Resistant to almost all chemical products, except fluorine and other alkaline metals during fusion
- Non flammable

Highly recommended for those cases where extreme conditions of transport and storage are required.



code	capacity ml	div. ml	height mm	Ø mm	quantity	weight	volume
191537	250	50 / 1	96	67	1	0.05	0.001





Analytical funnels

Material: polypropylene. **Autoclavable**. 60° angle.



code	Ø mm	stem Ø mm	length stem mm	total length mm	case quantity	case weight	case volume
19146	37	5	37	63.4	20	0.06	0.0019
19147	46	5	43	79	20	0.07	0.0036
19148	66	10	62	112	20	0.20	0.0110
19150	81	11	70	132	20	0.34	0.0135
19152	100	11	82	161.5	1	0.03	0.0007
19153	120	11	86	184	1	0.04	0.0038

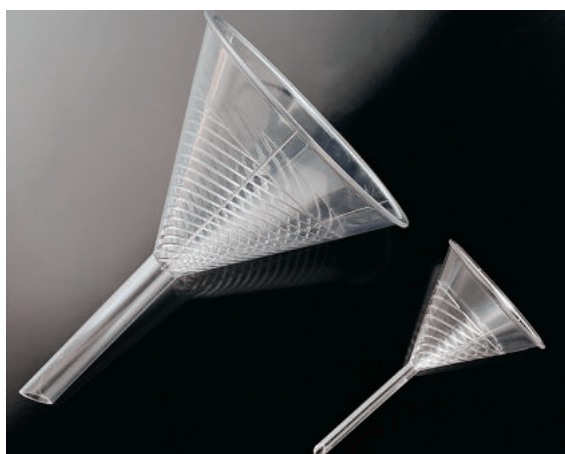

High speed funnels

Material: **TPX**. With interior helicoid channels for a quicker filtration. Prevents the filter paper from sticking. Transparent. **Autoclavable**.



code	Ø mm	stem Ø mm	length mm	case quantity	case weight	case volume
19175	51	3	150	6	0.12	0.0022
19172	70	3	150	6	0.19	0.0042
19173	100	7	108	4	0.26	0.0063
19174	140	10	132	6	0.96	0.0250



Long-stem funnels

Material: polypropylene. 60° angle. **Autoclavable**.



code	Ø mm	stem Ø mm	length stem mm	total length mm	case quantity	case weight	case volume
19164	80	8	143	206	10	0.20	0.017



Funnels

Material: polypropylene. **Autoclavable**.



code	external Ø mm	internal Ø mm	exit Ø (mm)	length (mm)	stem length (mm)	quantity	weight	volume
194171	80	75	5	83	30	1	0.03	0.0001
194172	100	90	8	100	35	1	0.03	0.0005
194173	120	110	9	115	40	1	0.04	0.0005
194175	180	175	12	170	60	1	0.09	0.0013
194176	220	210	17	205	75	1	0.17	0.0028
194177	260	250	21	245	85	1	0.29	0.0081
194178	300	290	24	285	105	1	0.37	0.0110

owder funnels

Material: polypropylene. **Autoclavable**. 60° angle.



code	Ø ext. mm	stem Ø mm	stem length mm	case quantity	case weight	case volume
19167	80	15	22.20	20	0.28	0.013
19168	100	25	24.80	20	0.57	0.011
19169	120	30	27.10	1	0.05	0.001
19166	180	40	48.80	1	0.09	0.009



«IMHOFF» sedimentation cone

Material: SAN. Moulded graduations according to DIN standards 12672.

Resistant to temperatures from **-20 °C to 85 °C**.

Graduation to 1, 2, 4, 6, 8, 10, 20, 30, 40, 60, 80, 100, 200, 300, 400, 500, 600, 700, 800, 900 et 1000 ml.



mod.	code	capac. mm	Ø mm	height mm	case quantity	case weight	case volume
1	191055	1,000	125	480	4	1.75	0.019



Rack for sedimentation cones

Material: PMMA.

For 2 cones. Resistant to temperatures from **-40 °C to 85 °C**.

mod.	code	dimensions mm	case quantity	case weight	case volume
2	191056	150 x 300 x 290	1	1.20	0.001

Büchner funnels

Material: polypropylene.

Unbreakable and resistant to corrosion and heat.

Easily dismantled for cleaning. **Autoclavable**.



code	capac. ml	filter Ø mm	upper Ø mm	bottom Ø mm	holes mm	case quantity	case weight	case volume
19438	70	55	16	11.8	1	1	0.05	0.007
19440	285	80	17.7	11.4	1.5	1	0.13	0.002
19441	390	90	18.1	14.4	2	1	0.20	0.003
19442	810	110	29.9	20.7	2	1	0.30	0.004
19443	2,100	160	29.5	22.8	2.5	1	0.60	0.012
19445	6,000	240	37.6	32.5	3	1	1.00	0.028





Burette clamps

Made of **autoclavable** polypropylene. Clamps can fit onto rods Ø 8 to 14 mm. Stainless steel centre arm includes a spring and firmly holds in place the burette by means of rubber pads. Burette clamps do not obscure graduations. Suitable for all burettes. Base is supplied separately.

mod.	code	description	case quantity	case weight	case volume
1	19139	for 1 burette	5	0.22	0.006
2	19140	for 2 burettes	5	0.32	0.013

Rectangular base for burettes

Base made of **autoclavable** polypropylene, with chromium plated steel rod. Rods can be screwed one onto the other to obtain different heights. All models come with 2 rods of Ø 250 x 12 mm. 2 models available: base with central hole, and base with off centre hole.

mod.	code	description	case quantity	case weight	case volume
3	19266	base with central hole and + 2 rods	1	0.75	0.001
4	19267	base with off-centre hole and + 2 rods	1	0.80	0.005

Rods available separately. Please contact our Commercial department.



Pipette stand

Made of polypropylene. Consists of a rounded base with a rod, and a circular pipette stand to hold up to 28 pipettes. Base and pipette stand are supplied separately.

- Code **19262**, rounded base with rod, is specially designed to hold the pipette stand.
- The stand code **19265** accomodates 18 pipettes Ø up to 10 mm, and 10 pipettes Ø up to 15 mm.

The lower disc has little holes for liquid draining. The ring included with the stand allows its raising and lowering on the rod.

 See chapter **Microbiology**

code	description	case quantity	case weight	case volume
19262	rounded base	1	0.24	0.002
19265	18 small and 10 large holes stand	1	0.35	0.007



Rotary pipette stand

This stand which can hold 94 pipettes consists of 2 discs rotating on a central vertical axis for convenient pipette selection. The lower rotating disc has tapered sides and open bottoms to protect tips and allow water run off. Rotating discs are 18 cm diameter.

The pipette stand comes unassembled with instructions for quick and easy assembly.

Made of **autoclavable** polypropylene.

Can accomodate all our serology pipettes presented on page 41 and 204, except the 25 ml model.

code	dimensions mm (Ø x h)	case quantity	case weight	case volume
19254	230 x 480	1	0.39	0.005

Flask weight ring

Heavy vinyl covered ring ideal to improve stability of Erlenmeyer flasks in water bath. High chemical resistance.

code	erlenmeyer capacity	internal Ø mm	quantity	weight	volume
192470	125 - 500 ml	48	1	0.32	0.0003
192471	250 - 1,000 ml	51	1	0.59	0.0010
192472	500 - 2,000 ml	57	1	0.64	0.0004



Vacuum pump

Material: polypropylene. This vacuum pump combines excellent suction capacity with limited water consumption, under low pressure (0.5-1 kg/cm²) as well as high pressure (10 kg/cm²). The built-in, non return valve protects the pump from possible water back-flow. **Autoclavable.**

Can be dismantled for easy cleaning.



code	description	quantity	weight	volume
191395	water jet vacuum pump	1	0.03	0.00001

Minimum order quantity: 1.



Pipette and burette rinsing set

Made of polyethylene and polypropylene. Can hold pipettes and burettes of length up to 60 cm. Ensures a fast, safe washing.

Ideal for use in labs where caustic and toxic materials are used.

Suggested sets:

For pipettes	1 x 19217 2 x 19219 1 x 19218
For shorter pipettes	1 x 19217 1 x 19221
For burettes	1 x 19215 2 x 19219 2 x 19218 1 x 19218

code	description	height mm	Ø mm	case quantity	case weight	case volume
19215	burette washer	990	165	1	3.50	0.11000
19217*	pipette washer	734	165	1	3.35	0.08000
19218	pipette jar	650	165	1	1.80	0.04200
19219	pipette basket	650	130	2	2.00	0.02600
19221	pipette jar	500	165	1	1.50	0.03000

* Code 19217 requires a 13mm inner diameter tube. It is not included.



Drying rack

Wall mountable high impact white polystyrene drying rack for general labware. This rack consists of a single mould 4 mm plate with 72 peg sockets.

Push-in pegs can be placed in any configuration on the rack, and are easily removable to accommodate odd shaped items.

Peg sockets have closed ends to avoid dripping and eliminate the risk of biological contamination.

Rack suitable for items with diameter of the mouth larger than 15 mm.

A **drip channel** collects dripping that drains via a drain tube provided. Includes 11 additional peg sockets (Ø 6 mm) for smaller parts.

Comes complete with a mounting kit and fixing template.

Peg sockets Length: 100 mm

code	dimensions mm	case quantity	case weight	case volume
19213	450 x 630 x 110	1	4.00	0.045



Drying rack

PVC coated steel wire drying rack for general labware.

It embodies 55 pegs, and 5 brackets specially designed to hold erlenmeyer flasks and beakers. Pegs are plastic coated for better protection.

Two rings on the rack allow the rack to be mounted on the wall.

It includes a tray in order to avoid drops on the surfaces where the rack is placed.

Peg sockets Length: 90 mm

code	dimensions mm	case quantity	case weight	case volume
19212	640 x 360 x 140	1	2.12	0.130



Laboratory spatulas

Material: polystyrene.

code	description	length mm	bag quantity	bag weight	bag volume
19593	spatula-spoon	210	10	0.008	0.0005
19596	spatula-spoon	180	10	0.008	0.0005



Measuring scoops

Material: white polypropylene. **Autoclavable.**
Made with materials suitable for alimentary use.



code	capacity ml	alimentary use	length mm	bag quantity	bag weight	bag volume
191057	10	✓	100	12	0.06	0.0004
191058	25	✓	135	12	0.10	0.0016
191059	50	✓	160	12	0.16	0.0045
191060	100	✓	200	12	0.29	0.0054
191062	250	✓	260	6	0.27	0.0076
191063	500	✓	315	6	0.46	0.0130
191064	1,000	✓	400	6	0.73	0.0150



Measuring scoops

Material: high density polyethylene.
Made with materials suitable for alimentary use.



code	capacity ml	alimentary use	length mm	bag quantity	bag weight	bag volume
191065	25	✓	135	12	0.08	0.0014
191066	65	✓	185	12	0.20	0.0011
191067	110	✓	215	12	0.35	0.0036
191068	150	✓	250	12	0.42	0.0040
191070	350	✓	310	6	0.39	0.0050
191071	750	✓	350	6	0.69	0.0190
191069	1,250	✓	400	6	0.99	0.0115



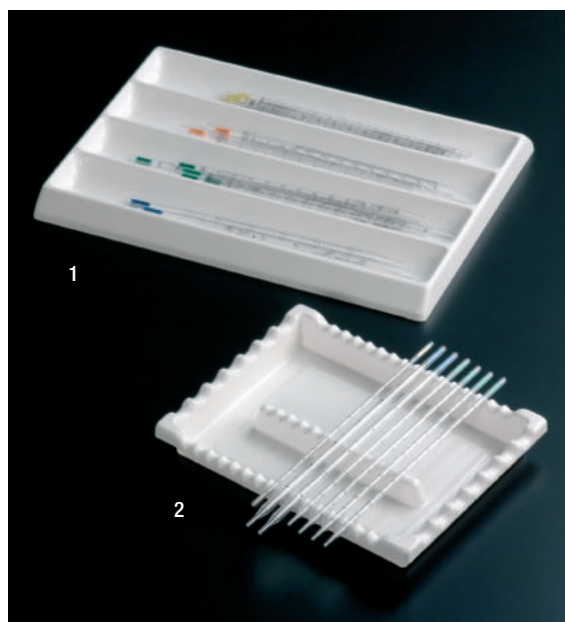

PVC Pipette tray

Made of white PVC, resistant to temperatures from $-20\text{ }^{\circ}\text{C}$ to $80\text{ }^{\circ}\text{C}$. **Model 1**, code **19252**, is perfect to fit inside drawers. It includes four compartments that can hold up to thirty pipettes of 1, 2, 5, or 10 ml.

Model 2, code **19996**. Sixteen pipettes up to 10 mm diameter can be accommodated longitudinally; laterally, seven pipettes up to 20 mm diameter.

Tray edges are ergonomically designed for a better handling. It is also useful with other instruments.



See our range of pipettes on pages 41 and 204.

mod.	code	dimensions mm	case quantity	case weight	case volume
1	19252	426 x 300 x 30	1	0.53	0.006
2	19996	283 x 216 x 40	6	1.38	0.017



PVC Antiacid trays

Resistant to temperatures from $-20\text{ }^{\circ}\text{C}$ to $80\text{ }^{\circ}\text{C}$. Ideal for photographic purposes thanks to their ribbed interior surface.

code	int. dimensions mm	ext. dimensions mm	quantity	weight	volume
19280	200 x 150 x 45	245 x 195 x 50	1	0.15	0.0007
19281	250 x 200 x 60	305 x 250 x 60	1	0.24	0.0012
19282	320 x 260 x 70	385 x 325 x 75	1	0.47	0.0021
19283	350 x 300 x 80	420 x 375 x 85	1	0.52	0.0026
19284	430 x 330 x 90	505 x 405 x 95	1	0.79	0.0043
19285	520 x 420 x 90	600 x 495 x 100	1	1.15	0.0080



ABS trays

They withstand temperatures from $-40\text{ }^{\circ}\text{C}$ to $85\text{ }^{\circ}\text{C}$.

code	int. dimensions mm	ext. dimensions mm	body weight g	quantity	weight	volume
195703	320 x 220 x 10	353 x 252 x 21	217	20	5.72	0.014
195705	150 x 100 x 30	201 x 151 x 41	91	20	1.88	0.007
195706	260 x 110 x 30	303 x 151 x 42	134	20	2.76	0.008
195707	310 x 210 x 30	353 x 253 x 41	254	20	6.00	0.019
195709	140 x 90 x 70	202 x 151 x 81	110	20	2.36	0.008
195711	290 x 190 x 70	352 x 252 x 81	299	20	6.64	0.023
195713	380 x 270 x 10	408 x 300 x 21	345	10	3.50	0.014

Hexagonal weighing dishes

Made of white translucent polystyrene. Easily bent into pouring spouts, the dishes enable non-spill transfer. Biologically inert, contaminant-free, they are resistant to diluted acids, aqueous solutions, alcohols and bases.

Antistatic. Suitable for microwave.

Will withstand temperatures from **80 °C** to **-10 °C**.

code	capacity ml	upper Ø (a) x lower Ø (b)	case quantity	case weight	case volume
1911106	9	35 x 25	500	0.28	0.001
1911107	50	64 x 47	500	1.00	0.004
1911108	200	110 x 85	500	2.30	0.007

For other measures, consult with the commercial team.

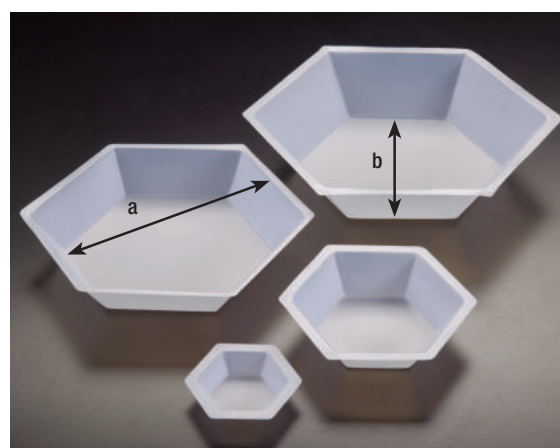

Squared weighing dishes

Made of white translucent polystyrene.

Easily bent into pouring spouts, the dishes enable non-spill transfer. Biologically inert, contaminant-free, they are resistant to diluted acids, aqueous solutions, alcohols and bases. **Not antistatic.** Suitable for microwave.

Will withstand temperatures from **80 °C** to **-10 °C**.

Made with materials that comply with FDA regulations concerning plastic materials in contact with food (styrene waste under 21 CFR 177.1640).

code	dimensions	weight g	bag quantity	bag weight	bag volume
1911103	41 x 41 x 8	0.34	500	0.32	0.001
1911104	89 x 89 x 25	1.07	500	1.39	0.005
1911105	140 x 140 x 22	3.27	500	3.47	0.013



Rhomboid weighing dishes

Polystyrene flexible weighing dishes with a smooth surfaces to provide accurate pour-outs with minimal sample loss. Biologically inert, contaminant-free, they are resistant to diluted acids, aqueous solutions, alcohols and bases.

Wide, flat bottom to resist tipping.

Antistatic.

Suitable for microwave. Will withstand temperatures from **70°C** to **-10°C**.

code	capacity ml	colour	dimensions	bag quantity	bag weight	bag volume
1911110	5	white	55 x 35 x 6	500	0.200	0.0010
1911111	30	white	78 x 56 x 14	500	0.520	0.0028
1911112	100	white	119 x 90 x 19	500	1.340	0.0082
1911114	30	black	78 x 56 x 14	500	0.500	0.0025

For other measures, consult with the commercial team.



Watch glasses

Made of **autoclavable** polypropylene. Moulded base for more stability.

Easy **cleaning**.



code	weight g	Ø mm	case quantity	case weight	case volume
19454	5.5	80	10	0.06	0.002
19455	10	100	10	0.10	0.002



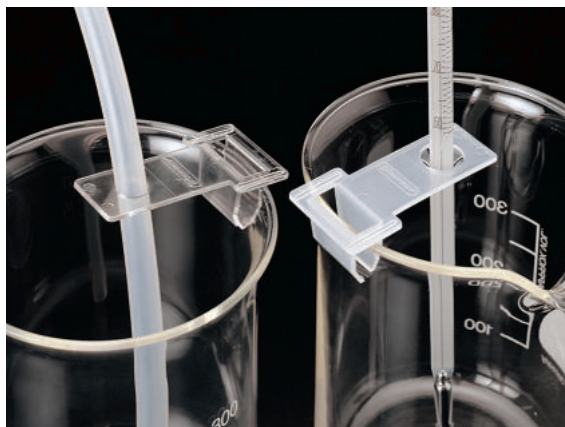

Laboratory holders

Ideal for holding tubing or thermometers onto the edge of beakers or other vessels. **Autoclavable.**



code	description	bag quantity	bag weight	bag volume
19971	for tubing of up to 9.5 mm Ø Polycarbonate	6 x 6	0.13	0.0013
19972	for thermometers from 3.2 mm to 11 mm Ø Polypropylene	12 x 3	0.17	0.0018

Minimum order quantity: 19971 - 6 units 19972 - 3 units



Tubing clamps

Material: **autoclavable** acetal.
These clamps will not distort, rust or corrode.
Different positions to control flow from full open to complete closure.



code	description	bag quantity	bag weight	bag volume
19505	for tubes of 3.2 to 11 mm (15 positions)	12	0.09	0.0005
19504	for tubes of 11 to 19 mm (12 positions)	6	0.11	0.0007

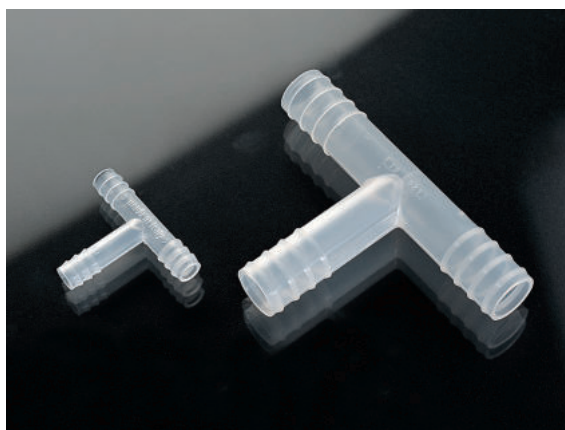

«T» connectors

Material: polypropylene. **Autoclavable.**



code	fits tubing Ø mm	Ø mm* valley/crest	Ø mm int. mouth	shape	bag quantity	bag weight	bag volume
19460	6	4.5 / 5.4	2.8	T	20	0.01	0.0002
19461	8	6.9 / 7.6	4.4	T	20	0.23	0.0002
19462	10	8.7 / 9.5	6.3	T	20	0.54	0.0010

* See the scheme



«Y» and «+» connectors

Material: polypropylene. **Autoclavable.**



code	fits tubing Ø mm	Ø mm* valley/crest	Ø mm int. mouth	shape	bag quantity	bag weight	bag volume
19465	6	4.7 / 5.7	2.7	Y	20	0.12	0.00018
19467	10	8.9 / 9.9	5.5	Y	20	0.03	0.00002
19468	12	10.5 / 11.6	7.3	Y	20	0.09	0.00003

* See the scheme

Silicone tubing. Non toxic

For use in a variety of medical, pharmaceutical, industrial and clinical applications. Translucent tubing. Very high mechanical and chemical resistance. Silicone tubing has a chemical composition similar to quartz and glass and share their excellent properties.

Autoclavable. Made with materials suitable for alimentary use.

Technical features:

Specific gravity: 1.2 + 0.1. Toughness: 40 - 80 Sh.

Resistance to traction: 77-95 kg/cm². Extension: 275-780%

Resistance to tearing: 20-50 kg/cm². Temperature range: **-50 °C to 200 °C** (beaks of **250 °C**). Pressure range: up to 1.5 bar

code	dimensions mm Ø int. x Ø ext.	bag quantity (meters)	bag weight	bag volume
350051	0.5 x 1	1 x 100	0.08	0.0011
350013	1 x 3	1 x 15	0.12	0.0010
350024	2 x 4	1 x 15	0.23	0.0016
350034	3 x 4	1 x 15	0.22	0.0043
350035	3 x 5	1 x 15	0.26	0.0026
350037	3 x 7	1 x 15	0.51	0.0032
350046	4 x 6	1 x 15	0.56	0.0026
350048	4 x 8	1 x 15	0.80	0.0043
350057	5 x 7	1 x 15	0.38	0.0039
350059	5 x 9	1 x 15	0.83	0.0047
350069	6 x 9	1 x 15	0.61	0.0100
350610	6 x 10	1 x 15	0.83	0.0096
350612	6 x 12	1 x 15	0.22	0.0043
350079	7 x 9	1 x 15	0.63	0.0091
350710	7 x 10	1 x 15	0.70	0.0076
350810	8 x 10	1 x 15	0.67	0.0091
350812	8 x 12	1 x 15	1.11	0.0054
350814	8 x 14	1 x 15	1.87	0.0008
350912	9 x 12	1 x 15	0.82	0.0120
350915	9 x 15	1 x 15	0.22	0.0043
351014	10 x 14	1 x 15	1.43	0.0081
351420	14 x 20	1 x 15	2.72	0.0240
351622	16 x 22	1 x 15	4.15	0.0320
352030	20 x 30	1 x 15	7.00	0.0490

NOTE: Tube thickness = $\frac{\text{external } \varnothing - \text{internal } \varnothing}{2}$

Silicone sheets

50 x 50 cm silicone sheets ideal as a laboratory benchtop protection or for use in autoclaves to protect any material.

For cleaning simply use a wet cloth.

Resistant up to 230 °C.



code	thickness mm	bag quantity	bag weight	bag volume
350002	2	1	0.60	0.030
350004	4	1	1.20	0.001

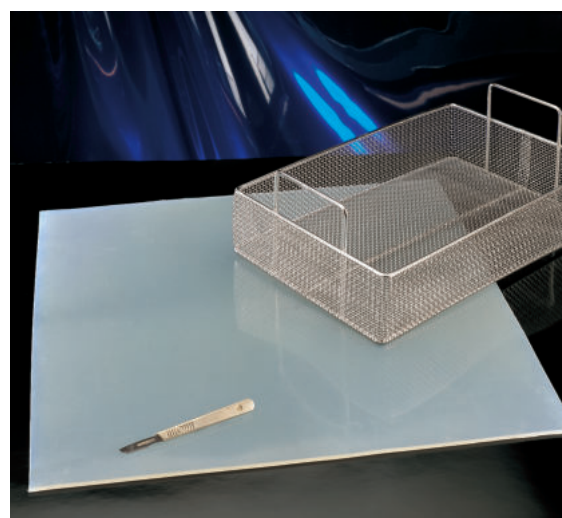



«Straight» and 3 way connectors

Material: polypropylene. **Autoclavable.** Made of one piece.

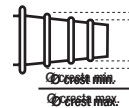

code	fits tubing Ø mm	Ø mm* valley/crest	Ø mm int. mouth	bag quantity	bag weight	bag volume
19510	4-5-6	5.5 / 4.5 / 3	2.0	20	0.16	0.00002
19512	9-8-10	11 / 9 / 6.3	4.5	20	0.06	0.00030
19513	10-11-12	13 / 10.5 / 8.3	6.5	20	0.74	0.00100

* See the scheme



Composed Disconnectors / connectors

Material: polyethylene. Very useful for connecting rubber or plastic tubing of different diameter. Composed by two parts. Connectors fit tightly together.

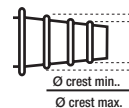

code	fits tubing Ø mm	Ø mm crest max/min	Ø mm int. mouth	bag quantity	bag weight	bag volume
19435	06-07-08	7.6 / 5.3	2.7	20	0.62	0.0010
19535	10-11-12	12.2 / 9.3	5.5	20	1.06	0.0010



Non-return valve

Material: polypropylene.

Autoclavable.

Maximum work pressure: 2 bar (2 kg/cm²).

Minimum work pressure: 0,07 bar, at 20 °C.

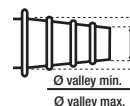

code	Ø ext valves	Ø mm valley max/min	bag quantity	bag weight	bag volume
19418	8-9-10	10.1 / 7.8	10	0.04	0.0002



Flow indicator (1)

Material: SAN. Perfectly transparent.

The rotation of the red ball allows an immediate visual indication of glass or liquid flow. Very useful for connecting tubes of different diameter from 6.5 to 10 mm.

code	dimensions mm	tubing mm	bag quantity	bag weight	bag volume
19538	102 x 14 x 57	6.5-10	5	0.07	0.0002

Flow indicator (2)

Material: SAN.

Not for use with corrosive fluids or temperatures over 85 °C.

code	dimensions mm	tubing mm	bag quantity	bag weight	bag volume
19539	90 x 15 x 40	6-11	5	0.08	0.0004

Cylindrical or octahedral stirring bar assortment pack

Assorted cylindrical or octahedral stirring bars supplied in a convenient transparent plastic box including dividers for magnet classification.

Box includes 2 units of the following stirring bars:

Code 19400: (diameter x length in mm): 8x13, 8x15, 10x25, 10x38, 10x51 and 10x64.

Code 19400.1: (diameter x length in mm) 6x10, 4,5x15, 6x20, 6x25, 6x30, 8x40, 8x50, 10x60, 10x70.

code	description	quantity	weight	volume
19400	box with 12 octahedrals stirring bars	1	0.25	0.0006
19400.1	box with 18 cylindrical stirrings bars	1	0.25	0.0006



One-hand timer

60 Minute times model "Onehand" non-slip surface.

Can be rewound with one hand only.

code	description	Ø x h mm	quantity	weight	volume
19901	one-hand timer	72.5 x 29.5	1	0.24	0.0003



Digital timers

Digital timer with hours, days and months, 24 h. programme facility, 60 seconds, alarm, includes clip and small bench stand.

These digital timer count forward and down. Both include a LR44 battery.

Code **900400** includes instructions in English and German an code **900600** includes instructions in Spanish, English and French.

mod.	code	description	dimensions mm	quantity	weight	volume
1	900600	digital timer with 2 memories	64 x 61 x 14	1	0.08	0.0003
2	900400	digital timer with 1 memory	52 x 67 x 12	1	0.06	0.0003



Magnetic stirring bars

This section details our vast range of PTFE magnetic stirring bars. A variety of different sizes and colours is available.

- **Micro stirring bars:** for use in the smallest containers.
- **Cylindrical stirring bars:** these are the most common and lend themselves to many general applications. The diameter of the bar chosen will depend on the diameter of the flask used although it is recommended to select the largest stirring bar possible to achieve optimum results.
- **Octagonal stirring bars with pivot ring:** ideal where the base of the container may be slightly curved or irregular.
- **Triangular stirring bars:** these are used primarily to help dissolve solids or sediments. Also used for higher viscous liquids.
- **Ovoid stirring bars:** used in rounded bottom or Erlenmeyer flasks.
- **Special shape stirring bars:** cruciform stirring bars are used in round bottom tubes.



Stirring bar retriever

Polypropylene coated.

For the removal of stirrer magnets from vessels of all kinds.

Includes a magnetic tip, so it is easy to remove the magnets.

code	Ø mm	length mm	bag quantity	bag weight	bag volume
19919	10	300	1	0.04	0.00002



Micro stirring bars

For use in the smallest containers.

code	Ø mm	length mm	quantity	weight	volume
19852	2	5	1	0.04	0.0001
19855	3	8	1	0.04	0.0001
19856	3	10	1	0.04	0.0001

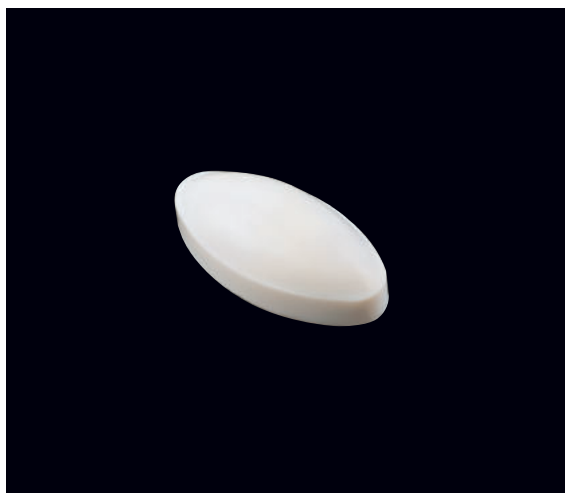

Ovoid stirring bars

Used in rounded bottom or Erlenmeyer flasks.

code	dimensions mm	quantity	weight	volume
19806	50 x 20	1	0.004	0.0002

Octahedral stirring bars with pivot ring

Ideal where the base of the container may be slightly curved or irregular.

code	Ø mm	length mm	quantity	weight	volume
19786	8	15	1	0.04	0.0001
19810	8	22	1	0.06	0.0001
19787	8	25	1	0.06	0.0001
19793	8	28	1	0.06	0.0001
19788	8	38	1	0.06	0.0001
19797	10	51	1	0.08	0.0001
19811	13	75	1	0.08	0.0001



Cylindrical stirring bars

code	Ø mm	length mm	quantity	weight	volume
19753	3	6	1	0.04	0.0001
19748	3	8	1	0.04	0.0001
19750	4.5	12	1	0.04	0.0001
19751	6	15	1	0.04	0.0001
19756	8	20	1	0.06	0.0001
19757	8	25	1	0.06	0.0001
19758	8	30	1	0.06	0.0001
19763	6	35	1	0.06	0.0001
19764	8	40	1	0.06	0.0001
19698	8	50	1	0.06	0.0001
19705	10	70	1	0.08	0.0001

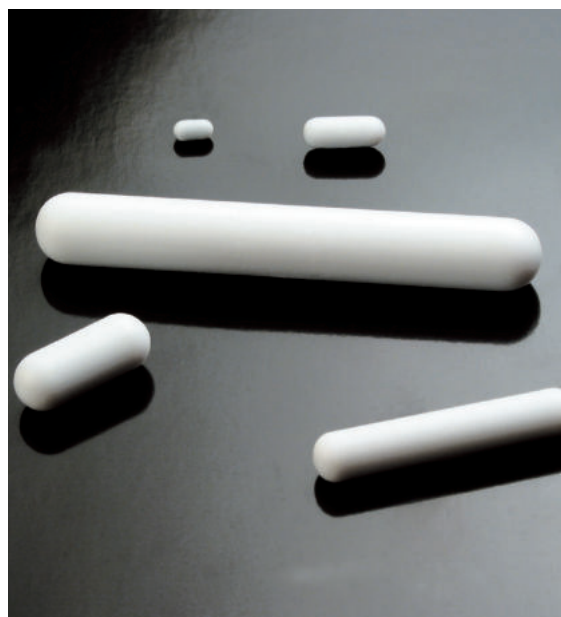

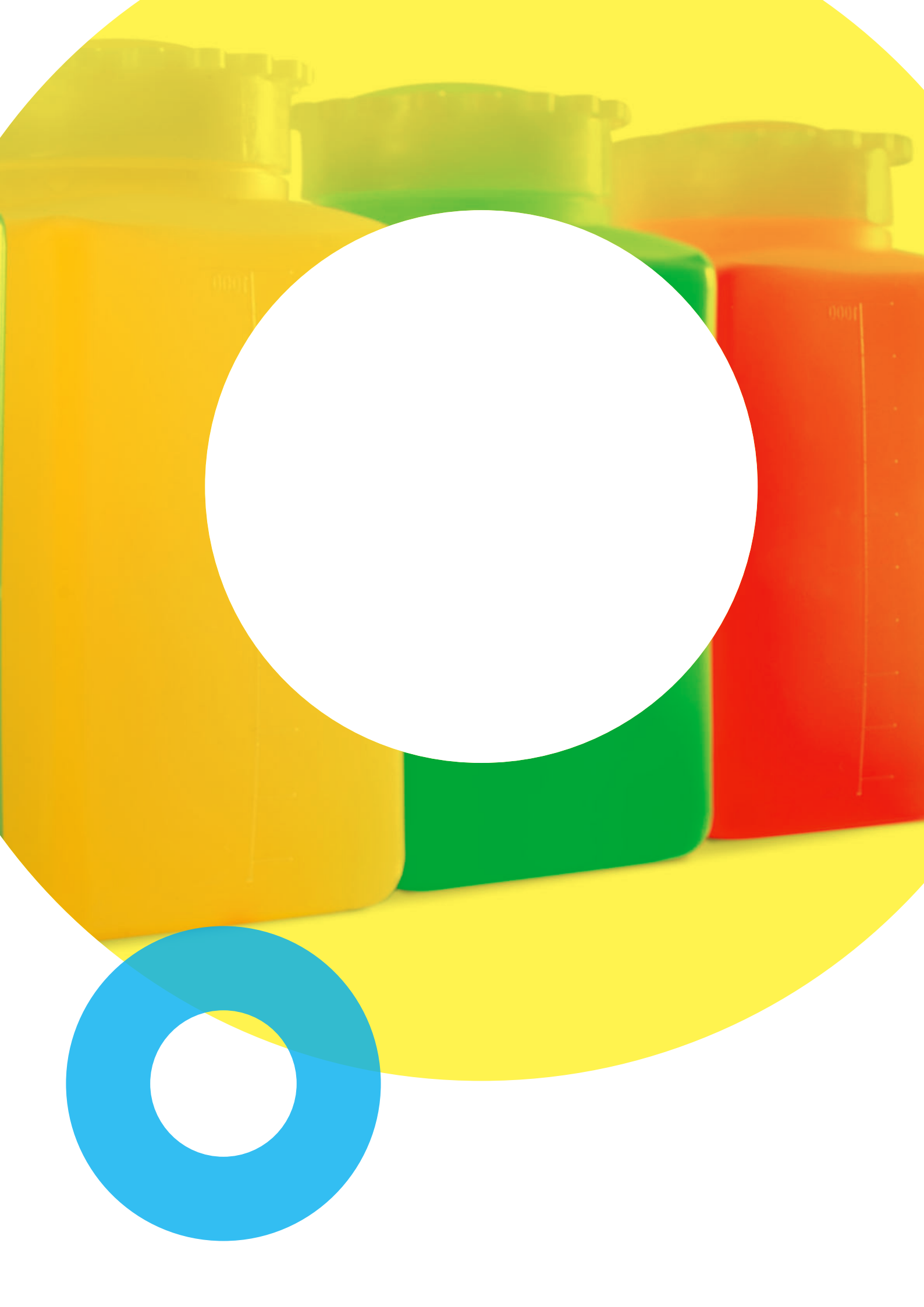



**LABORATORY
AND INDUSTRIAL
PACKAGING**

 **deltalab**



Polyethylene wide mouth jars with lid and insert plug

High density polyethylene jars with screw cap and insert plug.

Jars and plugs are natural translucent colour; lids are black. Supplied uncapped (except sterile models, supplied capped and bagged).

Upon request, jars can be supplied individually wrapped for a minimum order of 3 cases by model, and sterile for a minimum order of 6 cases by model.

Ask for minimum quantity and delivery time for caps and jars in other colours.

code	capacity ml	sterile, individual wrap	no sterile, individual wrap	Ø internal mouth mm	Ø body mm	unitary weight g	height with lid mm	alimentary use	case quantity	case weight	case volume	pallet quantity
202811	30	—	—	25	32	4.2	53		100	1.00	0.011	14,700
202810	60	—	—	38	52	8.2	48		200	3.90	0.046	8,000
202808	90	—	—	51	60	8	51	✓	150	3.15	0.045	4,800
202809	125	—	—	51	60	12	62	✓	200	6.00	0.082	4,000
202801	170	—	—	51	60	14	80		160	6.46	0.082	3,200
202802	250	—	—	54	67	20	100	✓	125	4.85	0.080	2,500
202802.1	250	yes	yes	54	67	20	100		125	4.94	0.084	2,500
202802B	250	—	yes	54	67	20	100		125	5.50	0.078	2,500
202814	400	—	—	60	74	27.3	124		130	8.00	0.140	1,560
202814.1	400	yes	yes	60	74	27.3	124		130	8.00	0.140	1,560
202803	500	No	No	67	80	35	131	✓	120	7.70	0.140	1,920



code	capacity ml	sterile, individual wrap	no sterile, individual wrap	Ø internal mouth mm	Ø body mm	unitary weight g	height with lid mm	alimentary use	case quantity	case weight	case volume	pallet quantity
202823.1	500	yes	yes	67	80	35	131		120	7.60	0.140	1,920
202821.1	500	—	yes	86	103	44.9	93		95	8.31	0.140	1,520
202821	500	—	—	86	103	44.9	93	✓	95	8.44	0.140	1,520
202821.0	500	yes	yes	86	103	44.9	93		95	9.20	0.140	1,520
202823	500	—	yes	67	80	35	131		120	8.60	0.130	1,920
202813	750	—	—	86	103	48	127	✓	75	4.56	0.152	900
202813.10	750	yes	yes	86	103	48	127		75	7.20	0.140	1,200
202818	1,000	—	—	86	103	56.7	157	✓	50	5.43	0.140	800
202828G	1,000	yes	yes	86	103	56.7	157		50	5.66	0.140	800
202828	1,000	—	yes	86	103	56.7	157		50	5.66	0.140	800
202804	1,250	—	—	86	103	56.7	173	✓	50	6.10	0.140	800
202815	1,550	—	—	86	113	64.6	181		45	6.00	0.140	720
202815B.0	1,550	yes	yes	86	113	64.6	181		45	6.00	0.140	720
202820	2,000	—	—	86	103	83.1	283	✓	35	5.12	0.140	560
202820.0	2,000	yes	yes	86	103	83.1	283		35	6.10	0.140	560
202839*	2,000	—	—	105	128	73	205		32	5.14	0.140	512

* This model is supplied with lid.



Polyethylene beakers

Volumes available range from 60 ml to 1,000 ml.

All models come without lid, except the 1,000 ml beaker, which is available with or without lid.

For use with liquid and solid samples. Manufactured in a flexible material for easy pouring.

code	volume ml	body Ø mm	mouth Ø mm	height mm	weight body g	case quantity	case weight	case volume
242801	60	40	50	48	5.0	1,100	5.95	0.034
242802	100	40	55	58	7.0	1,000	7.20	0.034
242803	230	55	70	78	15.5	700	10.82	0.042
242804	275	53	72	98	22.0	500	11.66	0.042
242805	500	70	90	108	35.2	200	8.50	0.045
242806	1,000	90	120	132	65.0	120	8.22	0.042
242811*	1,000	90	120	132	65.0	65	5.93	0.042

* With lid, Beaker and lid are supplied in the same bag,



Disposable cups

Disposable sample cups, for general sample collection.

Cups are supplied stacked.



code	volume ml	material	mouth Ø x height	case quantity	case weight	case volume
202248	100	polypropylene	57.5 x 62	40 x 100	5.53	0.070
202317	150	polystyrene	70 x 70	30 x 100	8.32	0.080

Tamper evident buckets, large capacity

Disposable containers made of **autoclavable polypropylene**. Include tight fitting and leakproof lids. All models include a sturdy and convenient white plastic handle for easier carrying. Buckets are supplied with lid apart. **Made with materials suitable for alimentary use.**

code	capacity l	Ø ext. lid mm	Ø int. mouth mm	height whitout lid mm	*body weight g	case quantity	case weight	case volume
222802	3	200	184.00	138.00	105.00	80	9.00	0.140
222803	4.5	225	210.00	156.00	134.00	48	10.46	0.140
222804	5.6	225	211.00	194.00	152.00	45	10.79	0.140
222805	10.6	268	251.00	263.00	314.00	20	8.39	0.140

* Weight with no lid.



Jars with lid

Body and lid in white **autoclavable polypropylene**.

Self sealing security lid.

Code **241014** and **241015** embodies a plastic handle.

Jars are supplied uncapped.

Cases per pallet: 24, excepting code **241010**, palletized in 40 cases.

Made with materials suitable for alimentary use.



code	nominal cap. ml	Ø int. mouth x Ø base x h without lid mm	*weight g	case quantity	case weight	case volume
241010	250	84 x 79 x 61	13	150	3.04	0.042
241011	550	107 x 98 x 79	24	250	5.01	0.103
241013	1,000	107 x 94 x 144	36	150	7.31	0.082
241014	1,560	135 x 118 x 138	48	150	10.12	0.130
241015	2,000	163 x 144 x 156	75	48	5.37	0.075

* Weight with no lid.



Buckets with spout

Natural **low density polyethylene** buckets with a stainless metal handle. Include a spout for easier pouring.
Moulded-in graduations. Very sturdy construction.
These buckets may be printed with your name and logo.

code	capacity l	dimensions mm	quantity	weight	volume
19905	9	270 x 200 x 250	1	0.58	0.014
19906	12	300 x 220 x 280	1	0.70	0.018
19907	15	340 x 250 x 310	1	0.85	0.026



Industrial jugs

Made of thick **rigid polypropylene**. Natural colour.
Recommended for industrial use.
Made with materials suitable for alimentary use.



code	capacity l	mouth Ø mm	height mm	weight ut. g	case quantity	case weight	case volume
470007	5	190	240	400	5	1.86	0.030



Round jugs with handle

Polypropylene. **Autoclavable to 121 °C**. Moulded-in graduations
Made with materials suitable for alimentary use.



code	capacity l	graduation ml	Ø mm	height mm	case quantity	case weight	case volume
470000	0.5	25	80	120	60	4.40	0.066
470001	1	50	125	140	48	4.60	0.086
470002	2	50	155	180	36	6.40	0.110
470003	3	100	165	180	27	7.10	0.130
470005	5	250	185	230	12	5.00	0.106

Minimum order quantity: 1.

Self sealing security jars

Excellently finished, body in **autoclavable polypropylene**. Screw cap in high density polyethylene with strips. Security sealing with tag for easy opening. Tamper evident system. External moulded ring. Smooth internal side. Each jar specifies on its bottom its capacity, and the material it is made of. Supplied uncapped. **Made with materials suitable for alimentary use.**

code	volume ml	max. body Ø mm	base Ø mm	height Ø mm	lid external Ø mm	weight ut. without lid g	case quantity	case weight	case volume
202911N	100	55.8	50.0	59.1	56.0	15.0	150	3.40	0.042
202912N	250	71.8	65.0	83.4	72.0	23.3	115	4.80	0.082
202913N	350	94	87.7	68.0	96.0	27.0	80	3.64	0.082
202914N	500	94	87.7	105.3	96.0	36.0	100	6.15	0.140
202915N	1,000	111.6	110.8	123.8	111.8	62.0	60	7.13	0.140
202916N	1,250	111.6	110.8	153.0	111.8	73.0	45	5.32	0.140



Square containers with star-shaped caps

Colour: translucent white. Containers and insert plugs made of **polyethylene**. Star-shaped screw caps made of polypropylene. Tagging points on neck and cap for a tamper proof closure or for labeling. All models have moulded-in graduations. Containers are supplied plugged and capped. Not recommended for liquids transport.

Made with materials suitable for alimentary use.

code	capacity ml	graduation each ml	dimensions mm	neck Ø mm	body weight g	case quantity	case weight	case volume	pallet quantity
444608	25	12.5	32 x 34 x 52	18	6	500	6.60	0.090	12,000
444609	50	10	38 x 38 x 70	23	15	400	7.50	0.074	9,600
444610	100	20	42 x 48 x 90	33	22	600	18.20	0.195	9,600
444611	250	50	57 x 60 x 110	33	32	300	13.80	0.195	4,800
444612	500	100	70 x 80 x 138	44	55	150	10.50	0.192	2,400
444613	1,000	100	80 x 103 x 176	58	97	80	11.16	0.173	1,280
444614	2,000	100	100 x 134 x 210	58	177	40	9.16	0.170	640





Bottles with standard, narrow neck

Bottles made of **autoclavable**, natural colour **polypropylene**. Hermetical closure. Easy opening and closing caps thanks to its size. Grippled, in order to ease its usage with gloves. Cap and body with holes for sealing or labeling.

Neck and cap with vents.

Graduation: 100 ml model, every 20 ml; 250 ml, every 25 ml; 500 ml and 1,000 ml, every 100 ml.



code	volume ml	neck DIN	mouth Ø mm	body Ø mm	height mm	body weight g	case quantity	case weight	case volume
191597	100	GL18	13	48	106	18.5	100	1.82	0.032
191601	500	GL25	19	75	180	49.3	150	9.00	0.180
191603	1,000	GL32	23	95	222	100.9	80	8.80	0.180



Bottles with standard, wide neck

Wide neck bottles made of **autoclavable polypropylene**, or **polyethylene** (not autoclavable).

Body and caps in natural colour. Hermetical closure.

Easy opening and closing caps thanks to its size. Grippled, in order to ease its usage with gloves.

Neck and cap with vents. Graduation: 100 ml model, every 20 ml; 250 ml, every 25 ml; 500 ml, 1,000 ml, and 2,000 ml, every 100 ml.



Made of polyethylene, not autoclavable:

code	volume ml	neck DIN	mouth Ø mm	body Ø mm	height mm	body weight g	case quantity	case weight	case volume
191610	100	GL32	24	48	103	25.7	100	2.78	0.036
191612	250	GL45	38	60	140	39.2	5 x 50	2.06	0.180
191614	500	GL45	38	75	168	55.9	5 x 25	9.30	0.180
191616	1,000	GL63	55	95	206	109.3	68	9.30	0.180
191618	2,000	GL63	55	120	249	145.2	30	6.30	0.180



Made of polypropylene, autoclavable:

code	volume ml	neck DIN	mouth Ø mm	body Ø mm	height mm	body weight g	case quantity	case weight	case volume
191623	100	GL32	24	48	103	26.6	100	2.98	0.038
191625	250	GL45	38	60	140	40.8	250	12.40	0.180
191627	500	GL45	38	75	168	56.5	125	8.50	0.180
191629	1,000	GL63	55	95	206	100.2	68	8.84	0.180
191631	2,000	GL63	55	120	249	175.5	30	6.30	0.180

Wide neck containers with star-shaped cap

Made of **high density polyethylene**. Natural colour.

Cylindrical container featuring a star-shaped screw cap.

Tagging points on neck and cap for a tamper proof closure, or for labeling. Containers are supplied non capped.

Made with materials suitable for alimentary use.

code	volume ml	internal mouth Ø mm	body Ø mm	height without lid mm	body weight g	case quantity	case weight	case volume	pallet quantity
44430000	125	29.5	52	103.5	18	100	3.00	0.045	4,000
44440000	250	37	65	128	24	120	5.20	0.080	2,880
44450000	500	47.4	82	152	40	60	4.32	0.080	1,440
44460000	1.000	59.4	102	183.2	90	55	7.49	0.140	880
44470000	2.000	59.4	123.5	244.5	128	30	5.75	0.140	480



Wide neck graduated containers with star-shaped cap

Colour: translucent white.

Bottles and insert plugs made of **high density polyethylene**.

Star-shaped screw caps made of polypropylene.

Tagging points on neck and cap for a tamper proof closure.

Sloping shoulders for easy pouring.

Bottles are supplied plugged and capped.



code	volume ml	graduation ml	internal mouth Ø mm	body Ø mm	height mm	body weight g	case quantity	case weight	case volume	pallet quantity
19408	50	10	24	40	75	13.20	100	1.65	0.019	9,600
19409	100	20	24	50	90	18.30	100	2.37	0.027	8,400
19410	250	25	34	60	125	35.80	50	2.16	0.037	3,600
19411	500	50	34	75	160	50.70	20	1.20	0.024	1,120
19412	1,000	100	45	95	200	92.20	20	1.95	0.046	960





Graduated narrow neck bottles

Made of translucent **polyethylene**.
 Designed for the storage of acids and bases. Include a ribbed screw cap for a better handling, and an insert plug.
 Feature sloping shoulders for easy pouring.
 Tagging points on neck and cap for a tamper proof closure and for labeling.
 Bottles have the following moulded-in graduations: code **19317**, every 10 ml; **19319**, every 20 ml; **19323**, every 25 ml, **19324**, every 50 ml, **19325** and **19326**, every 100 ml.
 Supplied capped.



code	volume ml	neck Ø mm	bottom Ø mm	height mm	case quantity	case weight	case volume
19319	125	18.5	46	107	6 x 100	15.48	0.151
19323	250	23	60	131	6 x 50	12.78	0.151
19324	500	23	74	157	6 x 25	9.00	0.195
19325	1,000	33	94	205	4 x 20	9.00	0.187
19326	2,000	33	112	266	2 x 20	8.40	0.151



Graduated narrow neck opaque bottles

Opaque cylindrical bottles made of **dark grey polyethylene**, designed for the storage of light sensitive liquids or solid substances. Include a black screw cap and an insert plug for a positive leakproof seal.
 Ribbed caps for a better handling.
 Heavy duty bottles, with sloping shoulders for easy pouring.
 Tagging points on neck and cap for a tamper proof closure.
 Body and cap with holes for sealing or labeling.
 Supplied capped.

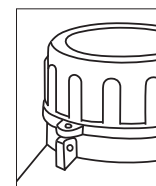

code	volume ml	neck Ø mm	bottom Ø mm	height uncapped mm	case quantity	case weight	case volume
193241	500	23	75	157	6 x 25	9.00	0.195
193251	1,000	33	95	208	4 x 20	9.70	0.192

Minimum order quantity: 1 bag.



Narrow neck, high resistance bottles

Bottles made of translucent, white, **high density polyethylene**, designed for the storage of acids and bases.
 Blue screw cap on a combination of high and low density polyethylene. Screw caps are ribbed for a better handling.
 Sloping shoulders for easy pouring. Heavy duty bottles.
 Supplied uncapped.



See page 251



code	volume ml	neck Ø mm	bottom Ø mm	height mm	case quantity	case weight	case volume
44260000	250	30	67	157	90	4.90	0.076
44270000	500	30	79	176	70	4.86	0.076
44280000	1,000	30	96	211	50	6.70	0.110

Tamper evident, polyethylene bottles

Translucent cylindrical bottles made of **high density polyethylene with PP screw cap** and LDPE insert plug, designed for the storage of alcohol.

Caps are ribbed for a better handling while working with gloves. Insert plugs are dispensed pierced. Tamper evident cap.

No graduation. Supplied uncapped.

code	capac. ml	int. neck Ø mm	bottom Ø mm	height mm	body weight g	case quantity	case weight	case volume	pallet quantity
292300	75	19	39.4	97.6	8	220	2.92	0.042	6,160
292303	125	19	45	106	10	140	2.44	0.043	5,600
292304	250	19	58	128	18	80	2.10	0.044	3,200
292305	500	19	73	160	31	100	4.30	0.107	1,200
292306	1,000	19	82	230	46	60	5.00	0.110	720



Tamper evident bottles, tall models

Translucent cylindrical bottles made of natural colour **low density polyethylene**, with blue tamper evident closures.

Caps are ribbed for a better handling while working with gloves.

Bottles specially designed with tamper evident rings to ensure a positive seal.

Bottles are supplied uncapped.

To fully seal them, screw cap in a normal way and then screw again to fully position the tamper evident ring.

To open, unscrew cap. The ring, automatically broken, will remain on the neck of the bottle.

code	capac. ml	body Ø mm	neck Ø mm	height mm	body weight g	case quantity	case weight	case volume	pallet quantity
282303	125	48	37	105	16.2	125	2.96	0.045	5,000
282304	250	59	37	129	21.9	75	2.48	0.045	3,000
282305	500	66	37	200	35.0	100	4.98	0.100	1,600
282306	1,000	87	37	230	52.0	60	4.22	0.140	960



Screw cap containers with seal and dropper

Made of **white polypropylene**.

White watertight screw closing system with dropper-plug and blue security seal.

Hermetical closure. Mouth diameter: 10.2 mm.

Supplied uncapped.

code	volume ml	Ø base mm	height mm	body weight g	case quantity	case weight	case volume	pallet quantity
53020	20	24.6	65	3.50	2,000	12.70	0.122	32,000
53125	125	42.2	134.7	15.50	275	5.88	0.114	4,400
53250	250	50.8	167.3	21.50	200	5.95	0.100	3,200



Rectangular bottles

Body and cap made of **polyethylene**.

Bottles with blue screw caps, including seal ring and internal joint.

Tamper evident system.

Body in natural colour, graduated (moulded):

250 ml model, graduated each 50 ml.

500 and 1,000 ml models, graduated each 100 ml.

Supplied uncapped.

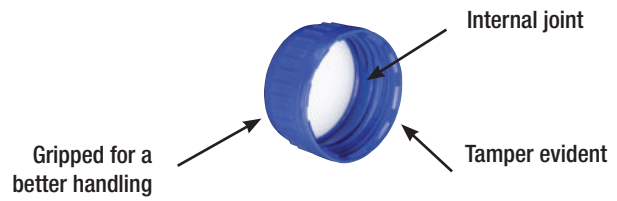

code	volume ml	internal mouth Ø mm	dimensions (A x B x C) mm	weight g	case quantity	case weight	case volume	pallet quantity
292819G	250	30.3	58 x 58 x 115	21	175	5.90	0.096	3,360
292820G	500	30.3	77 x 77 x 130	35	153	9.70	0.140	2,448
292821G	1,000	30.3	96 x 75 x 184	62	82	6.41	0.140	1,360



Nozzle bottles

Cylindrical bottles with screw caps, made of **high density polyethylene**, with a narrow nozzle design. Natural colour.

Cut the nozzle tip with scissors before liquid dispensing.

No graduation.

Bottles and caps are supplied in separated bags.

code	volume ml	neck Ø mm	bottom Ø mm	height mm	case quantity	case weight	case volume
272301	50	20	35	75	160	2.10	0.027
272303	125	20	48	100	135	2.52	0.045
272304	250	20	59	143	75	2.24	0.047

Squared bottles

Bottles with screw cap and insert plug, made of **polyethylene**.
 Bottles and insert plugs are white (translucent), caps are red.
 Ribbed caps for a better handling when using gloves.
 Supplied capped.

code	volume ml	mouth Ø mm	dimensions mm	weight g	case quantity	case weight	case volume	pallet quantity
292819	250	37	58 x 58 x 103	21	210	6.00	0.096	3,360
292820	500	50.5	77 x 77 x 116	35	165	8.18	0.140	2,640
292821	1,000	50.5	96 x 75 x 172	62	96	7.55	0.140	1,536



Polyethylene bottles

Rectangular body and cap made of **polyethylene**.
 The smaller sides are gripped for a better handling.
 The bigger sides are flat for labelling.
 Self-sealing blue cap with internal security ring.
 Hermetical closure. Tamper evident system.
 Supplied uncapped.



See sterile models on chapter **Microbiology**



code	volume ml	dimensions mm	int. mouth Ø mm	body weight g	case quantity	case weight	case volume	pallet quantity
282310	500	83 x 65 x 135	28	40	123	5.53	0.11	2,460
282311	1,000	83 x 65 x 235	28	61	73	4.93	0.11	1,460





Drum with screen and childproof cap

Made of white colour **high density polyethylene**.

They embody a handle and a graduated screen which allows the user to see the content.

Childproof, tamper evident, ribbed screw cap with insert plug (see how to use a childproof cap in page 133).

Drums are supplied non screwed.

Dimensions: 133,8 x 192,5 x 391 mm

Made with materials suitable for alimentary use.

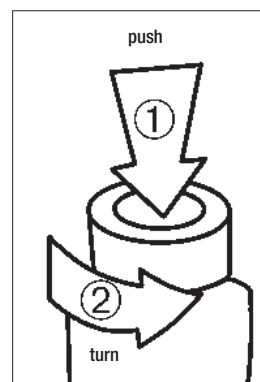

code	capacity l	total cap. ml	Ø int. mouth mm	body weight g	case quantity	case weight	case volume	pallet quantity
202505	5	5,260	34.5	170	16	3.25	0.14	256



Cylinder with handle

Made of **polypropylene**. **Autoclavable at 121 °C**.

The handle provides a secure, solid grip for superior control, specially when handling large volumes.

Pouring is safer and more convenient, as the cylinder is specially designed to ensure a total liquid delivering. 89 x 29 mm hand opening for easy handling.

Hexagonal base to prevent tipping and rolling.

Accurate and easy to read graduated double scale on the cylinder.

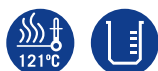

code	volume l	graduation ml	height mm	bottom Ø mm	Ø cylinder int. mm	Ø cylinder ext. mm	quantity	weight	volume
191578	1	10	440	146	59	64	1	0.62	0.020
191579	2	20	490	161	81	87	1	0.56	0.020

Stackable drums with tamper evident caps

Made of natural colour **high density polyethylene**. They embody a **handle** and a **tamper evident**, ribbed screw red **cap**, made of HDPE, with internal joint and internal security ring.

Hermetical closure when the cap is totally screwed.

ONU ADR compliant. Drums and caps are supplied non screwed.

code	capacity l	total capacity ml	minimum wall thickness mm	dimensions mm	quantity	weight	volume	pallet quantity
206020	20	20,900	1.20	242 x 298 x 365	1	1.00	0.023	48
206025	25	25,550	1.20	242 x 298 x 443	1	1.14	0.028	48



Wide mouth drums with security cap

Body made of natural colour and translucent **polyethylene**.

Cap made of blue polyethylene. Cap with seal and internal joint.

It incorporates a black plastic handle.

Suitable for solids and semi-solids.



code	capacity l	Ø external body mm	Ø internal mouth mm	height mm	quantity	weight	volume	pallet quantity
202705	5	168	97	288	11	3.65	0.133	176
202710	10	210	97	353	6	3.24	0.134	96



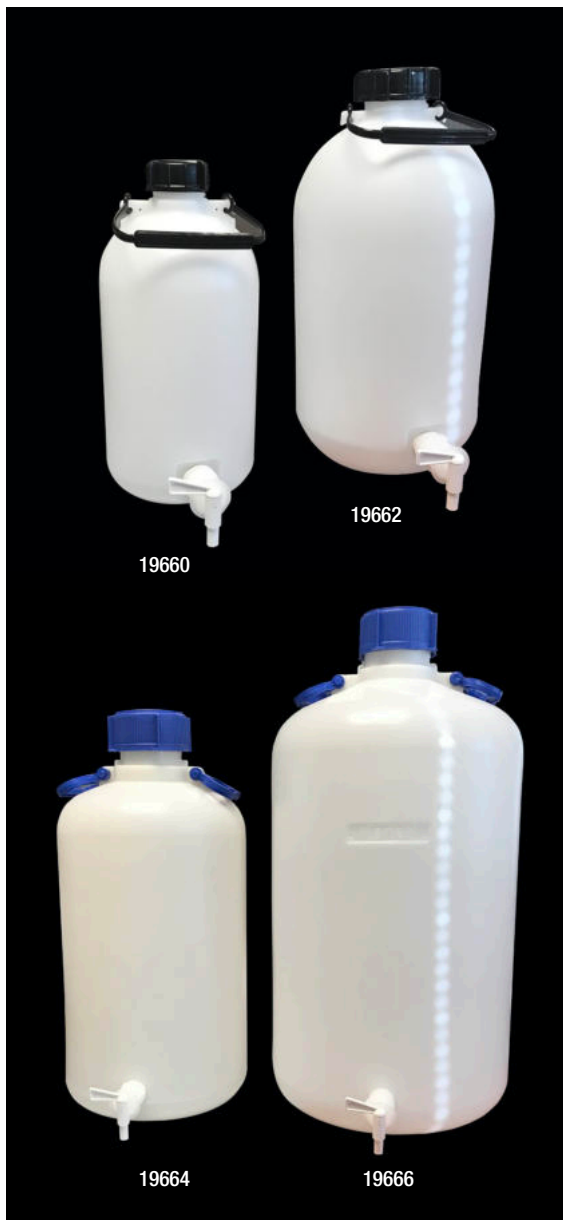

Drums with tap

Made of **high density polyethylene**. (Code **19375** is made of polypropylene). Heavy duty drums, wall thickness 2 mm. With two handles for easy transport. Can be used at temperatures below 0 °C.

The tap includes a seal ring to ensure a leakproof seal. Drums are supplied complete with tap (also available spare tap).

Each drum includes a screw cap and a plug for added security. **Be sure to tighten the drums' thread firmly.**

The codes **19660** and **19662** are made with materials suitable for alimentary use.



code	capacity l	Ø neck mm	Ø base mm	height mm	quantity	alimentary use	weight	volume
19660	5	52.5	165	345	1	✓	0.85	0.019
19662	10	52.5	210	425	1	✓	0.50	0.016
19664*	25	79.5	280	565	4		5.76	0.17
19666*	50	79.5	350	700	2		4.80	0.17

Spare tap:

19375	-	-	-	-	1		0.005	0.0001
-------	---	---	---	---	---	--	-------	--------

*Minimum order quantity: 1.

Wide and narrow neck drums

Heavy duty drums made of **high density polyethylene**.

Include an insert plug for a positive leakproof seal, and one handle for easy carrying. Tagging points on neck and cap for a tamper proof closure or for labelling.

Wide mouth drums are designed both for solids and powders, easy to fill and pour. **Made with materials suitable for alimentary use.**



Wide neck bottles (1)

code	capacity l	Ø neck mm	Ø body mm	height mm	quantity	weight	volume	pallet quantity
191640	5	90	165	305	1	0.43	0.009	200
191642	10	120	210	395	1	0.90	0.014	90



Narrow neck bottles (2)

code	capacity l	Ø neck mm	Ø body mm	height mm	quantity	weight	volume	pallet quantity
191646	10	53	210	420	1	0.85	0.015	90



Stackable drum with tamper evident screw cap

Made of **high density polyethylene**.

It is provided with a sealing screw cap with grip.

This drum has four flat sides suitable for sticking information labels.

They are distinguished by two main characteristics: they can be easily stacked joining the tops and the bottoms together, and they can be palletised thanks to their reduced overall dimensions.

All of them are **ONU ADR** compliant, meeting all the standards for the transport of hazardous, toxic and noxious products.

Made with materials suitable for alimentary use.

code	nominal capacity l	total capacity l	dimensions mm	Ø mouth mm	DIN	quantity	weight	volume	pallet quantity
202605	5	5.5	198 x 148 x 240	44	51	1	0.27	0.007	200
202610	10	11.6	224 x 193 x 305	44	51	1	0.47	0.017	100
202620	20	21.7	245 x 295 x 375	44	51	1	0.90	0.027	48
202625	25	26.9	245 x 295 x 435	44	51	1	1.10	0.031	48
202630	30	34.5	332 x 290 x 428	49	61	1	1.26	0.036	36



Wide mouth storage drums with tap and plug

Body and cap made of **polyethylene**. Screw cap with non hermetical plug. Using Teflon at thread tap is recommended to ensure a complete sealing. They embody a tap, and two black folding handles at the top. Not designed to transport liquids. External mouth diameter: 150 mm.

code	capacity l	Ø base mm	height mm	quantity	weight kg	volume
209030	30	355	457	1	1.51	0.059
209050	50	355	675	1	2.35	0.084



Large deep trays

Made of natural **high density polyethylene**. Stackable. Include ergonomically designed handles.



code	dimensions mm	height mm	tray volume l	quantity	weight kg	volume
19603	550 x 430	310	50	1	1.76	0.069
19604	630 x 440	340	65	1	3.00	0.090
19605	720 x 470	360	90	1	4.50	0.120



Funnels

Material: **polypropylene**. Autoclavable.



code	stem int. Ø mm	stem ext. Ø mm	bouche mm	quantity	weight	volume
194172	9.1	11.7	100	1	0.03	0.0005
194175	13.9	18.2	180	1	0.09	0.0013
194176	18.5	21.8	220	1	0.17	0.0028
194177	21.7	26.4	260	1	0.29	0.0081
194178	24.7	29.7	300	1	0.37	0.0110

Industrial drums

These drums are produced in **high density polyethylene**. Their particular top, which has a **perfectly stiffened rim obtained** during the moulding phase, prevents the opening from becoming deformed and the lid from becoming detached as a consequence of any drops or violent shocks.

They feature a metal washer that ensures a perfect closure where is also suitable to place a tamper evident seal.

Thanks to their **airtight seal**, they are **suitable for transport by sea, road or railway** and, thanks to their construction characteristics and qualities; they **fully meet the current ONU ADR standards for transport of hazardous products**.

Incinerable (excluding the metal closure).

These drums are produced using selected top-quality raw materials, they feature excellent drop-impact resistance even at low temperature (-20 °C) and stability against corrosion from chemical agents which may cause stress cracking.

Their **internal surface is perfectly smooth**, and this makes it easy to fully empty and completely clean the inside from any powder, paste or semi-dense products. All references have two handles for easy carrying except code **208128**.

Made with materials suitable for alimentary use.

code	capacity l	external body Ø mm	external mouth Ø mm	internal mouth Ø mm	height mm	alimentary use	quantity	weight kg	volume	pallet quantity
CYLINDRICAL DRUMS										
208030	30	320	252	255	502	✓	1	2.50	0.08	48
208060	60	405	327	400	610	✓	1	3.02	0.15	27
208128	120	480	400	390	800	✓	1	5.48	0.30	18
RECTANGULAR DRUMS										
208031	30	285	275	235	52	✓	1	1.89	0.033	100
208061	60	360	445	423	62	✓	1	2.99	0.078	48



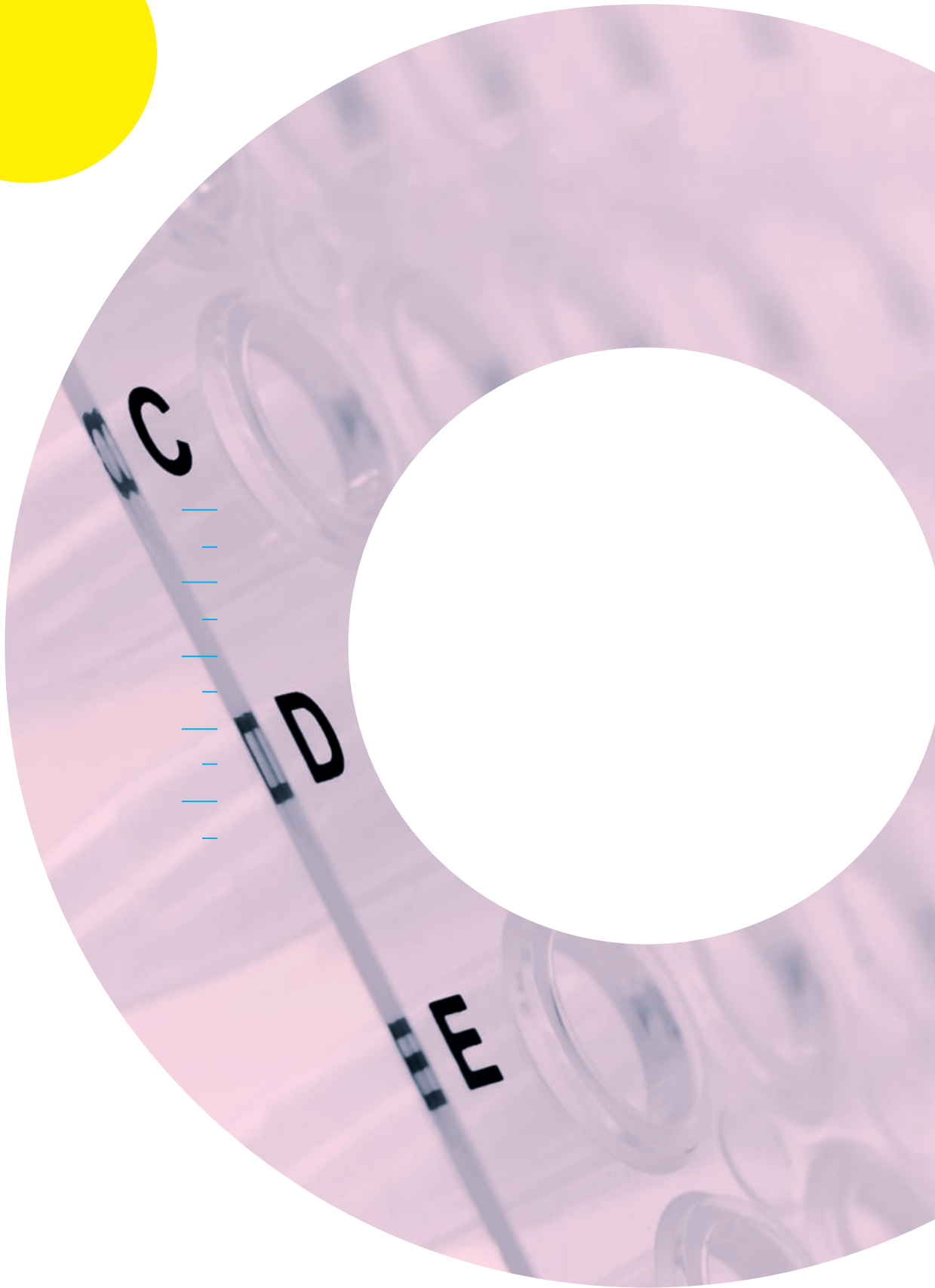
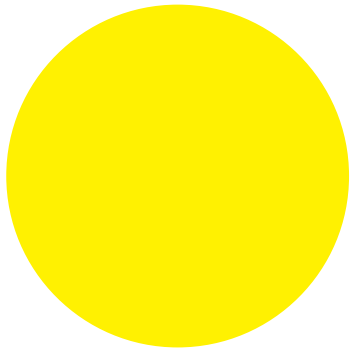

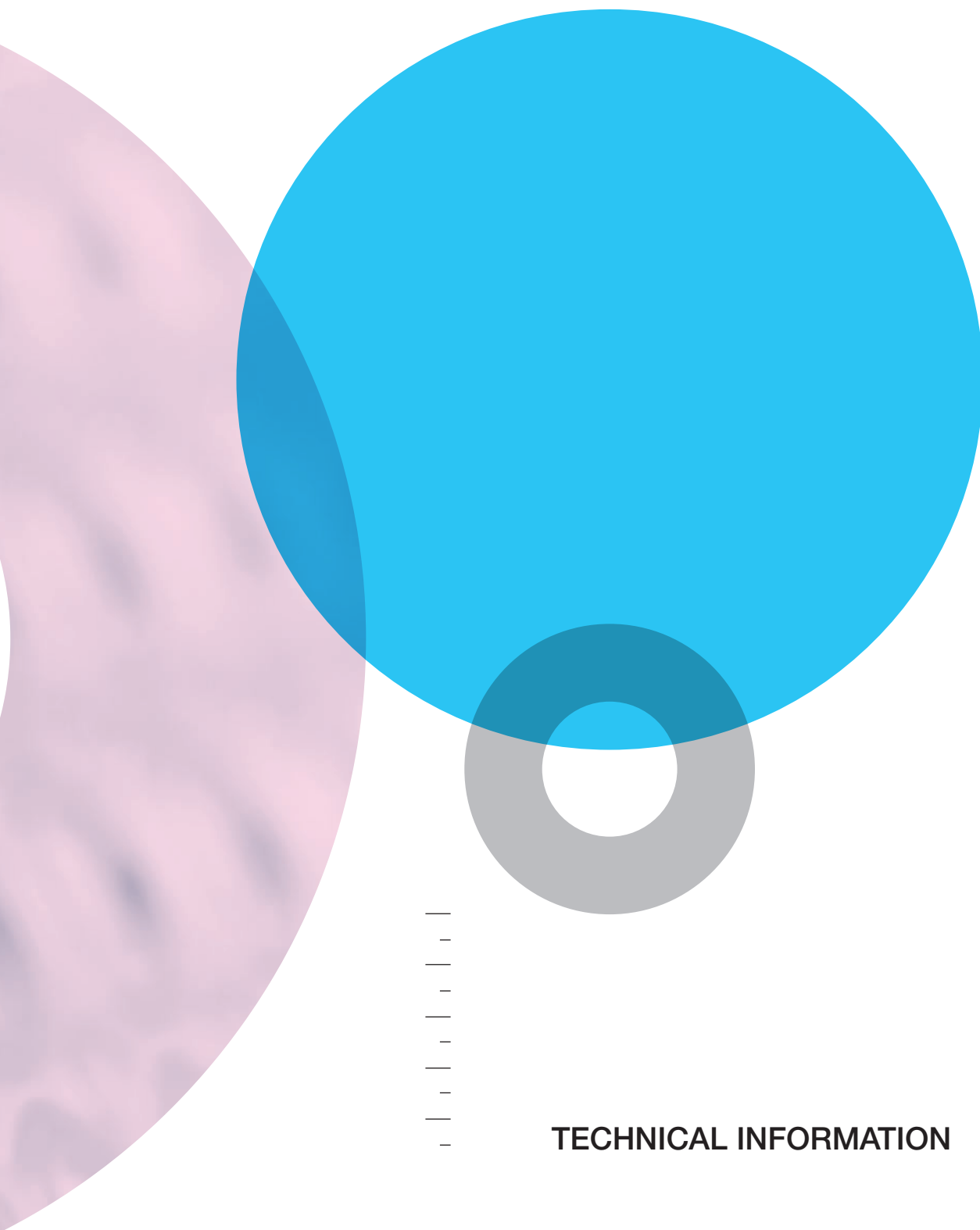

TECHNICAL INFORMATION

 **deltalab**

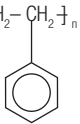
	POLYSTYRENE	POLYETHYLENE HIGH DENSITY	POLYETHYLENE LOW DENSITY	POLYPROPYLENE
GENERAL PROPERTIES	PS Crystal (GPPS)	PEHD	PELD	PP Homopolymer
Structure	Amorphous structure $\text{[-CH}_2\text{-CH}_2\text{-]}_n$ 	Structure with few ramifications, greater compaction $\text{[-CH}_2\text{-CH}_2\text{-]}_n$	Very branched chain structure, greater flexibility $\text{[-CH}_2\text{-CH}_2\text{-]}_n$	Partially crystalline $\text{[-CH}_2\text{-CH-]}_n$ CH_3
Optical properties	TRANSPARENT	TRANSLUCENT	TRANSLUCENT	TRANSLUCENT
Mechanical resistance	Rigid and hard but fragile Low impact resistance	Rigid Very good impact resistance	Less stiffness and toughness than PEHD Good impact resistance	Rigid
Density	1.04 - 1.05 g/cm ³	0.924 - 0.980 g/cm ³	0.918 - 0.927 g/cm ³	0.898 - 0.950 g/cm ³
Max. temperature	70° C	80° C	75° C	121° C
Min. temperature	-10° C	-50° C	-50° C	0° C*
Autoclavable	NO	NO	NO	YES
Gas sterilization	DOSES LIMITED	YES	YES	YES
Gamma irradiation Sterilization	YES	YES	YES	DOSES LIMITED
Beta irradiation Sterilization	YES	YES	YES	DOSES LIMITED
Water absorption	0.098 - 0.11 %	0.010 - 0.011 %	0.010 - 0.011 %	0.010 - 0.10 %
Properties	- Insulator, low electrical conductivity - Sparkly	- Excellent thermal and chemical resistance - Easily charges static electricity	- Good thermal and chemical resistance - Easily charges static electricity	- Resists better high temperatures - Great resistance to stress cracking - Lightweight

*There are special blends of PP like those from our cryovials, which are able to withstand up to -196 °C.

	POLYSTYRENE	HIGH DENSITY POLYETHYLENE	LOW DENSITY POLYETHYLENE	POLYPROPYLENE
GENERAL CHEMICAL RESISTANCE	PS	PEHD	PELD	PP STANDAR
Oils	LIMITED	LIMITED	LOW	GOOD
Acids	LIMITED*	GOOD	GOOD*	GOOD*
Alcohol	GOOD	GOOD*	GOOD	GOOD
Bases	GOOD	GOOD	GOOD	GOOD
Ketones	NULL	LIMITED	LIMITED	LIMITED
Esters	LOW	LIMITED	LIMITED	LIMITED
Fats	GOOD	GOOD	GOOD	GOOD
Hydrocarbons -aromatics	NULL	LIMITED	LOW	LOW
Hydrocarbons Chloride	See**	LIMITED	LIMITED	See**
Hydrocarbons Halogenated	NULL	LOW	NULL	LOW
Metals (Cu, Mn, Co)	See**	See**	See**	LIMITED
Oxidants	NULL	LOW	LOW	LOW

* LOW for certain acids and depending on the concentration.

** The chemical resistance of plastics is detailed in the specific table of resistance according to the different chemical compounds.

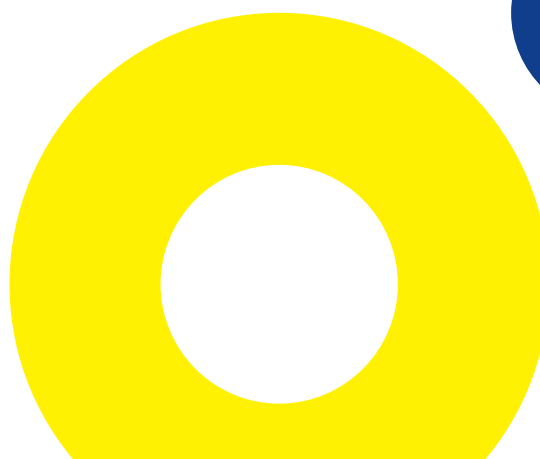
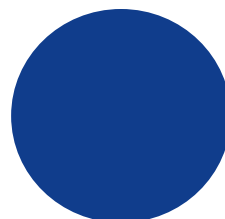

STERILISATION METHODS

METHOD	Dry heat	Autoclave, Super Heated Steam under pressure	Ethylene Oxide ("EO Gas")
PROCEDURE	Direct action of dry heat. For example: 171 for 60', 160 for 120' or 140 for 180'.	Action of 3 elements: temperature, water steam and pressure 121 °C (20') (+1 atm)	Exposure of the material to the gas for a time that can reach up to 8h, at a temperature between 40°C and 50°C and with a relative humidity between 50% and 60%.
RECOMMENDED FOR	Glassware, metals and liquids.	Glassware, fabrics, liquids etc. All materials resistant to heat above 121°C and moisture.	All materials with some exceptions. It is often used when materials to be sterilized are sensitive to steam or radiation.
PRECAUTIONS	High temperatures may damage fragile metals.	It is not recommended for some types of plastic. In the case of closed containers, the caps must not be adjusted (steam must be allowed to enter and exit easily).	Requires a subsequent ventilation to ensure sterilised products are free of residual gases that may be toxic.
LIMITATIONS	The own material's limitations. High heat soaking may unacceptably affect material properties.	Generally for low volume products.	Ethylene oxide is toxic and explosive.

STERILE A STERILIZATION TYPE: in this case the parts are not sterilized at the end of its manufacture process since is the process by itself which is able to obtain a sterile product. This is because the entire process from injection of different plastic components to the assembly is protected by a sterile atmosphere, thanks to the cowl of the entire installation and the placement of laminar flows that create an overpressure sterile air inside the facilities.

CENTRIFUGATION

Conversion G y R.P.M.

The **relative centrifugal force (RCF)** can be determined using the formula:

$$FCR = 1.118 \times 10^{-6} \times r \times n^2$$

r= radius of the rotor (mm); distance between the axis of the rotor and the farthest wall of the tube.

n= rotating speed (revolutions per minute).

The result is expressed in terms of acceleration (g); 1 g is equal to 9.807 m/s².

It is recommended that the centrifuge caps fit in size and shape to the tubes to be centrifuged.

CONVERSION (°F - °C - °K)

°F (Fahrenheit) = (°C x 1.8) + 32	°C (Celsius) = (°F - 32) x 0.556	°K (Kelvin) = °C + 273.15
-----------------------------------	----------------------------------	---------------------------

STERILISATION METHODS

By ionizing radiation (gamma rays)	By ionizing radiation (beta rays)	METHOD
Photons emitted by the radioisotope Co-60.	High energy electrons generated in a particle accelerator.	PROCEDURE
Widely used in industries to sterilise single use material. Sterilisation doses are calculated from bioburden counts.	Widely used in industries to sterilise single use material. Sterilisation doses are calculated from bioburden counts.	RECOMMENDED FOR
Limitations in some applications, as some material properties may be unacceptably altered by this method.	Limitations in some applications, as some material properties may be unacceptably altered by this method.	PRECAUTIONS
The effects are cumulative, so the material that has been sterilized by this method cannot be re-sterilized by many other conventional methods (eg ethylene oxide), after its initial use.	The electron beam has limited penetration power, so the density of the product to be sterilized must be taken into account. The effects are cumulative, so the material that has been sterilized by this method cannot be re-sterilized by many other conventional methods (eg ethylene oxide), after its initial use.	LIMITATIONS

The sterilization indicator labels are small round stickers that change their color when the material is properly sterilized:

Radiation: from yellow to red.

Ethylene oxide: from violet to green.

CONVERSION CHART XG - R.P.M.

r \ xg	1,000 xg	1,500 xg	2,000 xg	2,500 xg	3,000 xg	3,500 xg	4,000 xg	4,500 xg	5,000 xg	10,000 xg	15,000 xg
50 mm	rpm 4,227	5,177	5,978	6,683	7,321	7,908	8,454	8,967	9,452	13,367	16,371
75 mm	3,451	rpm 4,227	4,881	5,457	5,978	6,457	6,903	7,321	7,717	10,914	13,367
100 mm	2,989	3,661	rpm 4,227	4,726	5,177	5,592	5,978	6,340	6,683	9,452	11,576
125 mm	2,673	3,274	3,781	rpm 4,227	4,630	5,001	5,347	5,671	5,978	8,454	10,354
150 mm	2,440	2,989	3,451	3,859	rpm 4,227	4,566	4,881	5,177	5,457	7,717	9,452
175 mm	2,259	2,767	3,195	3,572	3,913	rpm 4,227	4,519	4,793	5,052	7,145	8,751
200 mm	2,113	2,588	2,989	3,342	3,661	3,954	rpm 4,227	4,483	4,725	6,683	8,185
225 mm	1,993	2,440	2,818	3,151	3,451	3,728	3,985	rpm 4,227	4,456	6,301	7,717
250 mm	1,890	2,315	2,673	2,989	3,274	3,537	3,781	4,010	rpm 4,227	5,978	7,321

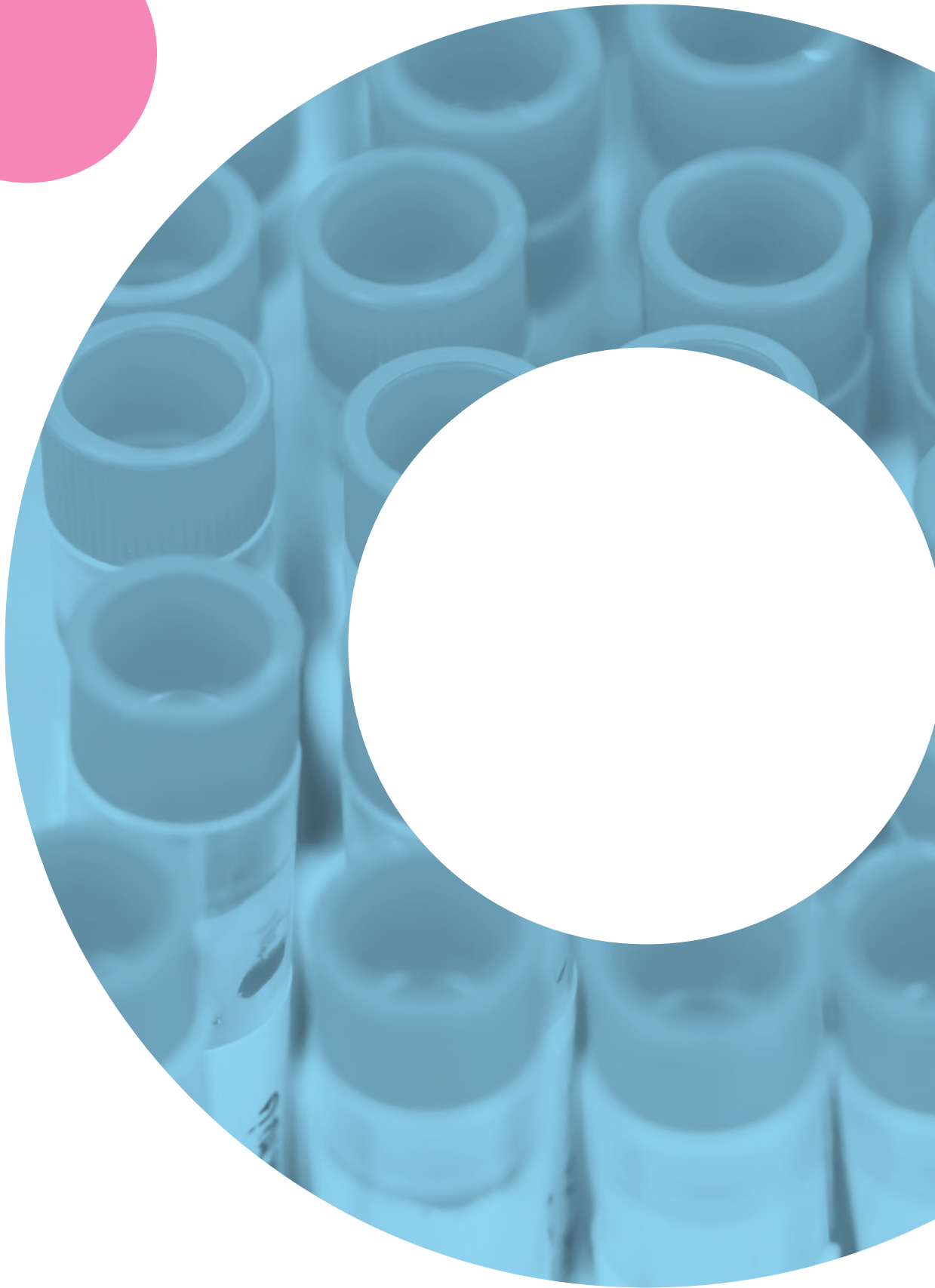
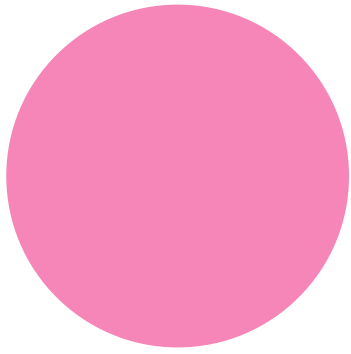

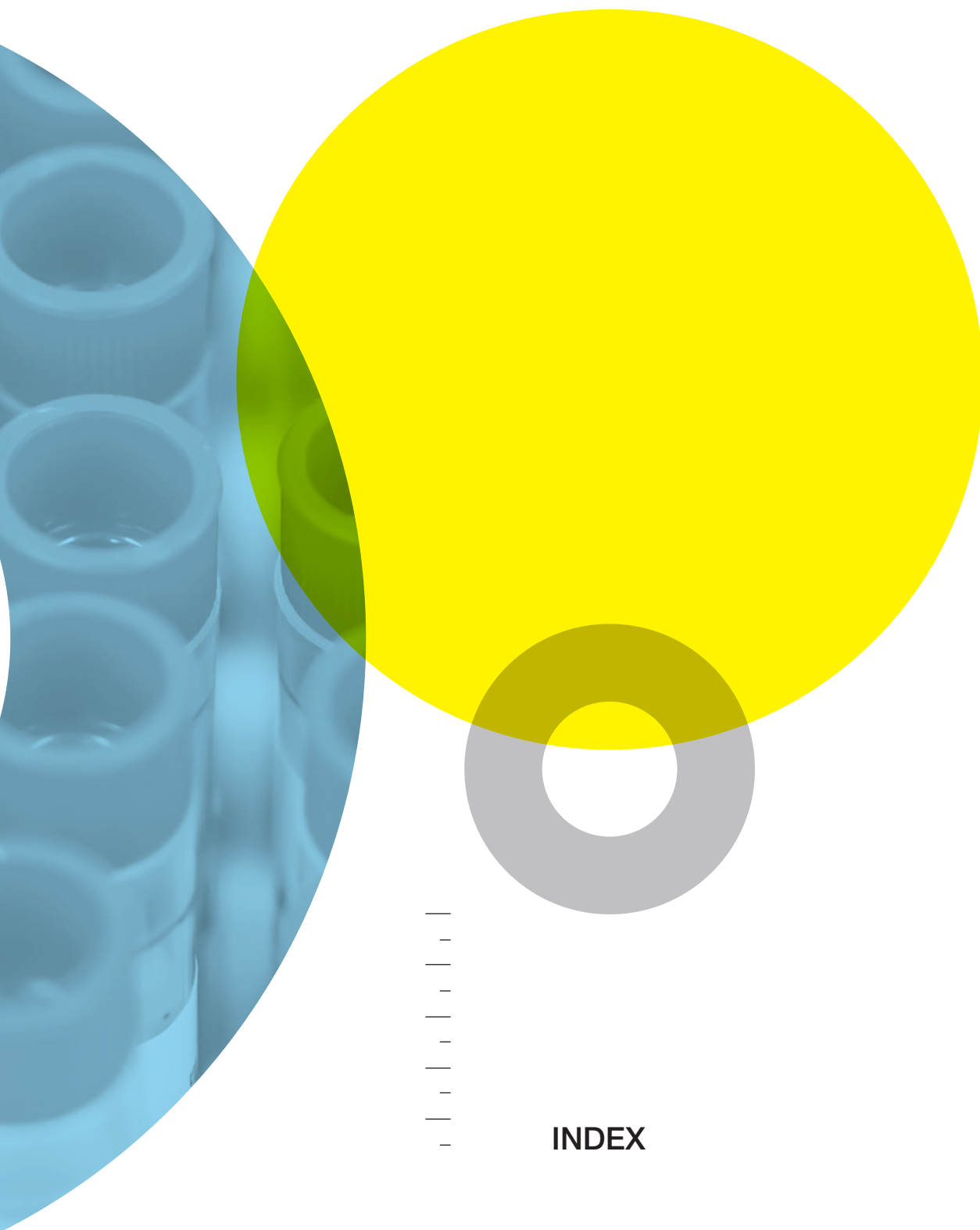

INDEX

 deltalab

Description	page
A	
Absorbent paper	252
ABS trays	266
Acetal polymer racks	226
Adhesion microscope slides	103
Adhesive labels	248
Adhesive sealing film	68
Aluminium racks 5 x 5 holes	231
Aluminium racks 10 x 5 holes	231
Aluminium sealing foil	68
Amies, swabs	20, 24
Analytical funnels	260
Anticoagulants and preservatives in containers	85
Assembling rack	225
Autoclave resistant red bags	247
Automatic slide dispenser	112
AYRE spatula	139
B	
Bags for Autoclave	247
Bags for STOMACHER® blenders sterile	43
Baskets for autoclave	236, 237
Beakers	278
Beakers with three spouts	259
Bed pan	253
Biopsy and tissue cassettes	98
Biopsy cassettes. Histosette I	96
Blood collection tubes	74, 83
Blood group test plate	82
Blood-plasma	79
Blue containers	124
Bottle carrier with folding handlers	236
Bottles	287
Bottles for sterilization	247
Bottles for water sampling	138
Bottles for water sampling sterile	45
Bottles with standard, narrow neck	282
Boric acid, bags and containers	47, 117
Broyeur de potter	44
Büchner funnels	261
Buckets with spout	280
Burette clamps	262
C	
Calibrated loops sterile	34
Canes for cryovials	167
Capillary tubes sealing wax	86

Description	page
Caps for screw thread microtubes	56, 57, 164, 165
Caps W-SEAL	170
Cardboard waste containers	245
Cary Blair	21, 24
Cassette for biopsy	95, 97
Cassettes for tissue	95, 96, 97
Cell and Tissue culture dishes	53
Cell and Tissue culture flasks	52
Cell and Tissue culture plates	52
Cell Scrapers	53
Cell strainer	53
Centrifugal tubes	37, 54, 150
Circular support to house 6 single-channel pipettes	194
Citrate for coagulation	75
Cuvette segments	88
Colorants pour Hématologie	86
Coloured adhesive tapes for sample identification	248
COMBI Rack for PCR tubes	221
Combi rack height 128	226
Composed Disconnectors / connectors	270
Conical high resistance tubes	40, 151
Conical measuring flasks	259
Conical tubes	146
Contact plates	31
Containers 150 ml	122, 123
Containers and tubes for vacuum system	126
Containers for urine sampling	116-131
Containers with seal and dropper	285
Coplin type staining jar	108
Coulter counter cups	89
Cryogenic storage boxes	173
Cryoinstant	168
Cryovials	58, 166, 167
Cuvette rack	222
Cylinder with handle	288
Cylindrical container	129
Cylindrical slide mailer	111
Cylindrical stirring bars	273
Cytology brush	139
D	
Decappers W-DECAP	172
Deep well plate	69
Dental containers	65-69
Digital timers	271
Digralsky spreader. Sterile	33

Description	page
Disposable cups	125, 278
Dividers to W-Coat and W-Coat AIY	173
Drums with tap	290
Drum with screen and childproof cap	288
Drying rack	264
E	
Emergency eyewash bottle	249
Enrichment media	26
Erlenmeyer flasks	257
EUROTUBO® 12 ml screw cap tubes, round bottom	36, 149
EUROTUBO® 15 ml and 50 ml conical tubes	39, 152
EUROTUBO® Pipetting bulb	42, 206, 250
EUROTUBO® slides	101
Extra long pipettes	202
F	
“Fast read” plate	88, 125
Filter paper	252
Flask weight ring	263
Flat bottom screw threaded vials	156
Flocked swab with media	23
Forceps	100
Funnels	260, 261, 292
G	
Giemsa solution	105
Glass Pasteur pipettes, closed tip	205, 206
Glucose solution for oral administration	75
Graduated beakers	258
Graduated measuring cylinders pentagonal base	256
Graduated narrow neck bottles	284
Graduated pipettes	199
Gram stain	105
H	
Hand operated capper W-CAPP10	172
Handrop® digital - MC	195
Handrop® digital - SC	195
Handrop® stand for pipettes	194
Handrop® stepper	195
Hexagonal weighing dishes	267
High speed funnels	260
Hinged lid container	132
Histology mould	94
Horizontal metal racks	173

Description	page
I	
«IMHOFF» sedimentation cone	261
Industrial drums	293
Industrial jugs	280
Instrument trays	236
Integral wash bottles	251
Iodoacetate lithium + heparin lithium tubes	78
Isofreeze Rack with temperature indicator	217
Isofreeze reversible racks with lid	218
Isothermal bags	138
J	
Jar for anaerobes incubation	30
Jars with lid	92, 279
L	
Laboratory holders	268
Laboratory spatulas	265
Laboratory storage cabinet	99
Large deep trays	292
Latex gloves	255
Lids for cassettes	95
LIM Broth	26
Liquid Amies. Sterile	20
Lithium heparin tubes	78
Long-handled dippers	47
Long-stem funnels	260
Low form graduated beakers	259
M	
Magnetic stirring bars	272
Mailing container	82
Main features	169
Management of traceability	171
May Grunwald solution	105
Measuring cylinders with pentagonal base	256
Measuring scoops	265
Meat sampling kit	49
Media for Chlamydia. Sterile	22
Media for virus. Sterile	22
Mega cassettes	97
Metalic cryoracks for sample storage	173
Metal tray histology	94
Microhaematocrit capillary tubes	86
Micropipettes	198
Microscope slide boxes	112
Microscope slide labels 23 x 23 mm	104

Description	page
Micro stirring bars	272
Microtitre plates, sterile	32
Microtube racks	215
Microtubes, with cap. Sterile	56, 57, 164
Modular storage	99
Mounting medium for microscopy	104
Multi Channel Pipette NICHIPET 7000	193
Multitips	192
N	
Narrow neck, high resistance bottles	284
Needle collection container	243
NICHIPET EXII	193
NICHIPET PREMIUM pipettes	193
Nichrome wire loops	33
Nitrile gloves	255
Non graduated serological pipettes	202
Nozzle bottles	286
O	
Our range	178
Ovoid stirring bars	272
P	
Paraffin	94
PCR sealing mat	68
PCR workstations	220
Petri Dishes	28, 29
Petri dish baskets	30, 239
Petri dish incubation tray	32
Pipette pumps	42, 207, 250
Pipetting bulb	42, 206, 207, 250
Pipette tips	178-191
Pipetting reservoir	188
Polypropylene containers	116, 117
Polystyrene racks for cryovials	210
PVC Antiacid trays	266
PVC Pipette tray	266
R	
Racks	212-229
Racks for bags	239
Racks for containers	120, 156, 233-235
Racks with lid	215
Real Time PCR	61
Re-caps	147
Rectangular bottles	286

Description	page
Rectangular containers, graduated up to 2 litres	130
Rectangular graduated until 3 litres container with handle	127
Rectangular waste containers (PP)	245
Reticulocyte staining kit	85
Reversible 96 well racks with lid	221
Reversible racks with removable handles	216
Rhomboid weighing dishes	267
Robotic and conductive tips for TECAN	196
Robotic Tips for Hamilton (300µl and 1,000µl)	197
Robotic Tips for Qiagen (300µl and 1,100µl)	197
Rotary pipette stand	262
Round baskets with handle	237
Round bottom glass tubes	154
Round bottom polystyrene tubes	142, 143
Round bottom tubes capped	145
S	
Safety containers	242-244
Safety glasses	249
Safety gloves	254
Safety labelling	243
Sample cups	88
Sample storage system	70, 71, 174, 175
Scintillation vials	89
Screw thread microtubes	164, 165
Security screw cap containers	93, 128, 133
Sedirate micro system	80
Selenite	26
Self sealing security jars	281
Serum glucose serotub	75
Silicone sheets, tubing	269
Slide boxes, folders, mailers	109-112
Slide printer microscope slides	103
Slide storage boxes	111, 112
Slide storage system. Stackable	113
Slide tray	109
Specimen transport kangaroo bags	136
Spectrophotometer cuvettes	87
Square baskets	237
Square containers	281
Squared bottles	287
Stackable drums	289-291
Stacking PCR work up rack	221
Staining	106-108
Stainings racks for microscope slides	239
Staining tray	104
Stainless steel basket for blood collection	238

Description	page
Stainless steel racks	230-232
Stains	105
Standard 1.5 ml microtubes	158
STAR FROST® ADHESIVE slides	102
STAR FROST® slides	102
Sterile Whirl-Pak® sampling bags	135
Sterile culture tubes in polystyrene	36, 55, 149
Sterile homogeniser filter bag	44
Sterile serological pipettes	41
Sterilization indicator tapes	246
Stirring bar retriever	272
Streaking needles	34
Stuart swabs. Sterile	21
Styrofoam racks	219
Surface Kit	49
Swabs	14, 16
Swab in round tube	18
Swabs sterile	17
Swabs with transport media	19
Syringes	82, 137
T	
Tamper evident bottles, buckets	92, 279, 285
Tamper evident microtubes	57, 165
Thioglycolat	26
Timer	271
Tips	178-191
Tongue depressors	252
Tourniquet	74

Description	page
U	
Universal racks	223
Universal test tube racks	224
Urine collection bottle	253
Urine container set	125
V	
Vacuum filtration	54
Vacuum pump	263
Vaginal speculum	139
VICUM® swabs	25
Virus swabs	25
Volumetric flasks	257
W	
W-2D Tubes with 2D Datamatrix codification	171
W-2DRP Tubes with codification and Right Position System	171
Wash bottles	251
Watch glasses	267
Whirl-Pak® bags with flat wires	134-136
Whirl-Pak® blender bags with and without filter Sterile	43
Wide mouth drums with security cap	289-292
Weighing dishes	267
Wide mouth jars with lid and insert plug	276
Wilmut	169-172
W-PICKER	172
Z	
Ziehl stain	105



code	page	code	page	code	page	code	page
00-NPM-12K	193	191108	107	191623	282	192562	256
00-NPM-12L	193	1911103	267	191625	282	192563	256
00-NPM-8K	193	1911104	267	191627	282	192564	256
00-NPM-8L	193	1911105	267	191629	282	192565	256
1000LG	255	1911106	267	191631	282	192566	256
1000LM	255	1911107	267	191633	251	192567	256
1000LP	255	1911108	267	191634	251	192572	256
1000LSP	255	1911110	267	191637	251	192573	256
1020LG	255	1911111	267	191637.04	251	192574	256
1020LM	255	1911112	267	191637.06	251	192575	256
1020LP	255	1911114	267	191637.10	251	192576	256
1164	89	191220	248	191638	251	19262	262
120002	252	191221.1	248	191638.04	251	19265	262
120003	252	191221.2	248	191638.06	251	19266	262
120010	252	191221.3	248	191638.10	251	19267	262
122000	44	191221.4	248	19164	260	19270	254
128030	82	191221.5	248	191640	290	19274.5	113
132832	81	191221.6	248	191642	290	19276.1	112
1360	81	191221/1	248	191646	290	19276.A	111
1361	81	191221/2	248	19166	261	19276.B	111
141746	88, 125	191221/3	248	19167	261	19277	112
15001	43	191221/4	248	19168	261	19277.1	112
15003	43	191221/5	248	19169	261	19277.B	111
15004	43	191221/6	248	19172	260	19278	112
15005	44	191222	246	191721	258	19278.2	112
15006	43, 239	191223	246	191722	258	19278.3	112
1501118	83	19139	262	191723	258	19278.A	111
1501308	83	191395	263	191724	258	19278.B	111
1501418	83	19140	262	191725	258	19279.3	113
1501818	83	19146	260	191726	258	19279.5	113
162005	189	191461	257	191727	258	19279.7	113
191050	246	191462	257	19173	260	19280	266
191051	246	191463	257	19174	260	19281	266
191052	246	191464	257	19175	260	19282	266
191055	261	191465	257	191822	258	19283	266
191056	261	19147	260	191823	258	19284	266
191057	265	19148	260	191824	258	19285	266
191058	265	191484	257	191825	258	192922.04	94
191059	265	191485	257	191826	258	192932	94
191060	265	191486	257	191827	258	192933	94
191062	265	191487	257	191828	258	192934	94
191063	265	191488	257	191829	258	192935	94
191064	265	191489	257	19195	206	192950	95
191065	265	19150	260	19200	42, 206, 250	192951	95
191066	265	19152	260	19201	42, 207, 250	192952	95
191067	265	19153	260	19212	264	19319	284
191068	265	191537	259	19213	264	19323	284
191069	265	191578	288	19215	263	19324	284
191070	265	191579	288	19217	263	193241	284
191071	265	191597	282	19218	263	19325	284
191087	108	191601	282	19219	263	193251	284
191100	106	191603	282	19221	263	19326	284
191101	106	191610	282	192470	263	19351	106
191104	107	191612	282	192471	263	19353	107
191105	107	191614	282	192472	263	19354	107
191106	107	191616	282	19252	203, 266	19355	106
191107	107	191618	282	19254	262	19360	108

code	page	code	page	code	page	code	page
19361	108	19570	225	19905	280	200032.0	199
19375	290	195703	266	19906	280	200034	199
19384	249	195705	266	19907	280	200037	199
19385	249	195706	266	199075	189	200038	200
19386	249	195707	266	199076RC	184	200050	202
193914	206	195709	266	199078N	181	200060	202
19400	271	195711	266	199078RC	181	200062.0	199
19400.1	271	195713	266	199083	183	200070	185
19408	283	19575	47	199084RC	179	200070NR	185
19409	283	19576	47	19919	272	200070R	185
19410	283	19577	47	19922	111	200071	186
19411	283	19586	253	19923	110	200071NR	186
19412	283	19591	253	19924	110	200072	181
194171	260	19591/T	253	19926	110	200074	184
194172	260, 292	19593	265	19971	268	200075	189
194173	260	19596	265	19972	268	200075RF	189
194175	260, 292	19603	292	19973	222	200076	184
194176	260, 292	19604	292	19996	203, 266	200076R	184
194177	260, 292	19605	292	200000	200	200076RF	184
194178	260, 292	196102	44	200001	200	200077	185
19418	270	196105	44	200002	199	200077F	185
19423	259	196110	44	200003	199	200077FR	185
19424	259	196115	44	200004	199	200077R	185
19425	259	196302	44	200005	200	200078	181
19435	270	196305	44	200006	199	200079	182
19438	261	196310	44	200007	199	200079FS	182
19440	261	196315	44	200008	200	200079R	182
19441	261	19660	290	200009	183	200080.1	186
19442	261	19662	290	200009B	183	200080.1R	186
19443	261	19664	290	200009R	183	200082	186
19445	261	19666	290	200010FR	180	200082F	186
19454	267	19698	273	200012	185	200082NR	186
19455	267	19700	236	200012B	185	200082R	186
19460	268	19705	273	200012R	185	200083	190
19461	268	19748	273	200014	191	200083R	190
19462	268	19750	273	200014FR	191	200100	247
19465	268	19751	273	200014R	191	200103	89
19467	268	19753	273	200015	191	200121	200
19468	268	19756	273	200015R	191	200200	28
19500	100	19757	273	200015RF	191	200200.4	28
19501	100	19758	273	200016	181	200200.5	29
19503	100	19763	273	200016B	181	200200H	29
19504	268	19764	273	200016R	181	200201	29
19505	268	19786	273	200017	184	200201.B	29
19510	270	19787	273	200018	187	200202	28
19512	270	19788	273	200019	185	200203	28
19513	270	19793	273	200020	187	200204	29
19535	270	19797	273	200021	187	200208	31
19538	270	19806	272	200024	179	200209	28
19539	270	19810	273	200026	182	200210	28
19540	112	19811	273	200028	190	200214	29
19563	225	19852	272	200028R	190	200215	28
19564	225	19855	272	200028RF	190	200218	31
19565	225	19856	272	200029	186	200219	29
19566	225	19901	271	200029F	186	200310	247
19567	225	199014N	181	200029R	186	200311	247
19568	225	199014RC	181	200029RF	186	200312	247

code	page	code	page	code	page	code	page
200318	247	202630	291	210005	198	282324	45
200320	247	202705	289	210006	202	282324.BU	45
200321	247	202710	289	210022	201	282330	45
200322	247	202801	92, 276	210023	201	282331	45
200325	135	202802	92, 276	210024	201	282333	45
200326	135	202802.1	276	210030	198	282334	45
200329	135	202802B	276	222802	92, 279	282340	48
200330	135	202803	92, 276	222803	92, 279	282341	48
200332	135	202804	277	222804	92, 279	282350	48
200333	135	202808	92, 276	222805	92, 279	282351	48
200340	135	202809	92, 276	232801	244	29	81
200341	135	202810	92, 276	232802	244	292300	285
200342	43, 135	202811	92, 276	232806	244	292303	285
200343	43, 135	202813	92, 277	232808	244	292304	285
200345	135	202813.10	277	232809	244	292305	285
200346	135	202814	276, 92	232810	244	292306	285
200347	135	202814.1	276	232811	244	292601	47
200349	135	202815	277	240007	242	292602	47
200351	43, 135	202815B.0	277	240011	243	292605	47
200356	134	202818	92, 277	240021	243	292606	47
200357	135	202820	277	240028	243	292819	287
200358	135	202820.0	277	240035	245	292819G	286
200359	135	202821	92, 277	240065	245	292820	287
200361	134	202821.1	277	241010	92, 279	292820G	286
200363	135	202821.0	277	241011	92, 279	292821	287
200364	135	202823	277	241013	92, 279	292821G	286
200365	134	202823.1	277	241014	92, 279	300100	143
200372	135	202828	277	241015	92, 279	300200	17
200373	43	202828G	277	242000	242	300201	17
200374	43	202839*	277	242801	278	300202	17
200376	43	202840	128	242802	278	300203	17
200381	46	202841	128	242803	278	300205	16
200382	46	202842	128	242804	278	300210	17
200383	46	202843	128	242805	278	300212.1	17
200393.V	49	202844	128	242806	278	300230	16
200393P	49	202845	93	242811	278	300232	16
200396P	49	202846	93	243500	242	300243	16
200398	49	202847	93	244109	219	300250	18
200399	49	202848	128	244111	219	300250.1	18
200400	158	202911N	281	246000	242	300251	18
200400P	158	202912N	281	250050	245	300252	18
200401	158	202913N	281	260000	244	300252DNA	18, 58
200405	158	202914N	281	27	80	300253	18
200407	158	202915N	281	270050	245	300260	16
200410	158	202916N	281	272301	286	300260.1	16
200420	219	206020	289	272303	286	300261	18
200500.1	33	206025	289	272304	286	300263	18
200510.1	33	208030	293	282303	285	300265	18
201110	198	208031	293	282304	285	300280	21
201250	198	208060	293	282305	285	300280.2	21
202248	125, 278	208061	293	282306	285	300281	20
202317	125, 278	208128	293	282310	287	300281/1	20
202505	288	209030	292	282311	287	300284	20
202605	291	209050	292	282320	45	300285	20
202610	291	210002	201	282321	45	300287	20
202620	291	210003	201	282323	45	300290	21
202625	291	210004	201	282323.BU	45	300291	21

INDEX BY CODE

code	page	code	page	code	page	code	page
300294	22	303101	87	310202	17	350024	269
300295	21	303102	87	316-313.1	192	350034	269
300297	22	303103	87	316-313.2	192	350035	269
300299	22	304000	87	316-314.1	192	350037	269
300300	142	304210	26	316-314.2	192	350046	269
300400	142	304211	26	316-315.1	192	350048	269
300500	142	304212	26	316-315.2	192	350051	269
300700	143	304270	25	316-316.1	192	350057	269
300702	145	304271	25	316-316.2	192	350059	269
300704	145	304273	25	316-317.1	192	350069	269
300705	143	304273.2S	25	316-317.2	192	350079	269
300800	142	304276	25	316-318.1	192	350610	269
300800.1	142	304278	25	316-318.2	192	350612	269
300800.2	142	304279	25	316-319.1	192	350710	269
300807	36, 55, 149	304280	24	316-319.2	192	350810	269
300808	36, 55, 149	304281	24	317-314.1	192	350812	269
300900	143	304282	24	317-315.1	192	350814	269
300903	145	304285	24	317-316.1	192	350912	269
300904	145	304286	24	317-317.1	192	350915	269
300907	145	304287	24	317-318.1	192	351014	269
300908	145	304288	24	317-319.1	192	351420	269
301-01	179	304291	25	318000	197	351622	269
301-01F	179	304295	25	318001	197	352030	269
301-01FR	179	304297	25	318002	196	400400	144
301-01R	179	3050	147	318003	196	400500	144
301-09	179	3053	147	318005	196	400700	144
301-10	179	3055	147	318006	196	400705	144
301-11	179	3058	147	318008	197	400800	144
301200	146	3066	147	318009	197	400800.1	144
301201	146	3070	147	318102	196	400900	144
301202	146	3071	147	318103	196	401100	144
301212	146	307107	147	319324.E10	125	401200*	146
301213	146	3072	147	319324.E13	125	401200	146
301402	36, 149	3081	147	326-19	179	401201	146
301403	36, 149	308102	147	326-37	179	401201	146
301700	143	308107	147	327-16	186	401204	146
302000	87	3082	147	327-19	179	401204	146
302100	87	308202	147	327-23	180	401301	82
302400	87	308207	147	327-24	180	401302	82
302713	34	308502	147	327-26	182	401402	36, 149
302714	34	308506	147	327-30	185	401403	36, 149
302733	34	308602	147	327-30R	185	401410	58, 166
302734	34	308606	147	327-31R	186	401700	144
302743	35	309202	116	327-33	181	402001	247
302744	35	309222	116	327-33R	181	402002	247
302745	35	309222.0	116	327-34	181	402005	247
302753	35	309316	125	327-34R	181	402010	247
302754	35	309324	125	327-36	180	402020	247
302755	35	309324.E3	125	327-36R	180	4020NG	255
302762	33	309324.PS	125	327-37R	179	4020NM	255
302764	33	309402	118	327-40	183	4020NP	255
302771	33	309502	120	330	223	407001	130
302772	33	309526	120	330089	188	407001/T	130
302780	33	309552	120	330129	188	407001OBT	130
302792	33	309752	122	350002	269	407003	130
302794	33	309903	124	350004	269	407005	131
303100	87	310200	17	350013	269	407005.0	131

code	page	code	page	code	page	code	page
407005/T	131	409050	258	4092.3N	160	409756	122
407006	131	4091.1N	159	4092.3NS	160	409756.B	122
407006/T	131	409100	258	4092.4N	159	409802	118
407008	130	409102.1	167	4092.5N	159	409826	118
407008.O	130	409103.1	58, 166	4092.6N	160	409852	118
407008OBT	130	409104.1	167	4092.6NS	160	409902	124
408001	129	409105.1	58, 166	4092.7N	161	409920	40, 151
408001.1	129	409106.1	58, 166	4092.8N	161	409922	40, 151
408001.O	129	409106.2	167	409202	117	410046	132
408001-86	129	409107	58, 166	409202.B	117	410056	132
4080010/T	129	409107.1	167	409222	117	418003	71, 175
4080010BT	129	409108	58, 166	409222.O	117	419802	119
408002	71, 175	409108.1	167	409250	258	419826	119
408003	71, 175	409109	58, 166	4094.1A	59	429900	39, 152
408005	71, 175	409109.1	167	4094.1AM	59	429900SP	39, 152
408025	256	409110	167	4094.1N	59	429901	39, 152
408050	256	409110.1	56, 164	4094.1R	59	429910	38, 152
408100	256	409110.2	56, 164	4094.2A	62	429920	38, 152
408250	256	409110.2T	57, 165	4094.2AM	62	429926	39, 152
408500	256	409110.3	56, 164	4094.2N	62	429926.10	39, 152
408600	127	409110.4	56, 164	4094.2R	62	429926.25	39, 152
408601	127	409110.4T	57, 165	4094.3N	60	429927	39, 152
408610	127	409110/1	167	4094.4N	60	429927.10	39, 152
408702	126	409110/4	167	4094.5BP	61	429927.25	39, 152
408702.G	126	409111/2	57, 165	4094.5N	59	429930	37, 54, 150
408711	126	409111/3	57, 165	409402	118	429931	37, 54, 150
408720	126	409111/4	57, 165	409426	118	429940	37, 54, 150
408721	126	409111/5	57, 165	4095.1BP	61	429942	37, 54, 150
408726	126	409111/6	57, 165	4095.1N	60	429945	37, 54, 150
408726.G	126	409111/7	57, 165	4095.1NP	60	429946	38, 152
408900.K	126	409111R	56, 164	4095.2N	60	429950	37, 54, 150
408910.K	126	409112/0	57, 165	4095.4N	60	429951	37, 54, 150
408914	127	409112/1	57, 165	4095.5N	62	430100.1	133
408922	127	409112/2	57, 165	4095.6N	60	430130	133
409001	58, 166	409112/4	57, 165	4095.7N	60	430130.1	133
409002	58, 166	409112/6	57, 165	4095.9N	59	439905	151
409002.1	58, 166	409113.1	56, 164	409500	258	439910	151
409003	58, 166	409113.2	56, 164	409501	121	440131	94
409003.1	58, 166	409113.3	56, 164	409502	121	440132	94
409003.2	58, 166	409113.4	56, 164	409502G	121	440139	94
409003A	166	409113/1	27, 168	409511	124	440139D	94
409003AM	166	409113/2	27, 168	409526	121	440141	95
409003R	166	409113/3	27, 168	409526.1	121	440142	139
409003V	166	409113/4	27, 168	409526.O	121	440142.0	139
409004	71, 175	409113/5	27, 168	409526G	121	440143	95
409005	70, 170, 174	409113/6	27, 168	409552	121	440144	95
409007.M	56, 164	409115/2	56, 164	4096.2N	60	440147	95
409007.N	56, 164	409115/3	56, 164	4096.3N	60	440149	95
409008	70, 174	409115/4	56, 164	409602	117	440150	139
409008.M	56, 164	409115/6	56, 164	409700	122	440151	139
409008.N	56, 164	409120	167	409701	123	440157	139
409009	70, 174	409132	167	409702	123	440158	139
409010	70, 174	409133	167	409703	123	440159	139
409011	70, 174	409135	167	409711	124	441142	252
409012	70, 174	4092.1N	158	409726	123	441142.1	252
409013	70, 174	4092.1NS	158	409726.G	123	441142.2	252
409014	70, 174	4092.2N	160	409752	122	441242.2	252

INDEX BY CODE

code	page	code	page	code	page	code	page
44125	97	490400	259	702	205	816160	154
44140	97	490900	259	705000	85	818150	154
44141	97	491000	258	705595	147	820150	154
44143	97	492000	258	705722	147	820200	154
44145	97	493000	258	707094	77	845	70, 174
44147	97	495000	258	712	205	900007	157
44240	95	53020	285	713100	155	900008	89
44245	95	53125	285	716100	155	900010	32
44260000	284	53250	285	716125	155	900010.1	32
44270000	284	554140	96	716150	155	900011	32
44280000	284	554141	96	720150	155	900011.1	32
44300000	251	554147	96	721008	195	900012	32
44310000	251	554148	96	7301	86	900012.1	32
44330000	251	555260	98	7311	86	900015	32
444142	139	555261	98	7401	86	900015.1	32
444150	139	555262	98	7411	86	900019	88
444242	139	555263	98	7600	86	900020	89
44430000	283	555264	98	770000	195	900022	88
44440000	283	555265	98	770005	195	900023	88
44450000	283	600300	77	770040	195	900024	88
44460000	283	600400	77	770050	195	900025	110
444602801	133	600602	75	770060	195	900028	110
444602901	133	600800	76	770070	195	900030.C	41, 55, 204
444602903	133	600801	76	770080	195	900031.C	41, 55, 204
444603202	133	601006	80, 81	770110	195	900032.1C	202
444603204	133	601102	75	770210	195	900032.C	41, 55, 204
444603300	133	601103	75	770220	195	900033.C	41, 55, 204
444603402	133	601402	79	770240	195	900034.C	41, 55, 204
444608	281	601412	79	770310	195	900036.C	41, 55, 204
444609	281	601413	79	770320	195	900037.C	41, 55, 204
444610	281	601603	79	770340	195	900038.C	41, 55, 204
444611	281	601613	79	800000	85	900041.C	41, 55, 204
444612	281	601702	79	801000	85	900043.C	41, 55, 204
444613	281	601802	78	801075	154	900050	203
444614	281	601803	78	801175T	154	900073	138
44470000	283	601810	78	801275	154	900074	138
445140	97	602002	78	802000	85	900076	138
445141	97	602003	78	805001	105	900078	138
445143	97	611603	79	805011	105	900093	65
445145	97	611604	79	805013	86, 105	900095	65
445147	97	617000	155	805020	105	900098	65
454140	96	617100	155	805030	105	900100	89
454141	96	617145	155	805040	105	900101	89
454147	96	617200	155	805050	105	900110	66
454148	96	617300	155	805120	105	900111	66
454241	96	617402	153	805130	105	900112	67
470000	280	620200	83	805140	105	900113B	67
470001	280	620400	83	805150	105	900117	157
470002	280	621101	83	806030	105	900118	157
470003	280	621610	83	808000	86, 105	900122	66
470005	280	621611	83	808001	86, 105	900123	65
470007	280	621613	83	808100	86, 105	900130.C	41, 55, 204
481000	256	662005	189	808101	86, 105	900136.C	41, 55, 204
482000	256	668811	34	808200	86, 105	900144.C	41, 55, 204
490050	259	701	205	813100	154	900146.C	41, 55, 204
490100	259	701034	147	816100	154	900156	69
490250	259	701061	147	816150	154	900170	69

code	page	code	page	code	page	code	page
900198	69	A100014	102	D200001	52	H-240	237
900204	156	A100018	102	D200002	52	H-260	236
900205	156	A100019	102	D200003	52	H-261	236
900211	156	A-200	232	D200004	52	H-290	237
900212	156	A-201	232	D200005	52	H-295	237
900220	156	A20100	104	D200010	52	H-401	238
900225	156	A-202	232	D200011	52	H-600	30, 239
900300	68	A20250	104	D200012	52	H-601	30, 239
900301	68	A20500	104	D200013	52	H-610	31
900305	68	A-210	232	D200014	52	H-611	31
900306	69	A-211	232	D200015	52	H-615	32
900310	69	A-212	232	D200020	52	H-625	30
900320	68	A-222	232	D200021	52	I-240	120, 235
900330	68	A-230	232	D200022	52	I-250	120, 235
900384	62	A-231	232	D200023	52	JS1	82, 137
900400	271	A-240	232	D200024	52	JS2	82, 137
900600	271	A-241	232	D200025	52	JS3	82, 137
901030	248	A-242	232	D200030	53	JS4	82, 137
901031	248	A-250	232	D200031	53	JS5	82, 137
901031.2	248	A-251	232	D200032	53	JS6	82, 137
901075	154	A-260	232	D200033	53	JS8	82, 137
901275	154	B-200	232	D200034	53	JS9	82, 137
901407	226	B-210	232	D200035	53	L-240	235
901410	226	B-220	232	D200060	53	L-250	235
901531	243	B-240	232	D200100	53	M 100150	136
901533	243	C-200	233	D200150	53	M 100150B	136
901600	104	C-211	233	D-230	156, 233	M 110110	136
910022	88	C-254	233	D-240	156, 233	M 120180	136
910023	89	C-256	233	D-250	156, 233	M 120180B	136
910026	89	C02	253	D300000	54	M 150220	136
913100	154	CP-30 H	108, 239	D300001	54	M 160220B	136
916100	154	CP-30	108, 239	D300002	54	M 180250	136
916150	154	CP-45 H	108, 239	D300003	54	M 180250B	136
917000	156	D01	253	D300004	54	M 200300	136
918000	156	D03	253	D300005	54	M 200300B	136
918150	154	D100001	101	DS10	99	M 250330	136
922000	156	D100002	101	DS36	99	M 300400	136
928000	156	D100003	101	DS40	100	M 5555	136
979930	110	D100004	101	DS42	100	M 5555B	136
983045	44	D100005	101	DS51	99	M 6080	136
983047	43, 239	D100006	101	DS52	99	M 6080B	136
986517	75	D100010	103	DS63	99	M 70100	136
986524	75	D100011	103	F-200	232	M 70110B	136
989901	110	D100018	103	F-210	232	M 80120	136
989902	110	D100019	103	F-211	232	M 80120B	136
989910	109	D100020	103	F-240	232	M 80160	136
989919	109	D100021	103	FB534S	173	M-010.1	216
989921	109	D101818	101	FB544S	173	M-010.2	216
989945	109	D102020	101	FB545S	173	M-010.5	216
989951	104	D102222	101	G-050	219	M-010.6	216
989952	104	D102240	101	G-100	219	M-010.7	216
989953	104	D102424	101	GS-01	74	M-011.1	216
989956	109	D102432	101	GS-02	74	M-015	220
999802	194	D102440	101	H-200	237	M-020AM	212
A100010	102	D102450	101	H-210	237	M-020N	212
A100011	102	D102460	101	H-215	237	M-020R	212
A100013	102	D-200	156, 233	H-220	237	M-020V	212

code	page	code	page	code	page	code	page
M-021AM	221	M-552	220	T-210	236	W053960CL	171
M-021R	221	M-553	220	TQ	74	W058100	169
M-021V	221	M-554	221	U-0537A	214	W-100	42, 207, 250
M-022	218	M-560A	226	U-0537N	214	W-110	42, 207, 250
M-024	218	M-561A	226	U-105105A	229	W-120	42, 207, 250
M-026	218	M-563A	216	U-1145A	227	W122960CL	171
M-028.5	219	M-563NA	216	U-1145N	227	W123100	171
M-028.6	219	M-570	218	U-1170A	227	W123960CL	171
M-033AM	211	M-571	218	U-1170N	227	W128100	169
M-033R	211	M-572	217	U-15128A	229	W128960	169
M-033V	211	M-581	217	U-15128AM	229	W-150	250
M-034AM	211	M-585	217	U-15128N	229	W310900	173
M-035AM	211	M-600	214	U-4445A	214	W310990	173
M-035R	211	M-603	214	U-4445N	214	W350900	173
M-035V	211	M-604	214	U-50128A	226	W350990	173
M-036AM	210	M-606	214	U-50128R	226	W370900	173
M-036B	210	M-607	214	U-50128V	226	W370990	173
M-050	222	M-610	214	U-7750A	213	W990000	170
M-052	215	M-640	221	U-7750N	213	W990001	170
M-053	215	M-641	221	U-7780A	228	W990002	170
M-060	222	MLTSTD2	194	U-7780N	228	W990003	170
M-061AM	210	N 160230	136	U-7780NA	228	W990004	170
M-061NA	210	N-240	235	U-7796V	228	W999600	170
M-062B	210	N-250	235	U-8845A	213	W999601	170
M-062R	210	NPP-10	193	U-8850A	213	W999602	170
M-063B	210	NPP-100	193	U-9581N	212	W999603	170
M-063R	210	NPP-1000	193	U-9950CAM	212	W999604	170
M-064AM	210	NPP-10000	193	U-9950CN	212	Z-050	231
M-064V	210	NPP-2	193	U-9950CNA	212	Z-075	231
M-100	222	NPP-20	193	U-9950CR	212	Z-100	231
M-201	188	NPP-200	193	U-9950CV	212	Z-250	231
M-203	188	NPP-5000	193	U-9970A	227	Z-300	231
M-205	188	NPX2-10	193	U-9980A	228	Z-500	231
M-211	188	NPX2-100	193	U-9980N	228	Z-550	231
M-212	188	NPX2-1000	193	U-9996A	229	Z-600	231
M-213	188	NPX2-10ML	193	U-9996N	229	Z-700	231
M-300	238	NPX2-2	193	V 160230	136	Z-800	231
M-410	215	NPX2-20	193	W000010	172		
M-450	215	NPX2-200	193	W000011	172		
M-500	215	NPX2-5000	193	W000018	172		
M-501	215	NT-250	235	W000040	172		
M-502	215	R-200	237	W000050	170		
M-503	215	R-215	237	W000059CL	170		
M-510	215	R-220	237	W000120	170		
M-511	215	R-230	237	W000129CL	170		
M-512	215	R-240	237	W001400	172		
M-513	215	R-250	237	W009680	172		
M-520	223	R-281	234	W-011	224		
M-521	223	R-282	234	W-012	224		
M-522	223	R-283	234	W-014	224		
M-523	223	R-292	234	W-015	224		
M-530	223	R-293	234	W-017	224		
M-540	220	RC845TP	70, 174	W-018	224		
M-541	220	S-002	108, 239	W030940	173		
M-542	220	S-003	108, 239	W031230	173		
M-550	220	S-004	108, 239	W052960CL	171		
M-551	220	T-200	236	W053100	171		

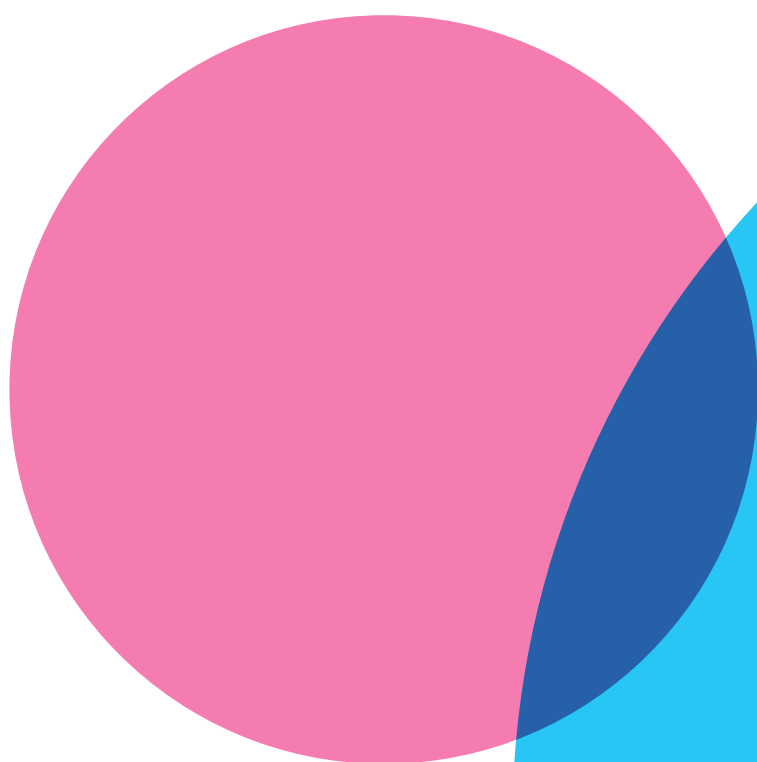

Direction and coordination
Marketing Department, DELTALAB S.L.

Photography
DELTALAB S.L. files
Christian Ribas

Graphic concept, design and digital image
ELIPTIC GROUP DESIGN S.L.

Printed by
VANGUARD GRÀFIC S.A.

Printed in Spain

November, 2019

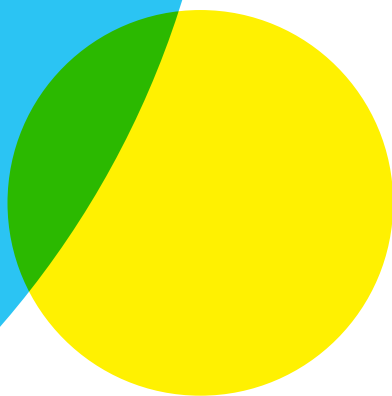

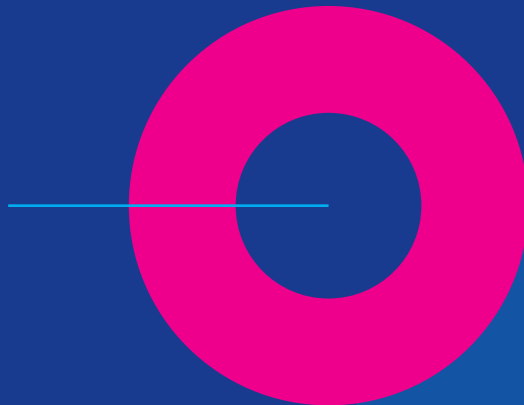
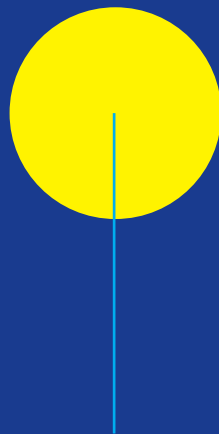

Plaza de la Verneda, 1 P. I. La Llana · 08191 Rubí · Barcelona · España

T. +34 699 50 00 · F. +34 699 45 12

www.deltalab.es · deltalab@deltalab.es